

OWNER'S MANUAL 193111-068

Revised February 8, 2011

IMPORTANT: Read these instructions before installing, operating, or servicing this system.

ULTRA CHARGE

Battery Charger

DO NOT DESTROY

AMETEK/PRESTOLITE POWER , TROY, OHIO 45373-1099, U.S.A.

NOTE: Information regarding obtaining additional copies of this manual is located in the Introduction chapter of this manual.

A battery charger is identified by model number. Incorporated into the model number is the 8-hour ampere-hour capacity, case size, input power phase, and maximum number of cells in battery for which charger is intended. The following example explains the basic model numbering arrangement.

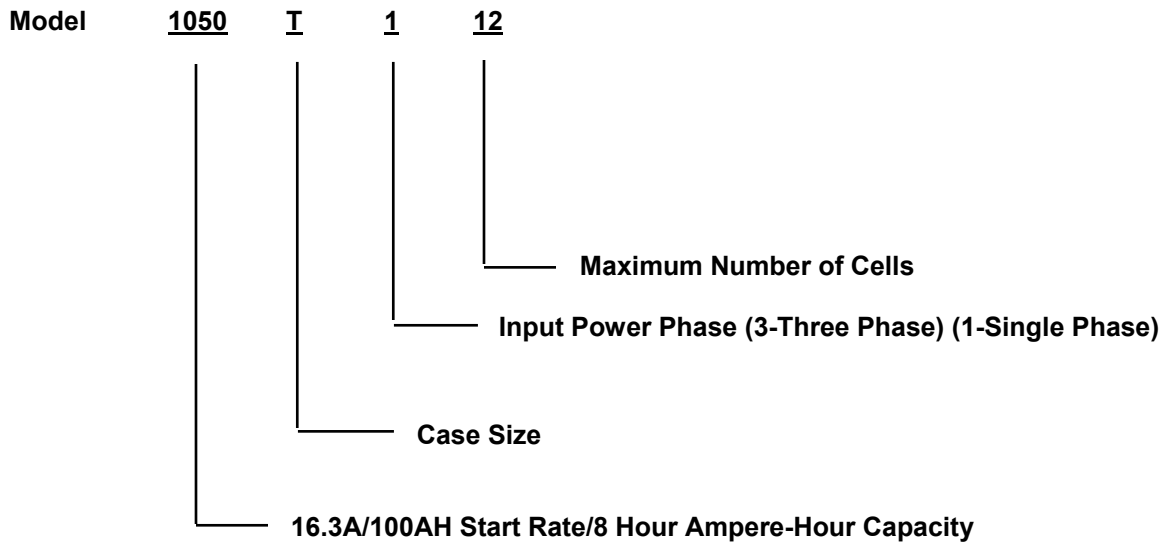

NOTE: This information is required for ordering certain replacement/service parts.

INTRODUCTION	1
How To Use This Manual	1-1
Equipment Identification	1-1
Receipt Of Equipment.....	1-1
SAFETY INSTRUCTIONS AND WARNINGS	2
DESCRIPTION OF EQUIPMENT	3
Operating Modes	3-1
User Selectable Output Curves	3-1
UC2000 Control.....	3-2
INSTALLATION	4
Location	4-1
Environmental Characteristics	4-1
Grounding.....	4-1
Line Voltage Changeover Instructions.....	4-2
Line Connections to Battery Charger.....	4-2
Charging Cable Connectors	4-3
Pre-operation Checks.....	4-3
Pre-Operation Changes to the Factory Control Settings	4-3
MAINTENANCE	5
OPERATION	6
Preliminary.....	6-1
Normal Or Daily Charge	6-1
Equalize Or Weekend Charge.....	6-2
Manual Stop.....	6-2
AC Power Fail.....	6-2
UC2000 CONTROL FEATURES	7
Main Features.....	7-1
Description of Features.....	7-2
UC2000 Charge Archive Function	7-5
UC2000 Charge Cycle Review Function	7-6
PROGRAMMING YOUR UC2000 CONTROL	8
OPTIONS	9
Parallel Charging	9-1
Series Charging	9-1
Fused Disconnect Switch	9-2
CDAC Expansion Kit.....	9-2
Remote Display kit.....	9-2
Wall Mounting Bracket.....	9-3
Lifting Eye Kit.....	9-3
Archive Downloading Kit	9-3
Remote Stop Pushbutton Kit.....	9-3

TROUBLESHOOTING **10**
 Troubleshooting Table..... 10-1
 Action 10-10

PARTS LIST **11**

DIAGRAMS

WARRANTY

INTRODUCTION

How To Use This Manual

IMPORTANT: It is especially important that all charger internal components be kept clean and dry, and all electrical connections tightened. Replace any precautionary or instruction label that cannot be easily read.

To ensure safe operation, read the entire manual, including the chapter on safety instructions and warnings.

Throughout this manual, the words **WARNING**, **CAUTION**, and **NOTE** may appear. Pay particular attention to the information provided under these headings. These special annotations are easily recognized as follows:

WARNING gives information regarding possible personal injury. Warnings will be enclosed in a box such as this.

CAUTION refers to possible equipment damage. Cautions will be shown in bold type.

NOTE offers helpful information concerning certain operating procedures. Notes will be shown in italics.

Equipment Identification

The unit's identification number (specification, model, serial number) usually appears on a nameplate attached to the front panel.

Receipt Of Equipment

When you receive the equipment, check it against the invoice to make sure it is complete and inspect the equipment for possible damage due to shipping. If there is any damage, notify the carrier immediately to file a claim. Furnish complete information concerning damage claims or shipping errors to the company shown on the cover of this manual. Include all equipment identification numbers and group part numbers (if any) as described above along with a full description of the parts in error.

Move the equipment to the site of installation before uncrating. Use care to avoid damaging the equipment when using bars, hammers, etc., to uncrate the unit.

Additional copies of this manual may be purchased by contacting the company shown on the cover of this manual. Include the Owner's Manual number and equipment identification numbers.

SAFETY INSTRUCTIONS AND WARNINGS

FOR OPERATION OF BATTERY CHARGING EQUIPMENT

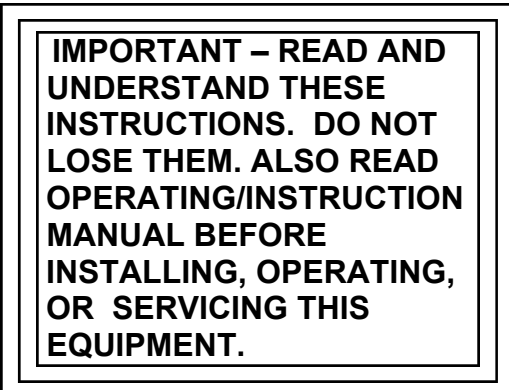

A. General

Battery charging products can cause serious injury or death, or damage to other equipment or property, if the operator does not strictly observe all safety rules and take precautionary actions.

Safe practices have developed from past experience in the use of charging equipment. These practices must be learned through study and training before using this equipment. Anyone not having extensive training in battery charging practices should be taught by experienced operators.

Only qualified personnel should install, use, or service this equipment.

B. Shock Prevention

Bare conductors, or terminals in the output circuit, or ungrounded, electrically-live equipment can fatally shock a person. To protect against shock, have competent electrician verify that the equipment is adequately grounded and learn what terminals and parts are electrically HOT.

The body's electrical resistance is decreased when wet, permitting dangerous current to flow through the body. Do not work in damp area without being extremely careful. Stand on dry rubber mat or dry wood and use insulating gloves when dampness or sweat cannot be avoided. Keep clothing dry.

1. Installation and Grounding of Electrically Powered Equipment – Electrical equipment must be installed and maintained in accordance with the National Electrical Code, NFPA 70, and local codes. A power disconnect switch must be located at the equipment. Check nameplate for voltage and phase requirements. If only 3-phase power is available, connect *single-phase* equipment to only two wires of the 3-phase line. **DO NOT CONNECT** the equipment grounding conductor (lead) to the third live wire of the 3-phase line as this makes the equipment frame electrically HOT, which can cause a fatal shock.

If a grounding lead (conductor) is part of the power supply cable, be sure to connect it to a properly grounded switch box or building ground. If not part of the supply cable, use a separate grounding lead (conductor). Do not remove a ground prong from any plug. Use correct mating receptacles. Check ground for electrical continuity before using equipment.

The grounding conductor must be of a size equal to or larger than the size recommended by Code or in this manual.

2. Charging Leads – Inspect leads often for damage to the insulation. Replace or repair cracked or worn leads immediately. Use leads having sufficient capacity to carry the operating current without overheating.
3. Battery Terminals – Do not touch battery terminals while equipment is operating.
4. Service and Maintenance – Shut OFF all power at the disconnect switch or line breaker *before* inspecting, adjusting, or servicing the equipment. Lock switch OPEN (or remove line fuses) so that the power cannot be turned ON accidentally. Disconnect power to equipment if it is to be left unattended or out of service.

Disconnect battery from charger.

Keep inside parts clean and dry. Dirt and/or moisture can cause insulation failure. This failure can result in high voltage at the charger output.

C. Burn and Bodily Injury Prevention

The battery produces very high currents when short circuited, and will burn the skin severely if in contact with any metal conductor that is carrying this current. Do not permit rings on fingers to come in contact with battery terminals or the cell connectors on top of the battery.

Battery acid is very corrosive. Always wear correct eye and body protection when near batteries.

D. Fire and Explosion Prevention

Batteries give off explosive flammable gases which easily ignite when coming in contact with an open flame or spark. Do not smoke, cause sparking, or use open flame near batteries. Charge batteries only in locations which are clean, dry, and well ventilated. Do not lay tools or anything that is metallic on top of any battery. All repairs to a battery must be made only by experienced and qualified personnel.

E. Arcing and Burning of Connector

To prevent arcing and burning of the connector contacts, be sure the charger is OFF before connecting or disconnecting the battery. (If the charger is equipped with an ammeter, the ammeter should not indicate current flow.) Always connect battery before turning charger ON.

F. Medical and First Aid Treatment

First aid facilities and a qualified first aid person should be available for each shift for immediate treatment of electrical shock victims.

EMERGENCY FIRST AID: Call physician and ambulance immediately. Use First Aid techniques recommended by the American Red Cross.

DANGER: ELECTRICAL SHOCK CAN BE FATAL. If person is unconscious and electric shock is suspected, do not touch person if he or she is in contact with charging leads, charging equipment, or other live electrical parts. Disconnect (open) power at wall switch and then use First Aid. Dry wood, wooden broom, and other insulating material can be used to move cables, if necessary, away from person. IF BREATHING IS DIFFICULT, give oxygen. IF NOT BREATHING, BEGIN ARTIFICIAL BREATHING, such as mouth-to-mouth. IF PULSE IS ABSENT, BEGIN ARTIFICIAL CIRCULATION, such as external heart massage.

IN CASE OF ACID IN THE EYES, flush very well with clean water and obtain professional medical attention immediately.

G. Equipment Warning Labels

Inspect all precautionary labels on the equipment. Order and replace all labels that cannot be easily read.

DESCRIPTION OF EQUIPMENT

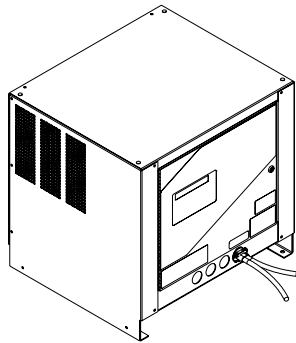

Figure 3-1

The basic charging circuit is the silicon controlled rectifier-type with isolating transformer (s). This SCR design regulates charging current by allowing the battery to determine its own charge cycle rate in accordance with its state of discharge. It provides a constant current-constant voltage-constant current (IEI) charge that eliminates the possibility of overcharging, even with line voltage variations of $\pm 10\%$ and allows the battery to finish at the proper current regardless of battery age or gravity type. Single-phase and three-phase input chargers have one transformer.

The Ultra Charge provides the optimum battery charging possible over a wide range of environmental conditions. The charger will precisely charge your battery based on battery temperature, type, and size; by automatically adjusting its own output charge characteristic within the power limits of the chargers power circuit.

When applied with the Prestolite optional Battery Identification Module (BID), the Ultra Charge identifies the battery at the time of connection and adjusts its output for that specific battery. During the charge cycle, the Ultra Charge continuously monitors the battery's temperature via the BID and adjusts its output to match the battery temperature as it changes throughout the charge cycle.

The BID module also allows for completely automatic operation of the chargers multi-voltage and multi-ampere-hour feature. Upon connection, the Ultra Charge reads the information programmed into the BID and identifies the battery's AH rating, cell size, type of construction, electrolyte temperature, and adjusts its output curve based on this information.

The Ultra Charge is internally protected against overload and short circuits by both input and output fusing, plus Prestolite's unique *curve monitoring circuit* periodically measures the output curve to ensure that the voltage and current are within the limits set at the factory.

Operating Modes

The Ultra Charge can be set to default to any one of three operating modes. The **Multi-Cell** mode allows the charger to automatically adjust its output to match the cell size of the battery. In **Fixed-Cell** mode, the charger will only charge the cell size programmed into the control and will reject batteries of other cell sizes.

With a Prestolite Battery Identification Module installed on your batteries, the Ultra Charge always defaults to the BID mode.. The charger automatically adjusts its output to match the battery information programmed into the module.

This feature allows users with various cell size batteries to charge any battery on any charger without the fear of mismatching batteries and chargers. In applications where daily charging is not necessary, one charger could be purchased to charge two different cell size batteries.

User Selectable Output Curves

As the technology of battery construction changes, so does the charging requirements of those batteries. The Ultra Charge is designed to meet those requirements through three user selectable output curves.

Several output curves are preprogrammed into the Ultra Charge and are easily selected by the user via the control keypad. The standard curve is for **flooded lead acid** batteries with the other curves designed for **sealed lead acid** batteries. Should a new battery technology arise, the Ultra Charge has an additional user programmable **custom curve**. This curve allows the user to customize the curve for new technologies, unusual application requirements, or simply to meet customer preference.

UC2000 Control

The extreme flexibility of the Ultra Charge lies in the state of the art micro controller used in the UC2000 charger control.

The UC2000 is made up of two main components: the Control /Regulator Board, and the Keypad/Display. The Control portion provides the basic operating features of the charger, such as auto start/stop, auto equalize, charge cycle review, real time clock, communications, etc. The Regulator portion actually controls the firing or switching of the SCRs, thus controlling the chargers DC output.

The Keypad/Display provides the user interface with the charger. The durable membrane keypad is impervious to moisture and mechanical shock. The bright 2 line 20 character alphanumeric vacuum florescent display constantly shows the charger's output volts, amps, and amp hours returned during the charge cycle. The display also provides the user with plain English messages concerning charge cycle status.

Four bright LEDs molded into the keypad keep the user informed of charge status at a glance, even from long distances. LEDs notify you that a charge is in progress, that the battery is 80% charged, equalize cycle, charge complete, and fault indication.

When charging lead acid batteries, with the same number of cells and ampere-hour capacity as shown on charger nameplate, the charging time will be approximately 8 hours. Batteries of smaller or larger ampere-hour capacities can also be charged, but will require shorter or longer charging, respectively.

WARNING: Do not connect a battery to this charger if any lamp is lit. Do not disconnect a battery from this charger while a charge is in progress. Otherwise, damage to charger, arcing and burning of connector parts or a battery explosion may result. Batteries produce explosive gases. Keep sparks, flame, and cigarettes away. Ventilate when charging in an enclosed area. Always shield eyes when working near batteries.

I-E-I Volt Amp Curve

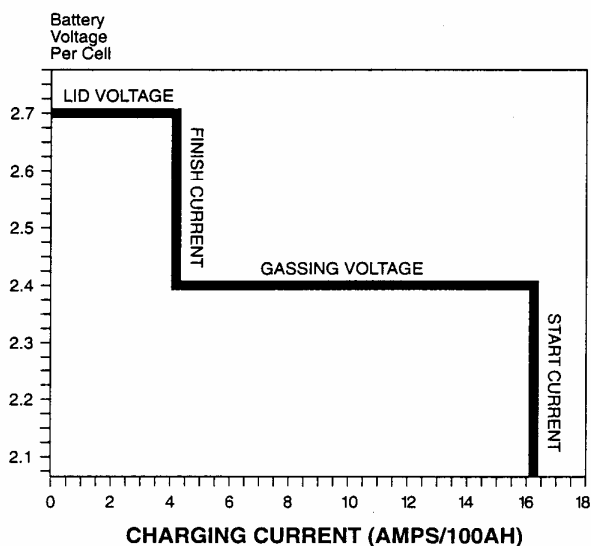

Typical I-E-I Recharge Curves

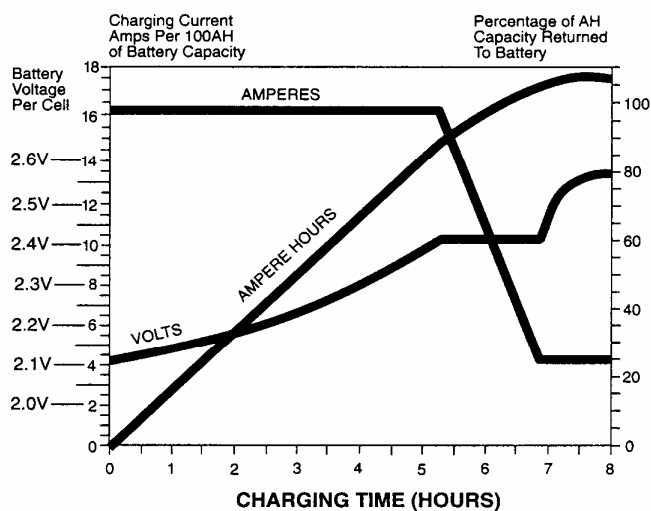

Figure 3-2

INSTALLATION

Location

For best operating characteristics and longest unit life, take care in selecting an installation site. Avoid locations exposed to high humidity, dust, high ambient temperature, or corrosive fumes. Moisture can condense on electrical components, causing corrosion or shorting of circuits (especially when dirt is also present).

Adequate air circulation is needed at all times in order to assure proper operation. Provide a minimum of 6 inches of free air space at rear and sides of the unit. Make sure that ventilation openings are not obstructed.

Always remove the charger shipping skid from the unit before installation. The charger must be installed over a noncombustible surface such as concrete or metal. Keep the charging area clear of all combustible material such as wood, paper, and cloth. When moving the charger after the packing skid and box have been removed, make sure that lifting forks do not damage the charger panels or cables.

WARNING: SPARKS OR MOLTEN METAL falling through open bottom can cause fire or explosion.

- Install over noncombustible material such as concrete or metal.
- Keep charging area clear of combustible material.

Environmental Characteristics

Operating Characteristics	0°C to 40°C (32°F to 104°F)
Operating Altitude	To 2000 Meters (6562 Feet)
Operating Humidity	80% up to 31°C, decreasing to 50% at 40°C, non-condensing 80% up to 88°F decreasing to 50% at 104°F, non-condensing

Grounding

The frame of the power source must be grounded for personnel safety. Where grounding is mandatory under state or local codes, it is the responsibility of the user to comply with all applicable rules and regulations. Where no state or local codes exist, it is recommended that the National Electrical Code be followed.

In addition to the usual function of protecting personnel against the hazard of electrical shock due to fault in the equipment, grounding serves to discharge the static electrical charges which tend to build up on the surfaces of equipment. These static charges can cause painful shock to personnel, and can lead to the erroneous conclusion that an electrical fault exists in the equipment.

If a charger is to be connected to the AC power supply with a flexible jacketed cable, one having a separate grounding conductor should be used. When included in cable assembly, grounding conductor will be green, green with a yellow stripe, or bare. When connecting input power to charger (as instructed in Line Connection to Battery Charger section of this manual), connect grounding conductor to equipment grounding terminal (stud with a green nut and a cup washer and identified by symbol \equiv), taking care to make a good electrical connection. Connect other end of grounding conductor to the system ground.

If, for any reason, an input cable which does not include a grounding conductor is used, the equipment must be grounded with separate conductor. Minimum size and color coding requirements must be in accordance with any applicable state or local code, or the National Electrical Code.

If metallic armored cable or conduit is used, the metal sheathing or conduit must be effectively grounded as required by state or local code, or the National Electrical Code.

If a system ground is not available, the charger frame must be connected to a driven ground rod (at least 8 ft [2438 mm] long), or to a water pipe that enters the ground not more than 10 ft (3048 mm) from the charger. A grounding conductor must be connected to the rod or pipe in a manner that will assure a permanent and effective ground. The conductor must be sized in accordance with any applicable state or local code, or by the National Electrical Code. If in doubt, use the same size conductor as is used for the conductors supplying power to the charger.

WARNING: ELECTRIC SHOCK HAZARD – Under no circumstance should you use a grounding conductor with a current carrying capacity less than the ampere rating shown in Table 4-1.

LINE AMPS	DISCONNECT SWITCH *	BRANCH FUSE SIZE (AMPERES)	COPPER CABLE SIZE AWG **	
			POWER	GROUND
0-2.5	30A	5	No. 14	No. 14
2.6-4.5	30A	7	No. 14	No. 14
4.6-7.5	30A	10	No. 14	No. 14
7.6-12	30A	15	No. 14	No. 14
12.1-16	30A	20	No. 12	No. 12
16.1-18	30A	25	No. 10	No. 10
18.1-22	30A	30	No. 10	No. 10
22.1-24.5	60A	35	No. 8	No. 10
24.6-32.5	60A	40	No. 8	No. 10
32.6-40	60A	50	No. 8	No. 10
40.1-45	60A	60	No. 6	No. 10
45.1-57.5	100A	80	No. 4	No. 8
57.6-78	100A	100	No. 2	No. 8
78.1-102.5	200A	125	No. 2	No. 6
102.6-135	200A	150	No. 1/0	No. 6

Table 4-1 Recommended AC Input and Branch Fusing

The above table (Table 4-1) is based on 75°C (167°F) rated conductors and 40°C (104°F) ambient temperatures. Refer to National Electrical Code (2008) Tables 310-16 corrected to 40°C (104°F).

* For 115, 208, and 230-volt lines, use 250-volt disconnect switch.
 For 440-480, 575-volt lines, use 600-volt disconnect switch.

** Two conductors and ground conductor required for single phase.
 Three conductors and ground conductor required for three phase.

Recommended minimum size of grounding conductors (based on National Electrical Code 2008 – Table 250-95).

Line Voltage Changeover Instructions

1. Determine if the charger is connected for available line voltage. A label located near AC input terminals is marked with the AC voltage for which the charger is factory connected.
2. If charger is not connected correctly, check serial nameplate to determine that charger is equipped to be connected for available line voltage. If charger is suitably equipped, make voltage changeover connections by following instructions on AC input label inside charger.
3. If charger is reconnected, check input fuse (s) ratings with ratings specified on label and replace if necessary.

CAUTION: INCORRECT CONNECTIONS AND INCORRECT FUSE SIZE can damage this equipment. Follow voltage changeover instructions carefully.

Line Connections to Battery Charger

Follow local code requirements if different than instructions in this manual.

1. Turn charger OFF.
2. Be sure charger is connected correctly for available line voltage as instructed above.
3. On charger nameplate, note the AC input amperes corresponding to the line voltage to which charger is to be connected. Use that ampere value to select the proper disconnect switch, fuse, and power cable sizes from Table 4-1. A "WARNING" label inside charger also lists fuse sizes for each line voltage (circled fuse rating is required for internal line voltage connections made at factory).
4. Route AC power input cable in through knockout provided in side panel of charger cabinet. Securely fasten cable wires to a power input terminal inside charger. Refer to Grounding section of this manual for proper connection of grounding conductor. (Charger cabinet top or side panel, or both, may have to be removed to provide access to terminal block.)

5. With disconnect switch (on AC input power line) in "OPEN" or "OFF" position, connect power cable coming from charger, to the switch. Install fuses in switch.

Charging Cable Connectors

If connectors are already attached to charging cables, make sure that they are attached so that positive charger polarity will connect to positive battery terminal.

If connectors must be attached to charging cables, follow instructions supplied with connectors.

CAUTION: Make sure connectors are securely attached to cables (good solder joint or well tightened set screws, whichever is applicable). Be certain that positive charger cable will connect to positive battery terminal. If necessary, trace cables into charger and use supplied connection diagram to determine polarity. The use of a DC voltmeter may show polarity. Improper connections will "blow" output fuse and may cause other damage.

Note: If this charger is equipped with certain optional features, the connector attaching procedure may be modified. Refer to OPTIONS chapter of this manual for details.

Pre-operation Checks

1. Inspect charger thoroughly for damage; loose screws, nuts, or electrical connections.

WARNING: ELECTRICAL SHOCK HAZARD – Before inspecting or cleaning inside cabinet, turn OFF and remove fuses of disconnect switch (supplying AC power to charger) and disconnect battery.

2. Remove all special tags that are tied to charger. Keep tags with this manual for future reference. Leave all precautionary and instruction labels in place on charger. Carefully read and follow instructions on all tags and labels. Make sure all labels remain visible to anyone operating charger.
3. Make sure all charger cabinet panels are fastened in place, to assure proper flow of ventilating air through cabinet.

Pre-Operation Changes To The Factory Control Settings

Typically few changes are required to be made if the amp hour rating is sized to the battery and the voltage rating is equal to or greater than the battery. However, in some applications, some changes to the programmable control settings may be desirable. The most common changes are listed below:

TIME Factory Setting for Time is Eastern Standard. (see Programming the UC2000).

MAX BATTERY TEMPERATURE Factory Setting is 150° F (see Programming the UC2000).

NOTE: It is advisable to check the day of the week, date, month, and year for accuracy

AUTO EQUALIZE Factory setting is ON (see Programming the UC2000).

AUTO EQUALIZE TYPE Factory setting is by Cycle (see Programming the UC2000).

AUTO EQUALIZE COUNT Factory setting is 05 (see Programming the UC2000).

MULTI-CELL MODE Factory setting is ON. Can be changed if the user wants the charger to reject all batteries of a different cell size than the cell size programmed into the Fixed Cell Size function (see Programming the UC2000).

FIXED-CELL SIZE Factory setting is the maximum rating of the charger (example 750T3-24, would default to 24 cells). It can be changed if the user wants the charger to reject all but a single cell size battery when operating with the Multi-Cell Mode OFF (see Programming the UC2000).

Other functions are available for programming the UC2000 to meet your specific charging needs. Programming these functions is described in the Programming Your UC2000 chapter of this manual.

MAINTENANCE

WARNING: ELECTRICAL SHOCK HAZARD — Before inspecting or cleaning inside cabinet, turn OFF and remove fuses of disconnect switch (supplying AC power to charger) and disconnect battery.

Inspection And Cleaning

For uninterrupted, satisfactory service from this charger, it's necessary to keep unit clean, dry, and well ventilated. At least every three months, or more often as necessary, wipe and blow out all dirt from unit's interior components, with clean, dry air of not over 25 psi (172 kPa) pressure. Use a hand bellows if compressed air isn't available.

Check and tighten all electrical connections as necessary to eliminate unnecessary losses and to avoid subsequent trouble from overheating or open circuits. Check for broken wiring or damaged insulation on wiring.

WARNING: ELECTRICAL SHOCK HAZARD — Failure to keep internal parts clean and dry may allow transformer (s) to short out, causing secondary circuits to carry dangerously high voltage.

Be sure to replace all charger cabinet panels after any servicing, to assure proper flow of cooling air through unit and to protect internal components.

WARNING: ELECTRICAL SHOCK HAZARD — All cabinet panels must be replaced to protect personnel from contact with hazardous voltages.

Lubrication

None required.

Fuse Replacement

The SCRs and silicon diodes in this charger are protected by a "fast-clearing" type fuse.

CAUTION: The use of any other type fuse besides the "fast-clearing" type may cause damage to silicon diodes.

OPERATION

The operating procedure given here explains the operation of a Prestolite Ultra Charge equipped with the Prestolite UC2000 Control.

NOTE: If this charger is equipped with certain optional features, the operating procedure may be modified. Refer to Options chapter of this manual for details. Options not covered in this chapter will be described on separate "addendum" sheets enclosed with the manual.

Preliminary

1. Make sure that charger is installed and grounded as instructed in this manual.
2. Turn on main fused disconnect switch that supplies AC power to charger.
3. Maintain electrolyte level in batteries to be charged, as instructed by battery manufacturer. The volume of electrolyte will expand during the charge. Therefore, to avoid overfilling, do not add water until the battery has received at least an 80% charge. This will usually be reached at the time gassing starts.

Normal or Daily Charge

(For batteries with ampere-hour capacity within the range shown on charger nameplate)

1. Insure that battery size matches the charger and/or charger setting. (Number of cells is equal to or less than the charger nameplate rating and ampere-hour capacity is within charger nameplate rating.)
2. Securely engage the battery and charger connectors.
3. The charger will display READING BID and update the progress bar. (2 to 7 seconds) as the data is read into the charger.
4. After a short delay, the charger will turn on and the "Charge in Progress" LED will light. The alphanumeric display will indicate the cell size, amp hour and phase settings for the upcoming charge cycle. Then it will display current charging cycle information. "Verifying Battery" may appear for several minutes if the multi-cell mode is on.
5. The "80% Charged" LED will light when the battery has reached the gassing point.

6. When the charge termination point is reached, the charger will turn off and the "Charge Complete" LED will be lit. If an equalize charge has been selected, the "Equalize" LED will be lit.

NOTE: To disconnect battery from charger before charge is complete, press the red "Stop" key on the charger control panel.

NOTE: While not normally required, the charging rate may be adjusted to compensate for unusual ambient temperature, age of battery, etc. Refer to items 33 through 42 in Programming Your UC2000 chapter of this manual.

WARNING: EXPLOSION HAZARD
- Do not connect or disconnect a battery unless the "Charge in Progress" LED is off; otherwise, damage to charger, arcing and burning of connector parts or a battery explosion may result (batteries produce explosive gases). Keep sparks, flame, and cigarettes away. Ventilate when charging in an enclosed area. Always shield eyes when working near batteries. Disconnect battery if charger is to be turned off for prolonged periods of time.

NOTE: To disconnect battery from charger before charge is complete, press the red "Stop" key on the charger control panel.

Equalize or Weekend Charge

Batteries may need periodic equalizing to correct for inequalities between cells that result from daily or frequent cycling. An equalizing charge should be given if any of the following conditions exist:

1. The specific gravity of any cell at the end of charge is 20 points less than the average.
2. The on-charge voltage of any cell at the end of charge is 20 MV less than the average.
3. The battery has been stored for 30 days.
4. A large volume of water has been added.

When the equalize mode is desired, follow the operation outlined for a normal charge and press UC2000 "Equalize" key to set the charge control for an Additional 3 hours more than required for a normal charge. The charge is complete when charge control automatically lights the "Charge Complete" LED.

NOTE: The UC2000 is shipped from the factory set to the Auto Equalize by Cycle mode, and will automatically provide an equalize charge every 5 complete cycles.

Manual Stop

To stop any charge cycle before charge complete, press the red "Stop" key. For maximum shift run times and longest battery life, the charger should be allowed to always reach charge complete.

WARNING: Do not connect a battery to this charger if any lamp is lit. Do not disconnect a battery from this charger while a charge is in progress. Otherwise, damage to charger, arcing and burning of connector parts or a battery explosion may result. Batteries produce explosive gases. Keep sparks, flame, and cigarettes away. Ventilate when charging in an enclosed area. Always shield eyes when working near batteries.

AC Power Fail

The UC2000 Control will resume the charge where it left off when the AC power failure occurred, virtually unaffected charge time.

As power is returned, if a charge cycle was in progress, the display may show "ACFAIL RESTART". The charger is staggering the restart based on cycle run times. This will prevent multiple chargers from restarting all at once, minimizing peak restart power.

NOTE: If a battery is disconnected from the charger during an AC power failure and discharged, reconnecting it or any other battery may result in an incomplete charge cycle.

WARNING: ELECTRICAL SHOCK HAZARD – Before checking electrical components, turn off and remove fuses or disconnect switch (supplying AC power to charger) and disconnect battery.

Abnormal Shutdowns

1. Manual Stop
If the manual stop key is pressed during the charge cycle, the charger will shutdown. All 4 LEDs will be flashing and the display will read "Manual Stop Fault".
2. Back-Up Timer Shutdown
The standard UC2000 Control has two back-up timers. The charger will shutdown and "Backup timer" will be displayed if 9 hours has passed since the start of a charge cycle and the battery has not reached gassing voltage (80% charged), or if 4 hours has passed since the battery has reached gassing voltage and a DV/DT charge termination has not occurred. If the DV/DT feature has been disabled (see Voltage Time section), only the nine-hour back-up timer is active.
3. Battery Disconnect Shutdown
If a battery is disconnected from the charger during a charge cycle, the charger will be shut down. All LEDs will be off.

- | | |
|--|---|
| <p>4. Low Current Shutdown
If the charger output falls below a predetermined level, a low current shutdown will occur. All 4 LEDs will be flashing and the display will read "Low Current Fault".</p> <p>5. Curve Error Shutdown
If the charger output becomes uncontrolled and falls above or below the proper level for predetermined period of time, the charger will shutdown. All 4 LEDs will flashing and the display will read "Curve Error Fault".</p> <p>6. Unbalance Input Current Shutdown
If the charger input current becomes unbalanced for a predetermined period of time, the charger will shutdown. All 4 LEDs will be flashing and the display will read "Unbalanced Line Fault".</p> <p>7. Didt Shutdown
After the 80% charged point, if the output current begins to rise for more than a predetermined time period, the charger will be shutdown. All 4 LEDs will be flashing and the display will read "Didt Fault".</p> <p>8. Low Voltage Shutdown
If a battery on charge does not reach a minimum on charge voltage in a predetermined period of time, the charger will be shutdown. All 4 LEDs will be flashing and the display will read "Low Voltage Fault".</p> | <p>9. High Amp Hour Returned Shutdown
If the cycle amp hours returned exceed the BID AH setting or charger maximum AH rating for a predetermined amount, the charger will shutdown. All 4 LEDs will be flashing and the display will read "High Amp Hour Fault".</p> <p>10. Bad BID Read Shutdown
After 30 minutes have passed into a charge cycle, a BID reading will take place, if the presence on a BID is detected where one was not at battery connect, the charger will shutdown. All 4 LEDs will be flashing and the display will read "Bad BID Fault".</p> <p>Charger Input Phase Setting</p> <p>The charger control must be set to match input phase of the charger. All units received from the factory will have this item preset. To toggle the control setting, press and hold either the 1 (1 phase) or 3 (3 phase) front panel key for 3 seconds at AC power up.</p> |
|--|---|

ULTRA CHARGE RECHARGING CAPABILITY

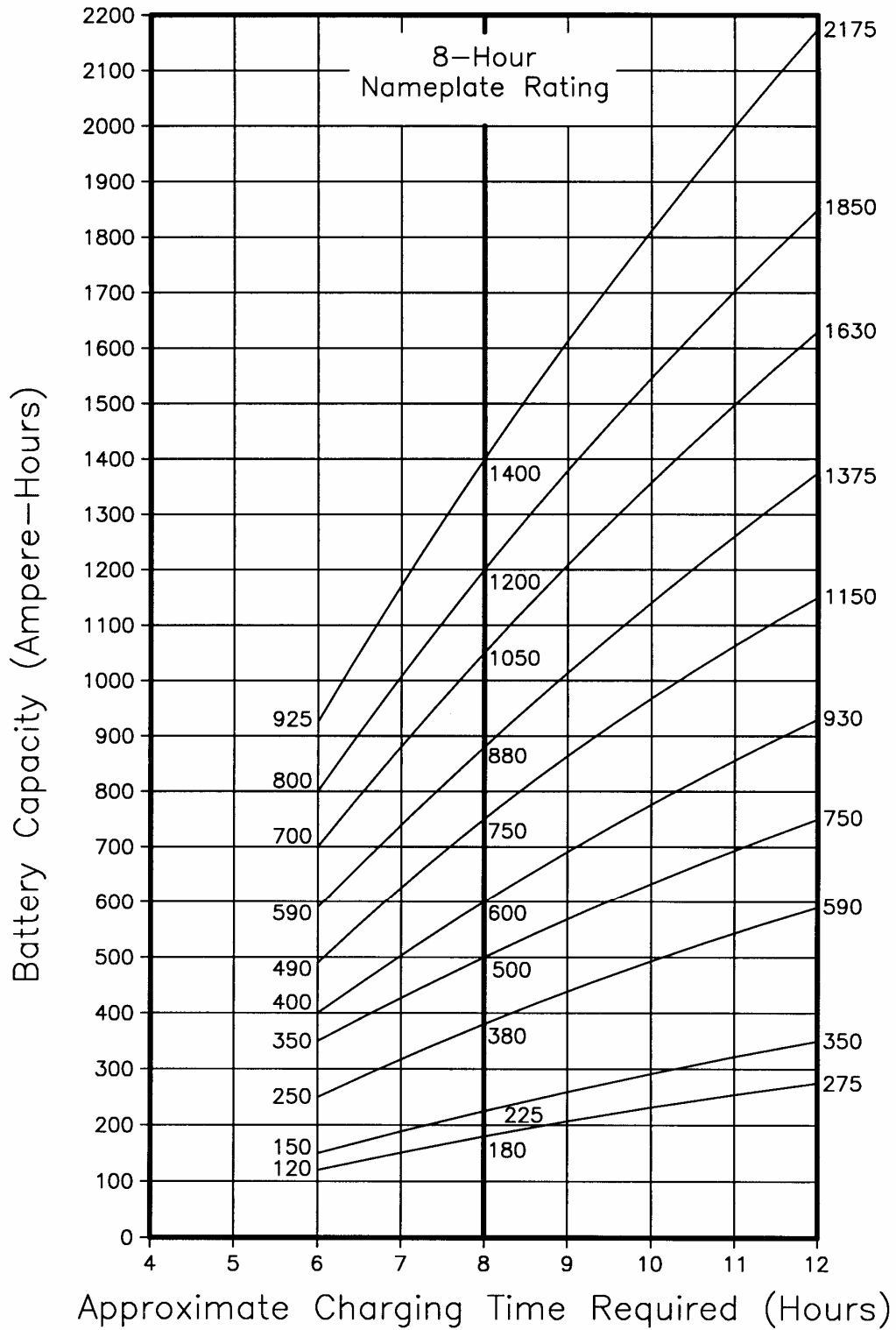

Figure 6-1

UC2000 CONTROL FEATURES

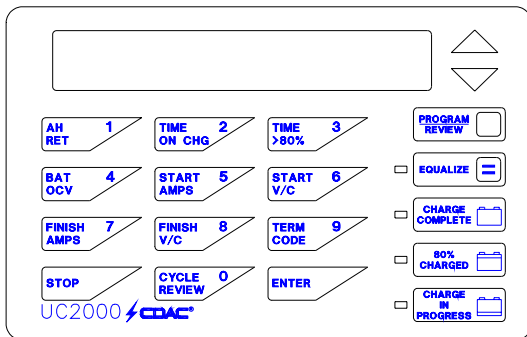

Figure 7-1

Main Features

1. 16.3 A/100AH charging output rate.
2. Multi-Voltage Charging Capability
3. Multi-Ampere-Hour Charging Capability
4. Automatic or Manual Battery Temperature Compensation
5. 15 Minute Minimum DV/DT Charge Termination
6. 2x20 Character Alphanumeric Display
7. Four LEDs for Status Display
8. LED lamp test provided on start up
9. Manual Stop Capability
10. One touch Review of Charge Cycle Information during charge cycle or after charge complete
 - Amp hours returned during charge cycle
 - Total time on charge
 - 80% point to end of charge timer
 - Battery open circuit voltage
 - Start current
 - Start voltage (volts/cell)
 - Finish current
 - Finish voltage (volts/cell)
 - Charge termination code
11. Review of Charge Cycle Data and Programmed Features
12. Review of Archived Charge Cycle Data for the Last 99 Charge cycles.
 - Amp hours returned during charge cycle
 - Total time on charge
 - 80% point to end of charge timer
 - Battery open circuit voltage*
 - Start current
 - Start voltage (volts/cell)
 - Finish current
 - Finish voltage (volts/cell)
 - Charge termination code
 - Equalize time
 - Start time
 - End time
 - Battery I.D.
 - Battery I.D. start temperature
 - Battery I.D. end temperature
 - Cycle ampere-hours
 - Cycle cell size
 - Battery Type*
 - Month
 - Date

* NOT INCLUDED ON DATAMATE REPORT
13. Automatic or Push-to-Start Operation
14. Manual or Automatic Equalize Operation
15. Fault Lock-out or No Fault Lock-out Operation
16. Back-up Timer Shutdowns
17. Failure Mode Diagnostics
 - High Battery Reject
 - Low Battery Reject
 - Battery Reject
 - Battery Over-temperature
 - Setup Error
 - Low Voltage S.D.
 - Charge Curve Error
 - Low Current S.D.
 - Backup Timer
 - Manual Stop
 - Fault Lockout
 - Over Maximum Amp Hour Returned S.D.
 - Unbalanced Line S.D.
 - DIDT S.D.
 - BID Read Error

18. One Part Number Control is User/Factory programmable for 6-9-12-18-24 Cells and 100-200-400 Amp Digital Ammeter
- Note: Units that include 36 and 40 cells require an additional part number.*
19. Adjustable 8-99 Hour Refresh Charge Delay
20. Voltage Time Feature (DV/DT Disable)
21. "Cell Forming" Feature (Programmable from 0-30 Cycles)
22. Programmed Features and Archive Data maintained for a minimum of 10 Years
23. Charge Cycle Data and Time-of-Day/Date maintained for a minimum of 10 Years
24. 6 Programmable Start Modes
- Automatic Start (5 Second Delay)
 - Push-To-Start
 - Delayed Start
 - Time-of-Day Start
 - Time-of-Day Blockout
 - Timer Mode
25. Programmable Manual Override of Start Modes
26. User Programmable Password
27. Automatic Equalize By Number of Charger or BID Cycles, Day of Week
28. Programmable Cool Down Time
29. Staggered Start on ACFAIL Recovery

Description of Features

Multi-Voltage Charging — The Ultra Charge with UC2000 Control provides the capability to charge batteries of different cell sizes. With the Multi-Cell Mode ON, the charger automatically selects the proper output voltage. A 24 cell Ultra Charge will safely charge 24, 18, 12, 9, and 6 cell batteries. An 18 cell Ultra Charge will safely charge 18, 12, 9, and 6 cell batteries. A 12 cell Ultra Charge will safely charge 12, 9, and 6 cell batteries.

Fixed mode operation can be selected by programming Multi-Cell mode to OFF. In this mode the charger will charge only batteries of the cell size programmed into the Fixed-Cell size function.

If the battery is equipped with Prestolite BID Module, the Multi-Cell ON or OFF function will be overridden and the charger will charge the battery if it is within the charger output rating.

Multi-Ampere-Hour Charging — The Ultra Charge with UC2000 Control provides the capability of charging batteries of different cell sizes at the proper charge rates. Fixed Mode can be selected by programming an amp hour rating into the Fixed AH size function that is less than the charger ampere-hour nameplate rating. The output current will be adjusted to deliver current at the proper rate. Attempts to program ampere-hour sizes larger than the nameplate rating will not be accepted by the control.

If the battery is equipped with a Prestolite BID Module, the Fixed Ampere-Hour function will be overridden and the charger will charge the battery at the rate programmed into the BID Module (BID Module programming is performed at the factory based on information provided by the customer) if it is within the charger output rating. If the BID and battery ampere-hour rating are greater than the charger rating, the charger will charge the battery at the nameplate amp hour rating.

Multi-AH Programming Feature – The Multi-AH Programming Feature allows the control to be programmed to charge different voltage batteries with the AH rates and curve types that have been programmed for that battery voltage. When a battery is connected, the control automatically senses the battery voltage and sets the charge curve and charging rates to the level that has been programmed.

If the battery is equipped with a Prestolite BID Module, the Fixed Ampere-Hour function and Multi-AH Programming will be overridden and the charger will charge the battery at the rate programmed into the BID Module (BID Module programming is performed at the factory based on information provided by the customer) if it is within the charger output rating. If the BID and battery ampere-hour rating are greater than the charger rating, the charger will charge the battery at the nameplate amp hour rating.

Temperature Compensation — The Ultra Charge with UC2000 Control is capable of modifying the output voltage to compensate for ranges of battery electrolyte temperatures from 32 to 132 degrees F. Because the 80% percent point is based on reaching a point on the charge curve rather than a single voltage, it is automatically adjusted with the output voltage.

CAUTION: Consult your batteries manufacturer for the recommended maximum battery temperature for your battery.

When the battery is equipped with a Prestolite BID module, the charger automatically reads the battery temperature throughout the charge cycle and adjusts the output voltage to match the battery temperature.

Manual adjustment of the charger output voltage to match the temperature of the battery is performed by programming the proper battery electrolyte temperature into the Fixed Battery Temperature function (BID readings automatically override the Fixed Battery Temperature setting).

Max Battery Temperature—The UC2000 monitors the battery temperature throughout the charge cycle. Programming the MAX BATT TEMP setting of the control to the desired maximum battery temperature will cause the charger to shut down if the battery on charge is equipped with a BID and the temperature exceeds the set point. It will wait until the battery temperature has decreased to 5 degrees C below the set point before restarting the charge cycle.

Charge Termination — The UC2000 utilizes a patented proportional time DV/DT technique in order to determine the charge termination point. This technique returns approximately 107% of the amp hours removed from a battery (regardless of the state of discharge) and prevents variations in the incoming AC line voltage from affecting the amount of Energy returned to the battery. The minimum time required for a DV/DT charge termination on the UC2000 Control is fifteen minutes. The UC2000 Control can be programmed to utilize a voltage-time charge termination technique. If the DV/DT charge termination is disabled, the control will terminate the charge cycle four hours after the battery reaches the “80% Charged” point.

Alphanumeric Display — A vacuum florescent dot matrix 2x20 character display is standard on the UC2000 Control. The characters are .35 inches tall, making the information on the digital display legible at distances exceeding ten feet. Plain English and easy to understand abbreviations are used to indicate charge status output current and voltage and other functions including; archive information, review information, programming information, fault information, and operating status. A blank display is utilized for AC power fail indication.

Status Display LEDs — The “Charge In Progress” LED (Amber) is illuminated whenever the charger is flowing current to the battery. There are four status LEDs provided to indicate the present operating status of the charger and battery (see Figure 6-1). A lamp test feature is provided. See [Review of Charge Cycle](#) feature.

Review of Charge Cycle — When the charge cycle is in progress or has been terminated, either by the UC2000 Control or the operator, the charge cycle history can be automatically read out by pressing the “Cycle Review” key. After displaying the information from memory, the unit will return to the normal (Ultra Charge) display.

All status LEDs will be illuminated during the review of function number one, thus providing a lamp test feature. Nine functions are displayed during a standard review. If the charger is idle, the information in all 58 review functions can be displayed. See the [UC2000 Charge Cycle Review Feature](#) section in this chapter. A single item can be selected by pressing the appropriate labeled key. This feature can greatly aid in the analysis of charge data and in situations where troubleshooting is required. See the [Troubleshooting](#) chapter in this manual.

Automatic or Push-to-Start Operation — In the automatic start mode, the charger will start 5-15 seconds after the battery is connected. The alphanumeric display will display “READING BID” and then display upcoming cycle information. In the push-to-start mode, the charger will not start the charge cycle until the “Enter” key is pressed. “Ent to Start Charge” will be displayed on battery connect when this feature has been selected.

Manual or Automatic Equalize — An equalize charge is a prolonged charge cycle (by 3 hours) used to correct any inequalities of voltage and specific gravity which may have developed between the cells during service. UC2000 Controls are shipped from the factory with the automatic equalize feature enabled. This mode of operation is indicated in the full Review “AUTO EQ. ON” function. There are three modes of automatic equalize. See the [Automatic Equalize](#) section in this chapter for further details. When the automatic equalize feature is active, the “Equalize” key on the front panel is disabled. When automatic equalize is disabled, an equalize charge is requested by pressing the “Equalize” key on the front panel of the UC2000 Control during countdown or after the charge cycle has started. If this key is pressed again during the charge cycle, the equalize request will be canceled if the equalize period has not begun.

Fault Lockout Operation — In the normal operating mode (No fault lock-out), if an abnormal shutdown occurs, disconnecting and reconnecting the battery will clear the fault and the UC2000 will restart the charge cycle as programmed. If an abnormal shutdown occurs with the fault lock-out feature enabled, disconnecting and reconnecting a battery will not clear the fault condition. The alphanumeric display will display fault lockout, and the status LEDs will continue to flash even with no battery connected to the charger until the fault condition is cleared. The “Enter” key will clear the fault if it is pressed while a battery is not connected to the charger.

One Part Number Control — The standard UC2000 Control is user/factory programmable for 6, 9, 12, 18, and 24 cell Ultra Charges with 100, 200, and 400 amp shunts. Any combination of the above cell sizes and current shunt sizes can be selected by DIP switches on the P.C. board. This feature reduces the quantity of spare parts inventory. See Figure 8-1 for further information.

Refresh Charge Feature — A refresh charge of a storage battery is a charge given to charged and wet batteries which are in storage or inactive periods to replace losses due to local action and to insure that every cell is brought periodically to a full state of charge. The UC2000 Control has an adjustable 8 to 99 hour refresh charge timer (programmed through the "Refresh Delay" function) which starts with a normal charge complete, either DV/DT or voltage time. If a battery is left connected to the charger for the Programmed number of hours after a charge complete, the control will automatically begin a refresh charge cycle. The control will start automatically even if programmed for time-of-day start, delayed start or push-to-start operation. The UC2000 will not start the charge cycle during a time-of-day blackout period. It will automatically request an equalize cycle if it is programmed to equalize on that day. Charge cycle data (Functions #1-50) is not affected by a refresh charge. The charge termination technique for a refresh charge will be DV/DT regardless of how the control is user programmed, and the 0-80% back-up timer will be four hours and fifteen minutes during a refresh charge. This feature will insure that any battery left connected to the charger for extended periods of time will not be damaged due to self-discharge, and will be kept in a fully charged state.

Finish Cell Forming Feature — The UC2000 Control can be programmed to provide voltage-time charge termination and disable the low current shutdown feature for a limited number of charge cycles.

The number of cycles programmed into the Forming Cycles function will be forming cycles and that number will be decremented each time a charge complete condition is reached. The number of forming cycles selected can be from 0 to 30 charge cycles.

Input Kilowatt Hour Feature — The Control will calculate the *approximate* input kilowatt hour usage for each charge cycle. This feature may be helpful in determining the cost of charging given various charging scenarios with known electricity costs.

WARNING: Enabling the Finish Cell Forming feature will cause the charger to continue to run for a period of time if the battery has been disconnected before Charge Complete or pressing the Manual Stop key. This condition will continue until the programmed number of cycles have been completed. The battery should never be disconnected while a charge is in progress.

80% Charged Point — A standard UC2000 Control will light the "80% Charged" LED and enable the charge termination routine when the battery voltage reaches the gassing voltage and the charging has decreased below start current. The gassing voltage is nominally 2.40 volts/cell and is adjusted automatically when the charger output voltage is modified to charge batteries of different temperatures.

Data Retention — The UC2000 Control uses 2 types of electronic memory for data retention. Real time clock data is kept current by a non user replaceable lithium battery in the absence of AC power. All other program memory and charge cycle information is resident in non-volatile flash memory. The minimum data retention time should be at least 10 years.

Time-of-Day Start — The UC2000 Control can be programmed to delay the start of a charge cycle until a specific time of day. Any time of day, in one minute increments, can be used for the time-of-day start time.

When a UC2000 is programmed for time-of-day start, and a battery is connected to the charger, the programmed start time will be displayed. This feature can be used to save on energy costs, provide a battery cool down period, or to prevent opportunity charging.

Delayed Start — The UC2000 Control can be programmed to delay the start of a charge cycle for a specific period of time. Any time period from 1 minute to 23 hours and 59 minutes, in one minute increments, can be used for the delayed start period. When a UC2000 is programmed for delayed start, and a battery is connected to the charger, the programmed delay time will be displayed.

The time displayed will be decremented once per minute so that the time displayed is always the amount of time remaining before the start of charge. This feature can be used to save on energy costs, provide a battery cool down period, or to prevent opportunity charging.

Time-of-Day Blockout — The UC2000 Control can be programmed to disable the charger during a specific time of day. The charger will turn off at the beginning of the blockout period, and resume the charge cycle at the end of the blockout period. Any period of time of day, in one minute increments, can be used for the time-of-day blockout period. When a UC2000 is programmed for time-of-day blockout, and a battery is being charged when the blockout period occurs, the programmed end of blockout time will be displayed. This feature can be used to save on energy costs, provide a battery cool down period, or to prevent opportunity charging.

Manual Override of Programmed Start Modes — A UC2000 Control, when programmed for time-of-day start, delayed start, or time-of-day blockout, can be manually overridden by pressing the “Enter” pushbutton while the start of the charge cycle is being automatically delayed by the control. This manual override feature can be disabled through the “Start Override” programming function. The manual override feature allows the operator to start a charge cycle immediately if a battery is needed sooner than the programmed start time would allow.

Automatic Equalize — The UC2000 Control can be programmed for 3 different types of automatic equalize. UC2000 Controls are shipped from the factory programmed to automatically provide an equalize charge to every fifth complete charger cycle. The number of cycles between equalize requests can be varied from 0 to 30. If the UC2000 is programmed to automatically provide an equalize cycle every zero cycles, then an equalize charge cannot be requested manually and will never be provided automatically. The second type of automatic equalize mode is when an equalize charge is desired on a particular day of the week. When programmed for automatic equalize by day of week, the UC2000 will provide an equalize charge to any battery which is connected to the charger on the programmed equalize day. Additionally, any battery which is connected the charger previous to the day of week equalize day will be given an equalize charge provided that it is at a charge complete status when the UC2000’s clock calendar switches to the equalize day. The automatic equalize features allow for the consistent application of equalize charges without constant attention by the operators. The third type of equalize is by BID count. When programmed for this mode, the current complete cycle count is read from the BID at connect and compared to that of the equalize cycle counter. An equalize will be requested when the BID count equals the equalize cycle count programmed into function 22.

For further information on programming and reviewing the UC2000 features, refer to the Programming Your UC2000 chapter and the Reviewing UC2000 Charge Data section of this chapter.

Programmable Cool Down Time — A programmable cool down feature allows the battery to cool down for 0 to 8 hours before the charger signals charge complete. During the cool down period the alphanumeric display reads “Cool Down”. This feature allows the battery to cool down before being returned to use and can be used to minimize the battery maximum temperature during operation.

Maximum Battery Temperature — The UC2000 Control can be programmed to interrupt the charge cycle if the battery temperature exceeds the limit programmed into function. The temperature may be programmed from 80°F to 150°F. Once the battery cools down past the trip temperature the charge cycle will be resumed. The display will show “Battery Cooling” if the charge has been interrupted and the cooling period is taking place. A BID must be in use to utilize this function.

Start Gassing—A programmable time that effects how long from the start of a charge cycle before the gassing portion can begin. If the battery on charge reaches the finish portion of the curve and the gassing time has not elapsed, the charger current will shutoff and display “No Gassing”. This minimizes any battery gassing that may occur. Once the start gassing time is past, the charger will restart at the standard finish current and complete the charge cycle.

User Programmable Password — You may enter a custom 4 number password for use in keeping programming functions protected. When the feature is enabled (function 55), you will be prompted to enter the password. After that, anytime the user tries to access the programming menu, they will be prompted for this password.

UC2000 Charge Archive Function

The archive function allows up to 21 items of charge cycle information to be retrieved and displayed. The last 99 charge cycles are stored, with the most recent cycle labeled #1 and earlier cycles labeled in ascending order.

The most recent charger cycle data is moved to the #1 archive location when the next battery to be charged is connected to the charger. At this time the all previous archive cycle data is shifted to the next highest archive location (1 to 2, 2 to 3, etc.).

The following key sequence is used to access charge cycle archive data:

Keys	Display
PROGRAM/REVIEW	Enter → 1-REV 2-PROG Function 3-MAH 4-ARCH
4	Enter Arch Func # → 01 01-99/00 to Download
Key in the charge cycle number and press enter.	

The charge cycle data will automatically scroll through the display along with the charge cycle number. The 19 archive data items are described in detail below (see Figure 7-2).

AMP HOURS RET	The total ampere-hours returned during the charge cycle. This number includes ampere-hours delivered to the battery during the Verify, 0-80%, 80% to End, and Equalize portions of the charge cycle.
CHARGE TIME	The total charging time of the charge cycle. This number includes the time of the Verify, 0-80%, 80% to End, and Equalize portions of the charge cycle.
80% TO END	The time the battery was charged from the 80% charged point until DV/DT or VT (depending on the control setting) charge termination. This time does not include any equalize charging time that may have been automatically or manually selected.
BATTERY OCV	The open circuit voltage of the battery immediately before the beginning of the charge cycle.
START AMPS	The value of the current delivered to the battery at the start of the charge cycle.
START VOLTS	The value of the battery voltage (in volts/cell) of the battery at the start of the charge cycle.
FINISH AMPS	The value of the charge current delivered to the battery at the end of the charge cycle.
FINISH VOLTS	The value of the battery voltage at the end of the charge cycle.

TERM	The reason for charge cycle termination. All possible codes are listed below:
1-Charge Comp	Normal Charge Complete
2-Low Current	Low Current Error shutdown
3-Manual Stop	Manual stop
4-Battery Dis	Battery disconnected while charging
5-<80 Backup	0-80% Back-up Timer Error shutdown.
7-Cooling Int	CDAC function
8-CDAC Rej	CDAC Battery Rejection
9-Curve Error	Charger Output Curve Error shutdown
11-Unbal Line	Unbalanced Input Line Error shutdown
12-Didt	Rising Current/Falling Voltage Error shutdown
13-Lvsd	Low Charging Voltage Error shutdown
14-Ahsd	Excessive AH Returned Error shutdown
15-BID Read	BID Error Shutdown
EQUALIZE TIME	The time of the equalize portion of the charge cycle. Equalize can be automatically or manually selected.
START TIME	The time at the start of the charge cycle (Military format).
END TIME	The time at the end of the charge cycle. Includes the equalize time if it was automatically or manually selected (am/pm format).
BATTERY I.D.	The Battery I.D. number of the battery that was charged in the charge cycle. Requires Prestolite Battery Identification Module (BID).

BID START TEMP	The temperature of the battery sensed by the Prestolite Battery Identification Module at the start of the charge cycle.
BID END TEMP	The temperature of the battery sensed by the Prestolite Battery Identification Module at the end of the charge cycle.
CYC. AMP HOURS	The Ampere-hour setting of the charger during the charge cycle. This value cannot exceed the maximum charger output rating.
CYCLE CELLS	The Cell Size setting of the charger during the charge cycle. This value cannot exceed the maximum charger output rating.
BATTERY TYPE	The Battery Type setting of the charger during the charge cycle. This value cannot exceed the maximum charger output rating.
PRESENT MONTH	The month that the charge cycle occurred.
PRESENT DATE	The day of the month that the charge cycle occurred.

UC2000 Charge Cycle Review Function

The review function allows up to 58 (59 for 36 & 40 cell assemblies) items of charge cycle information to be retrieved and displayed. Only the last charge cycle is stored, with the data being moved into archive cycle #1 location when the next battery is connected to the charger. The review data functions described in detail below in ascending order.

A single review item can be accessed by entering its item number at the "Enter Rev Func #→" prompt.

The following key sequence is used to access charge cycle review data functions.

Keys	Display
Program/Review	Enter →1-REV 2-PROG Function 3-MAH 4-ARCH
1	Enter Rev Func #→01

Key in function number and press enter or scroll using arrow keys to review entire charge cycle (see Fig. 7-2). You may re-enter a new function number at any time to jump through the menu quickly.

01. AMP HOURS RET	The total ampere-hours returned during the charge cycle. This number includes ampere-hours delivered to the battery during the Verify, 0-80%, 80% to End, and Equalize portions of the charge cycle.
02. CHARGE TIME	The total charging time of the charge cycle. This number includes the time of the Verify, 0-80%, 80% to End, and Equalize portions of the charge cycle.
03. 80% TO END	The time the battery was charged from the 80% charged point until DV/DT or VT (depending on the control setting) charge termination. This time does not include any Equalize charging time that may have been automatically or manually selected.
04. BATTERY OCV	The open circuit voltage of the battery immediately before the beginning of the charge cycle.
05. START AMPS	The value of the current delivered to the battery at the start of the charge cycle.
06. START VOLTS	The value of the battery voltage (in volts/cell) of the battery at the start of the charge cycle.
07. FINISH AMPS	The value of the charge current delivered to the battery at the end of the charge cycle.
08. FINISH VOLTS	The value of the battery voltage at the end of the charge cycle.

<p>09. TERM</p> <p>1-Charge Comp 2-Low Current 3-Manual Stop 4-Battery Dis 5-<80 Backup 7-Cooling Int 8-CDAC Rej 9-Curve Error 11-Unbal Line 12-Didt 13-Lvsd 14-Ahsd 15-BID Read</p>	<p>The reason for charge cycle termination. All possible codes are listed below:</p> <p>Normal Charge Complete Low Current Error shutdown Manual stop Battery disconnected while charging 0-80% Back-up Timer Error shutdown. CDAC function CDAC Battery Rejection Charger Output Curve Error shutdown Unbalanced Input Line Error shutdown Rising Current/Falling Voltage Error shutdown Low Charging Voltage Error shutdown Excessive AH Returned Error shutdown BID Error Shutdown</p>	<p>18. BID END TEMP. The temperature of the battery sensed by the Prestolite Battery Identification Module at the end of the charge cycle (degrees F).</p> <p>19. PRESENT TIME The present time (AM/PM format).</p> <p>20. WEEK DAY The present day of week (SUN through SAT).</p> <p>21. EQUALIZE TYPE The type of auto equalize selected. The types that can be selected are listed below:</p> <p>CYC. = By cycle count (see AUTO EQ. COUNT). D.O.W. = By the day of week (see Auto EQ. Day). BID = By BID count</p>
<p>10. EQUALIZE TIME</p>	<p>The time of the equalize portion of the charge cycle. Equalize can be automatically or manually selected.</p>	<p>22. EQUALIZE CYCLES The number of charge cycles between equalize charges when the auto equalize function is programmed "ON" and the auto equalize type is set to "COUNT".</p>
<p>11. START TIME</p>	<p>The time at the start of the charge cycle (AM/PM format).</p>	
<p>12. END TIME</p>	<p>The time at the end of the charge cycle. Includes the equalize time if it was automatically or manually selected (AM/PM format).</p>	<p>23. EQ. DAY The day of the week that an equalize charge cycle is performed when the auto equalize function is "ON" and the auto equalize type is set to "DAY".</p>
<p>13. NOT USED</p>		
<p>14. BATTERY I.D.</p>	<p>The Battery I.D. number of the battery that was charged in the charge cycle. Requires Prestolite Battery Identification Module (BID).</p>	<p>24. AUTO EQUALIZE Shows the auto equalize function on or off.</p> <p>Auto equalize "OFF" Auto equalize "ON"</p>
<p>15. BATTERY VOLTS</p>	<p>The present voltage of the battery connected to the battery charger (volts DC).</p>	<p>25. T.O.D. START Time of day start time. (AM/PM). See START MODE.</p>
<p>16. FAN RUN HOURS (k)</p>	<p>The number of hours (thousands) that the charger fan (if equipped) has run.</p>	<p>26. DELAYED START Delayed start time interval. (00H 00M to 23H 59M). See START MODE.</p>
<p>17. BID START TEMP</p>	<p>The temperature of the battery sensed by the Prestolite Battery Identification Module at the start of the charge cycle (degrees F).</p>	

27. BLOCK START	The beginning time of the time of day blockout function (AM/PM). See START MODE	32. SPECIAL OPTION	Special option modes see below.	
28. BLOCK END	The ending time of the time of day blockout function. (AM/PM). See START MODE.	OFF		
29. START OVERRIDE	The start override function that allows the operator to override any of charger start modes (i.e. delayed start, time of day start, or time of day blockout) by pressing the ENTER key.	"P.T.S."	= Push to start mode.	
30. START MODE	Shows the selected start mode for the start of the charge cycle. AUTO = Automatic mode T.O.D.S. = Time of day start mode DELAYED= Delay start mode T.O.D.B. = Time of day blockout TIMER = Timer Mode	=	The charger will not start until the "ENTER" key is pressed.	
31. FORMING CYCLES	The number of forming cycles for a new battery by disabling the low current shutdown, and setting VT Termination mode for the programmed number of cycles (00 to 30).	F.L.O.	= Fault lockout mode.	
<p>WARNING: Enabling the Finish Cell Forming feature will cause the charger to continue to run for a period of time if the battery has been disconnected before Charge Complete or pressing the Manual Stop key. This condition will continue until the programmed number of cycles have been completed. The battery should never be disconnected while a charge is in progress.</p>	33. CYC. AMP HOURS	The charger will not restart until any faults are reset by pressing the "ENTER" key with no battery connected.	The ampere-hour setting of the charger during the charge cycle. This value cannot exceed the maximum charger output rating.	
	34. CYCLE CELLS	The cell size setting of the charger during the charge cycle. This value cannot exceed the maximum charger output rating.	35. FIXED CELL SIZE	The cell size the charger will operate at if the "multi-cell mode" is not selected and the charger does not detect a Prestolite BID module. See "MULTI-CELL MODE".
	36. FIXED AMP HRS	The ampere-hour size the charger will operate at if the charger does not detect a Prestolite BID module.	37. FIX.BAT.TEMP.	The battery temperature used for charger output voltage compensation, if the charger does not detect a Prestolite BID Module (032 to 132°F).
	<p>CAUTION: Do Not Exceed the Battery Manufacturer's Maximum allowed Battery temperature.</p>	37. FIX.BAT.TEMP.	The battery temperature used for charger output voltage compensation, if the charger does not detect a Prestolite BID Module (032 to 132°F).	

UC2000 CONTROL FEATURES

<p>38. BATTERY TYPE</p> <p>FLD = Standard flooded lead acid industrial type battery curve.</p> <p>CTM. = Custom curve. Uses the voltage and current values programmed in the STRT A/ 100 A.H.,FIN. A/100A.H., GAS. V/C., and LID. V/C.</p> <p>YGR SLR DSG SLE DAG CDR</p> <p>*MAH will be displayed if the Multi-Amp Hour Feature is turned on.</p> <p>39. START AMPS/100</p> <p>40. FINISH AMPS/100</p> <p>41. GASSING V/C</p> <p>42. LID. V/C</p> <p>43. CHARGER I.D.</p> <p>44. REFRESH DELAY</p>	<p>The battery type the charger uses to select the proper output voltage and current characteristic, if the charger does detect a Prestolite BID.</p> <p>= Sealed lead acid battery curves</p> <p>The selected output curve start current setting (10.0 to 16.3 amps per 100 ampere-hours).</p> <p>The selected output curve finish current setting (0.0 to 7.9 amps per 100 ampere-hours).</p> <p>The selected output curve gassing voltage level setting (2.00 to 2.99 volts/cell).</p> <p>The selected output curve lid voltage setting (2.00 to 2.99 volts/cell).</p> <p>The battery charger identification number. This must be set to 0000 unless the battery charger is part of a Prestolite CDAC system. (0000 to 9999)</p> <p>Factory setting = 0000</p> <p>The number of hours before the charger automatically starts and refresh charges a battery that has not been disconnected (8 to 99 hours).</p> <p>Factory Setting = 72 hours.</p>	<p>45. DVDT DISABLE</p> <p>OFF = (DV/DT Mode)</p> <p>ON = (VT mode)</p> <p>46. PRESENT MONTH</p> <p>47. PRESENT DATE</p> <p>48. PRESENT YEAR</p> <p>49. MULTICELL MODE</p> <p>50. COOL DOWN HOURS</p> <p>51. BID CELLS</p> <p>52. BID NUMBER</p> <p>53. BID AMP HOURS</p> <p>Disables the automatic DV/DT charge termination feature and enables Voltage Time charge termination.</p> <p>The current month (1 to 12)</p> <p>The current day of the month (1 to 31).</p> <p>The current year (00 to 99).</p> <p>Enables the automatic cell selection mode of operation for the charger. When turned off, the charger operates at the Fixed cell size (see FIX. CELL SIZE).</p> <p>The number of hours cool down from the end of charge until charge complete is indicated by the charger (0 to 8).</p> <p>If a connected battery is equipped with a Battery I.D. module, the battery cells size (6,9,12,18,24,36) may be re-programmed into the BID. The control must be in "Manual Stop" status.</p> <p>If a connected battery is equipped with a Battery I.D. module, the I.D. number (000001-999999) may be re-programmed into the BID. The control must be in "Manual Stop" status.</p> <p>If a connected battery is equipped with a Battery I.D. module, the battery amp-hour size (0000-9999) may be re-programmed into the BID. The control must be in "Manual Stop" status.</p>
--	---	--

54. BID BATTERY TYPE	If a connected battery is equipped with a Battery I.D. module, the battery type may be programmed into the BID. The control must be in "Manual Stop" status.	57. CYCLE KWH	The number of kilowatt hours used during the last charge cycle.
00 FLD 01 CTM 02 YGR 03 SLR 04 DSG 05 SLE 06 DAG 07 CDR	Flooded Lead Acid Custom curve (programmable) Sealed battery curve Sealed battery curve Sealed battery curve Sealed battery curve Sealed battery curve Sealed battery curve	58. MAX CELL SIZE	Programs the Max Cell Size available on 40 cell chargers in the multi-cell mode. The charger cannot automatically recognize the difference between 40 and 36 cell sizes and therefore the Max Cell Size in that mode must be programmed to 36 or 40 cells. Regardless of this setting 36 or 40 cell batteries with properly programmed Prestolite BID modules will correctly be charged. 36 = 36 Cells 40 = 40 Cells
55. PASSWORD	Optional password required required to program if turned on.	58/59. No Gassing Hours	The number of Hours before the charger can begin the gassing portion of the charging cycle. (0—8 Hours)
56. MAX BATT TEMP	The maximum battery temperature for charging to start or continue. Once interrupted, the charge will restart after the temperature drops 5 degrees F. (For use with BID only)		

ULTRA CHARGE ARCHIVE, REVIEW & PROGRAMMING MENU STRUCTURE

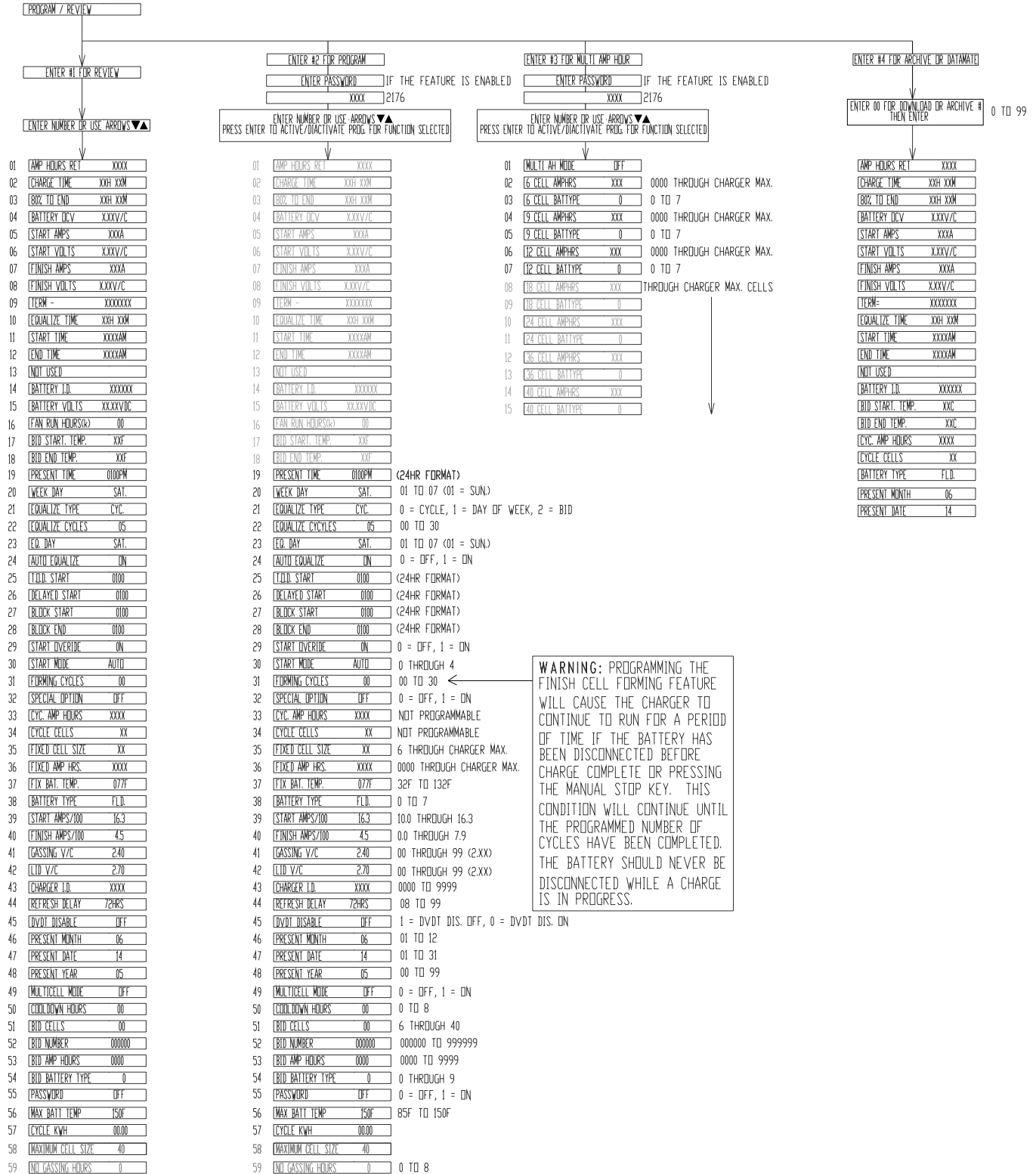

Figure 7-2

Programming Your UC2000 Control

The programming function allows 38 functions to be programmed to customize your Prestolite Ultra Charge to your battery charging application. Programming is not available during an active charge cycle, and can only be accessed before battery connect or after charge termination.

All programmable functions are keyed with the sequence shown below. To prevent unauthorized access, use the optional password feature. Any single programming item can be accessed by entering its function number at the prompt or by using the arrow keys to scroll to the item. If the password feature is used and the improper number is entered, the control will reject access to programming and display "Password Failed". The sequence may then be started over.

Keys Display

Program/Review	Enter → 1-REV 2-PROG Function 3-MAH 4-ARCH
2	Enter Prog Func #

Enter password if required. Key in function number or scroll using arrow keys to reach the desired programming function (see Figure 7-2).

Once the desired function is reached, press the "enter" key to enable programming. Functions 33/34 and 58 are not programmable. On functions with several numeric data fields, the display will show "Enter Numeric Value". The flashing digit will change as the entries are keyed in. Press the "Enter" key again when programming of that function is complete. On functions with 1 or 2 data places, the display will show "Δ ▽ to Change Data". Use the arrow keys to increment or decrement the data. Again press the "Enter" key when programming of that function is complete.

19. PRESENT TIME The current time. Program in 24 hour military time format (0000 to 2359 military time).

20. WEEK DAY The present day of week (SUN through SAT).

Use the up or down arrow to select the proper setting.

- | | |
|---------------------------|--|
| 21. EQUALIZE TYPE | The type of auto equalize selected. The types that can be selected are listed below.

By cycle count (see AUTO EQ. COUNT). Factory setting.

By the day of week (see AUTO EQ. DAY).

By BID cycle count

Use the up or down arrow to select the proper setting |
| 22. EQUALIZE COUNT | The number of complete charge cycles between equalize charges when the auto equalize function is programmed "ON" and the auto equalize type is set to "COUNT" or "BID".

05 = factory setting.

Use the up or down arrow to select the proper setting. |
| 23. EQ. DAY | The day of the week that an equalize charge cycle is performed when the auto equalize function is "ON" and the auto equalize type is set to "DAY".

Saturday = factory setting.

Use the up or down arrow to select the proper setting. |
| 24. AUTO EQUALIZE | Sets the auto equalize function on or off.

Auto equalize "ON" = factory Setting

Use the up or down arrow to select the proper setting. |
| 25. T.O.D. START | Sets the time of day start time (0000 to 2359 military time). See START MODE. |
| 26. DELAYED START | Sets the delayed start time interval (00H 00M to 23H 59M)

Factory = 00H 00M.
See START MODE. |
| 27. BLOCK START | Sets the beginning time of the time of day blackout function (0000 to 2359 military time). See START MODE. |

28. **BLOCK END** Sets the ending time of the time of day blackout function (0000 to 2359 military time). See START MODE.
29. **START OVERRIDE** Sets the start override function that allows the operator to override any of the charger start modes (i.e.; delayed start, time of day start, or time of day blackout).
On = Factory setting
Use the up or down arrow to select the proper setting.
30. **START MODE** Selects the desired start mode for the start of the charge cycle.
Automatic mode
"AUTO" factory setting
Time of day start mode
"T.O.D.S."
Delay start mode
"DEL.S."
Time of day blackout
"T.O.D.B."
Timer TIMER MODE
Use the up or down arrow to select the proper setting.
31. **FORMING CYCLES** Sets the number of forming cycles for a new battery by disabling the low current shutdown and setting VT Termination mode for the programmed number of cycles (00 to 30).
00 = factory setting
Use the up or down arrow to select the proper setting.

WARNING: Enabling the Finish Cell Forming feature will cause the charger to continue to run for a period of time if the battery has been disconnected before Charge Complete or pressing the Manual Stop key. This condition will Continue until the programmed number of cycles have been completed. The battery should never be disconnected while a charge is in progress.

32. **SPECIAL OPTION** Sets special option modes, see below:
OFF factory setting
"P.T.S." Push to start mode
The charger will not start until the "ENTER" key is pressed.
"F.L.O." Fault lockout mode
The charger will not restart until any faults are reset by pressing the "ENTER" key and no battery is connected.
Use the up or down arrow to select the proper setting.
33. **CYC. AMP HOURS** The ampere-hour setting of the charger during the last charge cycle. This value cannot exceed the maximum charger output rating.
Not programmable.
34. **CYCLE CELLS** The cell size setting of the charger during the last charge cycle. This value cannot exceed the maximum charger output rating.
Not programmable.
35. **FIXED CELL SIZE** The cell size the charger will operate at if the "multi-cell mode" is not selected and the charger does not detect a Prestolite BID module. See "MULTI-CELL MODE".
Factory setting = nameplate rating
06 = 6 cells
09 = 9 cells
12 = 12 cells
18 = 18 cells
24 = 24 cells
36 = 36 cells } only available on
40 = 40 cells } 36 & 40 cell units

NOTE: Maximum setting is the charger nameplate rating.

<p>36. FIXED AMP HRS. The ampere-hour size the charger will operate at if the charger does not detect a Prestolite BID module (0001 to nameplate rating).</p> <p>Factory setting = nameplate rating</p> <p><i>NOTE: Maximum setting is the charger nameplate rating.</i></p>	<p><i>NOTE: Functions 39 through 42 apply only to the custom curve and <u>cannot be changed</u> unless the custom curve has been selected in Function 38.</i></p>
<p>37. FIX. BAT. TEMP. The battery temperature used for charger output voltage compensation, if the charger does not detect a Prestolite BID module (032 to 132°F).</p> <p>77° = factory setting</p> <p>CAUTION: Do Not Exceed the Battery Manufacturer's Maximum allowed Battery temperature.</p>	<p>39. START AMPS/100 The custom output curve start current setting (10.0 to 16.3 amps per 100 ampere-hours).</p> <p>Factory setting = 16.3</p> <p>40. FINISH AMPS/100 The custom output curve finish current setting (0.0 to 7.9 mps per 100 ampere-hours).</p> <p>Factory setting = 4.5</p> <p><i>NOTE: For Functions 41 and 42, only information to the right of the decimal point can be entered.</i></p>
<p>38. BATTERY TYPE The battery type the charger uses to select the proper output voltage and current characteristic, if the charger does detect a Prestolite BID.</p> <p>0 = FLD Standard flooded lead acid industrial type battery curve. Factory setting</p> <p>1 = CTM. Custom Curve. Uses the voltage and current values programmed in the STRT. A/100A.H., FIN. A/100A.H., GAS. V/C, and LID. V/C.</p> <p>2 = S.L.A. Sealed Lead Acid battery curve.</p> <p>3 = S.L.R. A charge curve that meets the requirements of some AGM (Absorbed Glass Mat) Type Lead Acid Batteries</p> <p>4 = D.S.G. Sealed Lead Acid battery charge curve that meets the requirements of the EPM "DEKA". Sealed Lead Acid battery.</p> <p>5 = S.L.E. Sealed Lead Acid battery curve.</p> <p>6 = D.A.G. Sealed Lead Acid battery curve.</p> <p>7 = C.D.R. Sealed Lead Acid battery curve.</p> <p>Use the up or down arrow to select the proper setting.</p>	<p>41. GASSING V/C. The custom output curve gassing voltage level setting (2.00 to 2.99 volts/cell).</p> <p>Factory setting = 2.40</p> <p>42. LID. V/C. The custom output curve lid voltage setting (2.00 to 2.99 volts/cell).</p> <p>Factory setting = 2.70</p> <p>43. CHARGER I.D. The battery charger identification number. This must be set to 0000 unless the battery charger is part of a Prestolite CDAC system (0000 to 9999).</p> <p>Factory setting = 0000</p> <p>44. REFRESH DELAY The number of hours before the charger automatically starts and refresh charges a battery that has not been disconnected (8 to 99 hours).</p> <p>Factory setting = 72 hours.</p> <p>45. DVDT DISABLE Disables the automatic DV/DT charge termination feature and enables Voltage Time charge termination.</p> <p>OFF (DV/DT mode) factory setting ON (VT mode)</p> <p>Use the up or down arrow to select the proper setting.</p> <p>46. PRESENT MONTH The current month (1 to 12).</p> <p>47. PRESENT DATE The current day of the month (1 to 31).</p>

- 48. PRESENT YEAR** The current year (00 to 99).
- 49. MULTICELL MODE** Enables the automatic cell selection mode of operation for the charger. When turned off the charger operates at the Fixed Cell Size (see FIXED CELL SIZE).
- OFF
 ON factory setting
- Use the up or down arrow to select the proper setting.
- 50. COOL DOWN HOURS** The number of hours cool down from the end of charge until charge complete is indicated by the charger (0 to 8).
- 0 = factory setting.
- Use the up or down arrow to select the proper setting.

BID Programming

The following conditions must be met before a Prestolite BID can be programmed or reprogrammed with this charger.

- a. A battery with the correct cell size BID must be connected to the charger.
- b. The charger must be in the Manual Stop condition.
- c. The control must be set to the programming menu and functions 51 thru 54 must be selected.

After the above conditions are met the BID can be properly programmed.

After a number entry is keyed in, the control will immediately attempt to program it in the BID while displaying "WRITING BID". If the entered number is out of range or is not accepted by the BID, the control will return to the original prompt with all 0's displayed for the entered data. If the BID properly accepts the data, the programmed number will be returned to the display.

- 51. BID CELLS** Programs the Cell Size into the BID. Once programmed the charger will recognize the battery upon connection, bypass the battery cell size verify function, and charge to the programmed BID cell size.
- 06 = 6 Cells
 09 = 9 Cells
 12 = 12 Cells
 18 = 18 Cells
 24 = 24 Cells
 36 = 36 Cells
 40 = 40 Cells
- 52. BID NUMBER** Programs the battery identification number into the BID. (000000 to 999999)
- 53. BID AMP HOURS** Programs the battery ampere hour rating into the BID. Once programmed the charger will recognize the battery upon connection and charge the battery at the proper charge rates or the max charger output, whichever is greater. (0000 to 9999)
- 54. BID BATTERY TYPE** Programs the battery type into the BID. Once programmed, the charger will recognize the battery type upon connection, and charge the battery with the proper curve.
- 0 = Flooded Curve
 1 = Custom Curve
 2 = Sealed Lead Acid Curve
 3 = Sealed Lead Recombinant Curve Absorbed Glass Mat (AGM) Types
 4 = Sealed Lead Acid Curve ("DEKA" and Other Gel Types)
 5 = Sealed Lead Acid Curve
 6 = Sealed Lead Acid Curve
 7 = Sealed Lead Acid Curve
 8 = ULTRA CHARGE Curve
- 55. PASSWORD** OFF = Factory Setting
 On = Password Enabled
- Use the up or down arrow to select the proper setting.

56. MAX BATT TEMP	The maximum battery temperature for charging to proceed. (For use with BID only) (080 to 150 degrees F)	58/59. No Gassing Hours	The number of Hours before the charger can begin the gassing portion of the charging cycle. (0—8 Hours)
	Factory setting = 150		Factory setting = 00 hours
57. CYCLE KWH	The number of kilowatt hours returned during the last charge cycle. Not Programmable.		Use the up or down arrow to select the proper setting.
58. MAX CELL SIZE	Programs the Max Cell Size available on 40 cell chargers in the multi-cell mode. The charger cannot automatically recognize the difference between 40 and 36 cell sizes and therefore the Max Cell Size in that mode must be programmed to 36 or 40 cells. Regardless of this setting 36 or 40 cell batteries with properly programmed Prestolite BID modules will correctly be charged.		
	36 = 36 Cells 40 = 40 Cells		
	Use the up or down arrow to select the proper setting.		

NOTE: The Max Cell Size function is available on 40 cell charge models only.

Multi AmpHour Programming Your UC2000 Control

The Multi AH Feature of the UC2000 Control allows the user to customize his Ultra Charge to fit his multi-battery application. Using this feature, the flexibility of the Ultra Charge can be used to charge batteries of different Amp Hour capacities and types without using Battery Identification Modules (BIDs) or different chargers with different plug types.

The control can be programmed to charge different voltage batteries with the AH rates and curve types that have been programmed for that battery voltage. When a battery is connected, the control automatically senses the battery voltage and sets the charge curve and charging rates to the level that has been programmed.

The Multi AH functions are programmed through a separate menu item on the control. Complete steps for programming a typical application are listed to the right.

Application

6 cell, 450AH Gel Type Maintenance Free
 12 cell, 680AH Flooded
 18 cell, 744AH Flooded
 750T3-18 Ultra Charge

With the control programmed as shown to the right, the control will charge any 6 cell battery that is connected to the charger at the proper 450AH rates for a *Deka Dominator* Sealed Gel Battery. Any 12 cell battery connected to the charger will be charged at the proper 680AH rates for a standard flooded battery. Finally, any 18 cell battery connected to the charger will be charged at the proper 744AH rates for a standard flooded battery.

By enabling the Multi AH function, any 6,9,12,18,24, and/or 36 cell battery that is equal to or less than the charger rated voltage can be charged at a unique AH rate and with a unique charge curve. For example, 750T3-24 can be programmed to charge 6,9,12,18 and 24 cell batteries with different AH rates and/or different charge curves.

<u>Key Entry</u>	<u>Display</u>
	ULTRA CHARGE
Program Review	Menu Tree 1 – 4
3	Multi AH Mode OFF
Enter	Multi AH Mode OFF
▲	Multi AH Mode ON
Enter	Multi AH Mode ON
▼	6 Cell Amphrs 0750
Enter	6 Cell Amphrs 0750
0450	6 Cell Amphrs 0450
Enter	6 Cell Amphrs 0450
▼	6 Cell Battype▶ FLD
Enter	6 Cell Battype▶ FLD
4	6 Cell Battype▶ DSG
Enter	6 Cell Battype▶ DSG
▼	9 Cell Amphrs 0750
▼	9 Cell Battype▶ FLD
▼	12 Cell Amphrs 0750
Enter	12 Cell Amphrs 0750
0680	12 Cell Amphrs 0680
Enter	12 Cell Amphrs 0680
▼	12 Cell Battype▶ FLD
▼	18 Cell Amphrs 0750
Enter	18 Cell Amphrs 0750
0744	18 Cell Amphrs 0744
Enter	18 Cell Amphrs 0744
▼	18 Cell Battype▶ FLD
Program Review	Menu Tree 1 – 4
Program Review	ULTRA CHARGE

Timer Start Mode Programming Your UC2000 Control

The Timer Start Mode Feature of the UC2000 Control allows the user to override the automatic start/stop features of the control and manually select the desired charge time. This can be useful for charging batteries in a maintenance shop, or for extended equalize charging of batteries with severely mismatched cells.

The Timer Start Mode can be programmed in the Program Menu at Start Mode (function #30). With the Timer Start Mode selected the charger will display CHG CYCLE TIME when a battery is connected. Charge times from 0 hours, 1 minute, to 23 hours, 59 minutes can be entered. Pressing the Enter key will start the charge. The charger will then charge the connected battery based on the any parameters that have been programmed into the control. For example, **constant current charging** can be achieved utilizing the custom curve programming in conjunction with the Timer Start Mode. Listed to the right is an example of programming an Ultra Charge to constant current charge a battery for 20 hours at a 5 amp/100AH rate.

Application

24-Cell 935AH Battery
1050T3-24 Ultra Charge

When programmed and connected as shown to the right, the charger will charge the battery at 48 amps for 20 hours before automatically shutting off.

It should be noted that any programming that is done to set up a special charge (such as Timer Start Mode, Custom Curve, etc.) must be reset to allow resumption of normal charging.

Key Entry	<u>Display</u>
	ULTRA CHARGE
Program Review	Menu Tree 1 – 4
2	Present Time 12:34
30	Start Mode Auto
Enter	Start Mode Auto
▲▲▲▲	Start Mode Timer
Enter	Start Mode Timer
36	Fixed Amp Hrs. 1050
Enter	Fixed Amp Hrs. 1050
0935	Fixed Amp Hrs. 0935
Enter	Fixed Amp Hrs. 0935
38	Battery Type FLD
Enter	Battery Type FLD
1	Battery Type CTM.
Enter	Battery Type CTM.
▼▼	Finish Amps/100 4.5
Enter	Finish Amps/100 4.5
50	Finish Amps/100 5.0
Enter	Finish Amps/100 5.0
▼	Gassing V/C 2.40
Enter	Gassing V/C 2.40
00	Gassing V/C 2.00
Enter	Gassing V/C 2.00
▼	Lid V/C 2.70
Enter	Lid V/C 2.70
99	Lid V/C 2.99
Enter	Lid V/C 2.99
Program Review	Menu Tree 1 – 4
Program Review	ULTRA CHARGE

On battery connection, the control will ask for the cycle charging time to be entered. Key in 20 hours and press the “enter” key.

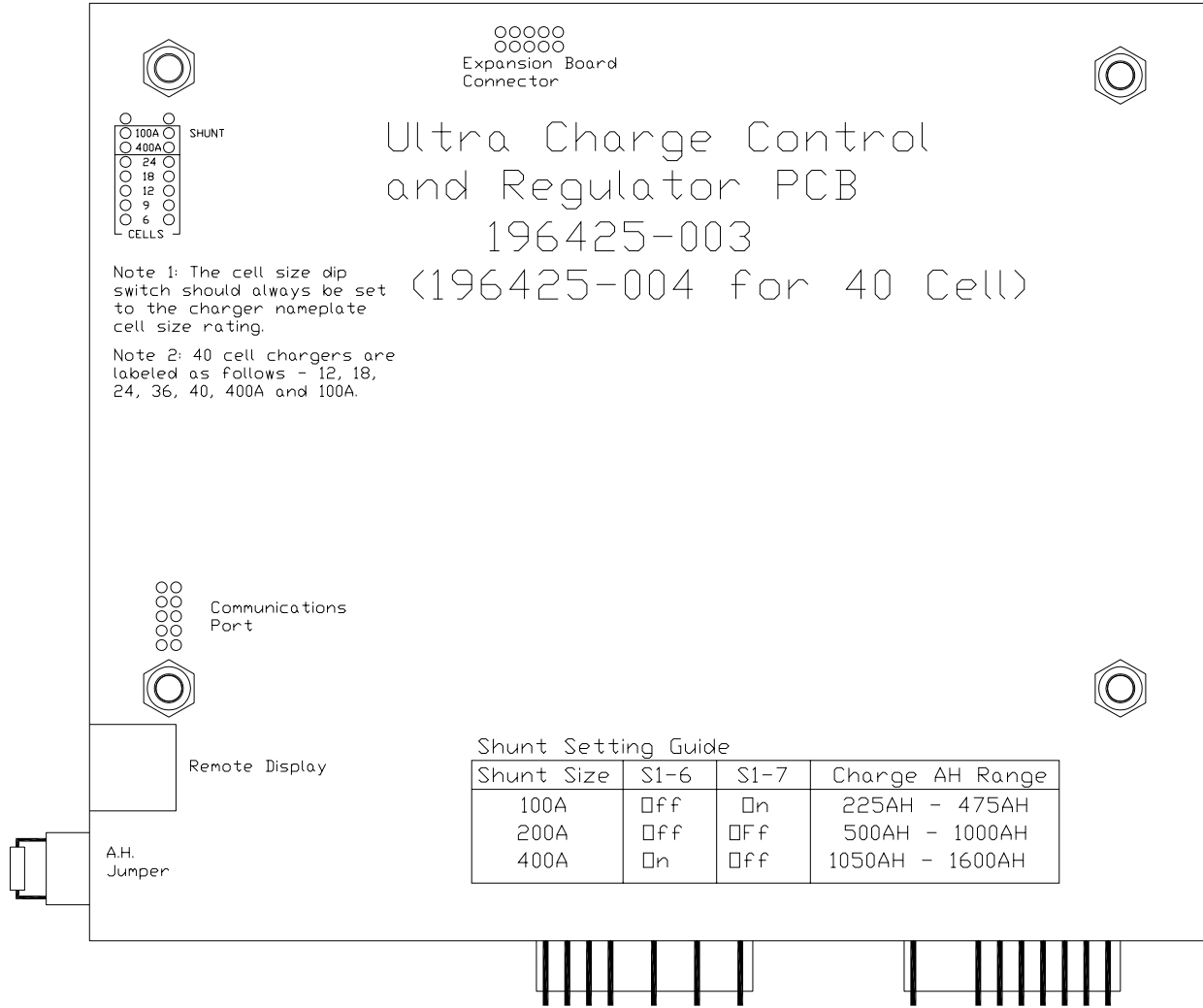

Charger AH	Res. Value	P/N
300	5.76K	192302-002
500	4.32K	192302-001
550	4.99K	192302-006
600	5.76K	192302-002
650	2.32K	192302-005
750	8.45K	192302-003
850	10.7K	192302-004
1050	4.32K	192302-001
1200	5.76K	192302-002
1400	7.32K	192302-008

Figure 8-1

OPTIONS

The options listed in the following table of contents are those most commonly available. Special options not listed here will be covered by enclosed "addendum" sheets.

OPTION DESCRIPTION	PAGE
Parallel Charging	9-1
Series Charging	9-1
Fused Disconnect Switch and 24-V Control Circuit	9-2

Parallel Charging

This option provides cables allowing two batteries to be charged at the same time (batteries connected in parallel to charger).

To prevent premature charger turn on, this option requires the use of a battery connector with auxiliary contacts (Anderson "SBX" or equivalent). The same type connector must be specified on the battery and vehicle. The connector on the battery must have the auxiliary contacts jumpered together.

NOTE: The safety interlock circuit is protected by an in-line 1 Amp AGC Fuse inside the battery charger.

When charging two batteries, each must be of the same voltage (or number of cells). The total rated ampere-hour capacity of both batteries plus the voltage (number of cells of only one of the batteries) must be within the range of the charger. Refer to charger nameplate for ratings. For example: two 12-volt (6 cell), 225 ampere-hour batteries would make a 12-volt (6 cell), 450 ampere-hour load.

Operate this charger as instructed in Operation chapter of this manual except that batteries are to be connected as shown in Figure 9-1, plus the total ampere-hour capacity must be used to calculate charging time.

CAUTION: Make sure all connections are made positive to positive and negative to negative as shown.

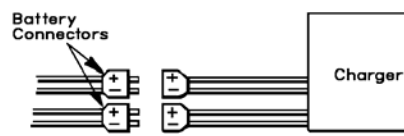

Figure 9-1 Parallel Charging Connections

- No. 1/0 size cable for 555-680 AH.....P/N 397891-4
- No. 2/0 size cable for 681-910 AH.....P/N 397891-5
- No. 3/0 size cable for 911-1050 AH.....P/N 397891-6
- No. 4/0 size cable for 1051-1270 AH.....P/N 397891-7

Series Charging

This option provides a cable allowing two batteries to be charged at the same time (batteries connected in series to charger).

- Series cables for 555-680 AH.....P/N 396820-4
- Series cables for 681-910 AH.....P/N 396820-5
- Series cables for 911-1050AH.....P/N 396820-6
- Series cables for 1051-1270AH.....P/N 396820-9

CAUTION: With the batteries required to be connected in series, this charger cannot be used to charge one battery only.

Both batteries must be of the same ampere-hour rating. The total rated voltage (or number of cells) of both batteries (add the two), plus the ampere-hour capacity of only one battery, must be within the charger name-plate range ratings. For example: two 12-volt (6 cell), 450 ampere-hour batteries would make a 24-volt (12-cell), 450 ampere-hour load.

NOTE: For series charging, both batteries must be at identical depths of discharge (DOD); i.e., they are used in series in the vehicle. A mismatch in DOD of the two batteries will result in severe overcharge of the lightly discharged battery and severe undercharge of a deeply, discharged battery.

Operate this charger as instructed in Operation chapter of this manual, except that charger must be connected to both batteries instead of just one. Refer to Figure 9-2.

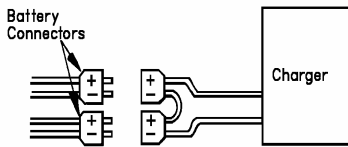

Figure 9-2 Series Charging Connections

CAUTION: Make sure all connections are made positive to positive and negative to negative as shown.

Extra Length Output Cables

	5 Ft Extra	10 Ft Extra
No. 1/0 size for 555-680 AH	396143-64	396143-67
No. 2/0 size for 681-785 AH	396143-65	396143-68
No. 3/0 size for 786-1050 AH	396143-75	396143-78
No. 4/0 size for 1051-1270 AH	396143-76	396143-88

Fused Disconnect Switch

(Refer to Figure 9-3)

To order “JIC” disconnect chargers, add “-002” to the base Spec No. Example:
 680T3-12 w/Opt. 500 = Spec 500659-002

This option is provided to meet certain “JIC” requirements. The switch must be in the open (OFF) position to disconnect all AC power going into the charger and to allow front door to be opened. With switch in open position, door can be opened by turning slotted latch screw to the left.

Disconnect switch is for *emergency or service use* only.

Charge cycle should continue until automatically shut off. If cycle must be interrupted, press the “STOP” key. A control circuit operating on 24 volts is also provided to help assure operator safety.

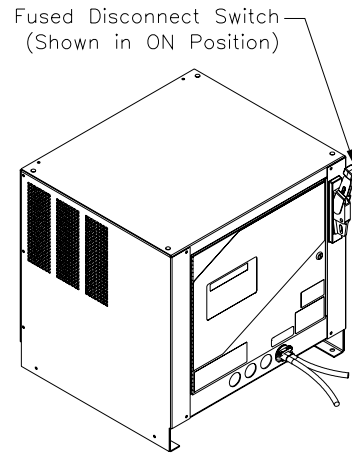

Figure 9-3 Fused Disconnect Switch

CDAC Expansion Kit

Ultra Charge CDAC Expansion Kit.....192355-1

This option is required for communications with the Host Computer of a Prestolite CDAC (Charger Data Acquisition and Control) System.

Remote Display Kit

Ultra Charge Remote Display Kit.....192356-1

A remote display kit is available for applications where the charger display is inaccessible or not visible. It allows remote control of Manual Stop and Equalize functions, as well as LED Status indicators.

This remote control box must be connected to charger as instructed on label provided with remote charge control. Operate the charger as instructed in Operation chapter of this manual and as instructed under any applicable option descriptions.

Wall Mounting Bracket

Wall Mounting Bracket.....390850-2

Facilitates wall mounting of T Case Chargers.

Lifting Eye Kit

Lifting Eye Kit.....191652

Facilitates lifting of T Case Chargers.

Archive Downloading Kit

Prestolite Data Link Kit.....193026

This kit is available to allow the user to download Ultra Charge archive data using the front door mounted data port to a laptop PC via the PC's Serial Port. Data is stored in a "text" file format that can be imported into most popular spreadsheet programs.

Remote Stop Pushbutton Kit

Remote Stop Pushbutton Kit.....196400-1

A Remote Stop Pushbutton Kit is available for applications where the charger control is not readily accessible or where an emergency stop pushbutton is desired. This mushroom-head pushbutton must be connected to the charger control per instructions provided in the kit. A 20 ft long modular cable is furnished with the kit for this purpose. The charger may be stopped at either location – the remote stop pushbutton or the charger control.

TROUBLESHOOTING

Troubleshooting Table

SYMPTOM	PROBABLE CAUSES	ACTION STEPS
No Display And No LED's	(1) No AC Voltage To Charger	1
	(2) Input Fuse(s) Blown	2
	(3) Control Trans. Breaker Tripped	3
	(4) Control Trans. Bad	4
	(5) Wrong Control Trans. Connection	5
	(6) Bad Harness/Connection – Loose or Incorrect	6
	(7) Bad Control Board	7
No Keypad Response	(1) Keypad Not Connected	8
	(2) Keypad Connected Improperly	8
	(3) Bad Control Board	7
	(4) Bad Keypad	9
Bad Lamp Test	(1) Keypad Not Connected	8
	(2) Keypad Connected Improperly	8
	(3) Bad Control Board	7
	(4) Bad Keypad	9
Display Illegible	(1) Noisy Environment	10
	(2) Low Input Voltage	11
	(3) Bad Control Board	7
Charger Doesn't Respond To Battery Being Connected	(1) Output Fuse Bad	12
	(2) Bad Harness/Connections – Loose Or Incorrect	6
	(3) Bad Control Board	7
	(4) Output Cables Reversed	13
	(5) Bad Output Connector	14
Control Not Responding (Locked Up)	(1) Noisy Environment	10
	(2) Bad Suppressor Core	15
	(3) Low Input Voltage	11
	(4) Power Interruption	10

SYMPTOM	PROBABLE CAUSES	ACTION STEPS
Unit Smells Hot	(1) Inadequate Ventilation (2) Ambient Too Hot (3) Lack of Maintenance (4) Bad Transformer (5) Bad Control Transformer (6) Bad Internal Power Connection (7) Bad Control Board (8) Bad Inductor (9) Wrong Amp/Hour Jumper (10) Bad Expansion Board	16 17 19 20 4 21 7 22 23 24
Battery has Low S. G.'s	(1) Reading Not Temperature Corrected (2) Bad Battery (3) Bad Equalize Schedule (4) Charge Curve Incorrect (5) Rates Set Incorrectly (6) Fixed Temperature Set Incorrectly (7) Too Cold (8) Bad BID (9) Not Enough Charging Time	25 26 27 28 29 30 31 32 37
Battery Doesn't Last Full Shift	(1) Faulty > Lift Interrupt (2) Manual Disconnect (3) A.H. Required > Battery Nameplate (4) Battery Not Providing Nameplate Rating (5) Equalize Schedule (6) Charge Curve Incorrect (7) Rates Set Incorrectly (8) Fixed Temperature Set Incorrectly (9) Bad BID (10) Charger Too Small For Battery (11) Not Enough Charging Time	33 34 35 26 27 28 29 30 32 29 37
Battery Water Usage Is Too High	(1) Rates Set Incorrectly (2) Fixed Temperature Set Incorrectly (3) Charge Curve Incorrect (4) Equalize Schedule (5) Control On Forming Cycles (6) Control On Voltage/Time (7) Bad BID	29 30 28 27 36 38 32

SYMPTOM	PROBABLE CAUSES	ACTION STEPS
Low Number Of A.H.'s Returned To Battery	<ul style="list-style-type: none"> (1) Faulty Lift Interrupt (2) Battery Not Fully Discharged (3) Manual Disconnect (4) Rates Set Incorrectly (5) Fixed Temperature Set Incorrectly (6) Charge Curve Incorrect (7) Battery Not Providing Nameplate Rating (8) Bad Control Board (9) Bad BID 	<ul style="list-style-type: none"> 33 39 34 29 30 28 26 7 32
Battery Temperature Too High	<ul style="list-style-type: none"> (1) Insufficient Cool Down Before And/Or After Charging (2) Battery Power Demand Too Great (3) Rates Set Incorrectly (4) Fixed Temperature Set Incorrectly (5) Charge Curve Incorrect (6) Equalize Schedule (7) Control Set For Voltage/Time (8) Control Set For Cell Forming (9) Bad BID 	<ul style="list-style-type: none"> 40 41 29 30 28 27 38 36 32
Incorrect Charge Rate	<ul style="list-style-type: none"> (1) Rates Set Incorrectly (2) Fixed Temperature Set Incorrectly (3) Charge Curve Incorrect (4) Battery A.H. Not Equal To Charger A.H. (5) Battery Has Incorrect Size BID (6) Bad Control Board (7) BID not Programmed Properly 	<ul style="list-style-type: none"> 29 30 28 33 32 7 32
Long CDAC Approval Delay	<ul style="list-style-type: none"> (1) Bad CDAC Cabling (2) CDAC System Down (Computer) (3) No AC To Control Of 1 Or More Chargers (4) No CDAC System And Charger I.D. In Control isn't set to "0000" (5) Bad Expansion Board (6) Bad Control Board 	<ul style="list-style-type: none"> 42 43 44 45 24 7

SYMPTOM	PROBABLE CAUSES	ACTION STEPS
Doesn't Shutdown When Battery Is Disconnected	(1) Control Set For Forming Cycles (2) Bad Control Board (3) Bad/Incorrect Shunt	36 7 55
Noisy Unit	(1) Loose Sheet Metal (2) Bad Contactor (3) Loose Transformer Mounting (4) Loose Inductor Mounting (5) Noisy Inductor (6) Noisy Transformer (7) Placed On Rack That Makes Noise	46 47 48 49 50 51 52
Erratic Operation	(1) Bad Control Board (2) Bad SCR (3) Bad SCR Gate Connection (4) Control Wiring Loose From Heat Sink (5) Bad Harness/Connection – Loose Or Incorrect (6) Bad Power Connection (7) Bad Output Cable Connector (8) Bad Inductor (9) Moisture Inside Cabinet (10) Lack of Maintenance (11) High Ambient Temperature	7 53 20 20 6 21 14 22 54 18 17
Meter Reading Wrong (V/C)	(1) Bad Output Connect (2) Bad Harness/Connections – Loose Or Incorrect (3) Internal Power Connection (4) Bad Control Board	14 6 21 7
Meter Reading Wrong (Amps)	(1) Bad Output Connector (2) Bad Harness/Connections – Loose Or Incorrect (3) Internal Power Connection (4) Bad Control Board (5) Bad/Incorrect Shunt	14 7 21 7 55

SYMPTOM	PROBABLE CAUSES	ACTION STEPS
Display reads Unbalance Line Fault	(1) Incorrect Wiring To Primary Of Transformer	56
	(2) Incorrect Cabling To Transformer Secondary	57
	(3) Bad Harness/Connections – Loose Or Incorrect	6
	(4) Bad SCR	53
	(5) Bad Diode	58
	(6) Bad Control Board	7
	(7) Gate Lead Connections	20
	(8) AC Supply	1
	(9) Bad Transformer	19
High Input Current	(1) Incorrect Wiring To Primary Of Transformer	56
	(2) Incorrect Cabling To Transformer Secondary	57
	(3) Incorrect AC Input Jumper Setting	59
	(4) Bad Harness/Connections – Loose Or Incorrect	6
	(5) Bad SCR	53
	(6) Bad Diode	58
	(7) Bad Control Board	7
	(8) Gate Lead Connections	20
	(9) AC Supply	1
	(10) Bad Transformer	19
	(11) Bad Inductor	22

SYMPTOM	PROBABLE CAUSES	ACTION STEPS
Display Reads (Curve Error Fault)	(1) Bad Harness/Connections – Loose Or Incorrect (2) Bad SCR (3) Bad Diode (4) Bad Control Board (5) Incorrect Wiring To Primary Of Transformer (6) Bad Shunt	6 53 58 7 56 55
Display Reads (Backup Timer Fault)	(1) Fixed Temperature Set Incorrectly (2) Bad A.H. > Charger A.H. (3) Bad Output Cable Connector (4) Incorrect Charge Curve Setting (5) Bad Battery (6) Bad BID	30 33 14 28 26 32
Display Reads (Manual Stop Fault)	(1) Someone Pressed Manual Stop Button (2) Bad Connection (Keypad-Control) (3) Bad Keypad (4) Bad Control Board	34 8 9 7
Display Reads (Low Current Fault)	(1) Fixed Temperature Set Incorrectly (2) Bad Harness/Connections – Loose Or Incorrect (3) Battery Not Fully Formed (4) Bad Battery (5) Bad A.H. > Charger A.H. (6) Bad Internal Power Connection (7) AC Supply (8) Bad AC Fuse (9) Bad Contactor (10) Output Fuse Bad (11) Bad Control Board ((14) Bad Transformer (15) Bad Or Wrong Size Shunt	30 6 60 26 61 21 1 2 47 12 7 19 55

SYMPTOM	PROBABLE CAUSES	ACTION STEPS
Display Reads (Low Battery Fault)	(1) Fixed Cell Setting Incorrect (2) Bad Harness/Connections – Loose Or Incorrect (3) Bad Battery (4) Bad Control Board (5) Bad Output Cables/Connector (6) BID not Programmed Properly	62 6 26 7 14 32
Display Reads (Hi Battery Fault)	(1) Fixed Cell Setting Incorrect (2) Bad Battery (3) Bad Control Board (4) BID not Programmed Properly	62 26 7 32
Display Reads (Setup Error Fault)	(1) Shunt Size Setting Has Been Changed On Control Board (2) Cell Size Setting Has Been Changed On Control Board (3) A.H. Resistor Has Been Changed On Control Board (4) Bad Keypad Connection (Keypad-Control) (5) Bad Keypad (6) Bad Control Board	63 64 65 8 9 7
Display Reads (Check AC Power)	(1) Intermittent AC Fail (Supply) (2) Control Transformer Connection (3) Bad Harness/Connection – Loose Or Incorrect (4) Bad Control Transformer (5) Bad Control Board	1 5 6 4 7

193111-068
TROUBLESHOOTING

SYMPTOM	PROBABLE CAUSES	ACTION STEPS
Display Reads (Control Error COP)	(1) Noise (Supply) (2) Bad Control Board (3) Bad Suppressor Core	10 7 15
Display Reads (Control Error Clock Monitor)	(1) Noise (Supply) (2) Bad Control Board	10 7
Display Reads (Control Error Illegal Opcode)	(1) Noise (Supply) (2) Bad Control Board	10 7 15
Display Reads (DIDT Fault)	(1) Bad Battery (2) Bad Control Board (3) Bad BID	26 7 32
Display Reads (High Amp Hour Fault)	(1) Bad Battery (2) Bad Control Board	26 7
Display Reads (Low Voltage Fault)	(1) Bad Battery (2) Bad Control Board (3) Bad Power Connection	26 7 21
Display Reads (Bad BID Fault)	(1) Bad BID (2) Bad Power Connection (3) Bad Harness/Connections - Loose or Incorrect	32 21 6

Action Steps

1. Reference the INSTALLATION chapter (pg. 4-1).
2. Disconnect AC power and replace the bad AC fuse. Reapply AC power to the charger. If the fuse (s) blows instantly, check the connections on the input side of the contactor to make sure there are no shorts between any of the input wires. If that's okay, then check or change the control transformer. If the fuse(s) blow after the contactor closes, then check the input wiring from the contactor to the main transformer (s). Refer to the DIAGRAM chapter and locate the diagram for your charger to confirm that the charger is wired correctly. Also check the wires going up to the terminal block on the transformer; the wires will have numbers that correspond to the number on the terminal block. If they are incorrect, change them and start over. If it still blows fuse (s), the transformer will have to be replaced.
3. Reset the breaker. Disconnect the control and reapply AC power to the charger. Measure to see if 24VAC is on the output side of the control transformer. If there is, the control has failed. If there isn't 24VAC, then replace the control transformer. It is still possible that the control has failed; so once the control transformer is replaced, measure to see if the 24VAC drops once the control is connected.
4. Check and see if any input fuses are blown. Visually inspect the control transformer for discoloration on the casing of the input side of the control transformer. Disconnect the control before applying AC power. Once AC power is reapplied, measure the input voltage to the control transformer; it should be the AC supply voltage (208/240/480). If not, check the control transformer input wiring. If you did read the supply voltage, then measure the output side and you should read 24VAC. If not, replace the control transformer.
5. Look at the casing of the control transformer on the input side. Reference the DIAGRAM chapter to determine the input. There will be four pins and each one will be labeled as follows: COM (common), 208 (208VAC), 240 (240VAC), and 480 (480VAC). Some models may have a 575 (575VAC) pin. There should always be a wire on the common pin no matter what voltage is applied to the charger, and the second wire will go to the pin labeled as the voltage that is applied to operate the charger. Measure the voltage on the output side of the control transformer, it should read approximately 24VAC.
6. A bad harness/connection can cause many different problems. The best way to confirm a bad harness/connection problem is to take measurements where the harness is connected to the charger and then follow the wire (s) up the harness to the PC boards and measure there also. The measurement should match what was measured at the charger connection. If it doesn't, check the following: Check the connectors at the square plugs where the control harness connects to the charger harness; the connectors could be pressed out of the plugs. Make sure the connectors look okay inside the edge mount connector at the PC board (s). Make sure the harness connections are tight where they connect to the charger. Make sure the wires are crimped to the terminals tightly and also check to make sure that they are crimped to the bare wire and not to the insulation only.
7. To check the Control Board for proper operation, first check the DIP Switch settings of S1. Make sure the shunt size and cell selections match the charger, see the nameplate. For a 200A shunt, the 100A and 400A switches should be open. They should both be closed for a 600A shunt. Check the voltages between J10-1 (gnd) and the following points, they should be within 5% of the voltages given: J10-2 = 3.00V, J10-3 = 12.00V, and J10-4 = 5.00V. J10 is located at The bottom left of the PCB.

If the charger operates normally except there is no alphanumeric display, the check the connection from the display to the Control Board. Replace the Control Board if the connection is correct.

If the charger still does not work properly even though the above settings and voltages are correct, the Control Board may need replaced. However, this is unlikely and all other possibilities should be checked before taking this step.

8. Look at the inside of the door and locate the Control Board. (Reference the illustrated Parts List for locations). The keypad is connected to the Control Board. Look up between the Control Board and the inside of the door. You should be able to see the keypad ribbon cable. The ribbon cable should be connected to a pin header on the Control Board. If it's not connected, or looks questionable, remove the Control Board and correct it.
9. With no battery connected to the charger, press all of the keys on the keypad and the display should indicate that the button did function. The only exception will be the Equalize and Stop keys. To test them, connect a battery and allow the charger to start, then press the button. The ULTRA CHARGE was shipped set for automatic equalize which means unless this was changed, the Equalize button will not respond. To find out if the Status LED's on the keypad are okay, press key number "0" and a complete review will occur that starts out by performing a lamp test which lights all the Status LED's.

10. Temporarily shut down any equipment on the same voltage supply line and see if the charger starts to respond normally. If the charger does, then check all grounds going to the equipment that is shut down. If the problems still exist, then return power to all the other equipment and call your local PRESTOLITE POWER Representative.
11. Measure the AC supply voltage coming into the charger to confirm that it matches the charge input tap settings.
12. Use an Ohmmeter and measure directly across the DC Fuse. A good fuse will measure almost (0) Ohms and a bad one will measure a very high resistance, in the megohm range or greater. If for some reason a DC Fuse measures somewhere in between, replace the DC Fuse and send it in to your local PRESTOLITE POWER Representative.
13. Refer to the DIAGRAM chapter in the owners manual and locate the diagram for your charger to determine where the output cables connect to the charger. The black (Negative) output cable goes into the charger and connects to a bus bar on the end of the DC Fuse which is located on the left side of the unit. The red (Positive) output cable goes into the charger and connects to the leads of the inductor that is located on the right of the charger base. The output connector will have a (+) and (-) symbol on it. The (+) terminal should have the red output cable connected to it, and the (-) should have the black output cable connected to it.
14. Make sure the output connector does not have any cracks on its casing that could result in a short. Make sure the output cable lugs are making a good connection with the battery connector. You will see traces of pitting on the lug surface from arcing if there isn't a good connection. This could be the result of a weak retainer clip in the connector or lugs that were soldered on incorrectly. If the lugs had too much heat applied to them when the cables were soldered on, the solder will wick up the cable and make it very stiff. When they are inserted into the connector, the stiff cable forces the retainer clip down and creates poor connection between the battery connector and the charger connector.
15. Make sure the suppressor core is attached to the control wire harness with the green wire outside the core, and that it is not missing. Visually inspect the suppressor core for missing pieces or cracks. If so, replace the suppressor core.
16. Refer to the INSTALLATION chapter and go to the paragraph labeled "LOCATION". This will define the guide lines. If a charger has inadequate ventilation, many different problems can occur. If a charger runs under extreme temperatures, any component inside the charger could fail prematurely.
17. An extremely high ambient temperature can cause many different problems. If a charger runs under extreme temperatures, any component inside the charger could fail prematurely.
18. Refer to the MAINTENANCE chapter in the manual. Electrical parts tend to attract dust and dirt after a long period of time, which can cause parts to fail prematurely. If the unit is equipped with a fan, be sure it is in operating condition.
19. AC fuses are most likely to have failed. Visually inspect the transformer. If a winding has failed, the winding will appear to be burnt or look black. The varnish might be flaking off. Refer to the DIAGRAM chapter in the manual and locate the diagram for your charger. On the diagram there will be a winding configuration of the transformer. Disconnect the SCRs and diodes from the transformer and reapply AC to the charger. Measure the transformer secondary voltage, if less than 25VAC is present, replace the transformer.
20. Visually inspect for loose connections on the heat sink or components on the control board that appear to be bad. There are suppressors on the board that are designed to absorb energy surges. If the surge is too high the component will fail. It will be very dark in color or cracked.
21. Do a continuity or resistance test. Check for connection points that visually appear to have been exposed to extreme heat. Any connections that appear loose or overheated must be re-lugged and rechecked.
22. Connect a fully charged battery to the charger. Make sure that the charger is set to its maximum Fixed AH capacity (See the Programming Your UC2000 Control chapter in this manual). If the input current exceeds the nameplate rating (by more than 10%) for the input voltage range that the charger is connected to, replace the inductor. Also inspect the inductor for dark horizontal areas on the coil insulation. If any significant discoloration of the inductor is found, it should be replaced.
23. If the AH jumper is incorrect for the charger, it will cause the unit to charge at rates either higher or lower than nameplate rating.

24. To check the expansion board for proper operation, first make sure there is a good connection to the UC2000 Control board. The connection is in the lower center of the expansion PC board. Looking at the inside of the door, check the voltages at the following points: across C20 – 18 to 35 VDC, across C12 – 4.75 to 5.25 VDC, and across C19 – 4.75 to 5.25 VDC. Observe polarity when making these measurements. Check for the proper Charger I.D. number in function 43 (See the Programming Your UC2000 Control chapter of this manual) if the problem is long CDAC approval delays. Also check the CDAC cables for proper insertion or damage.
- If the expansion board still does not work after these checks and/or if any of the voltage measurements are incorrect, replace the expansion PC board.
25. Specific Gravity readings vary with the temperature of the electrolyte. To temperature correct the Specific Gravity readings to match the nameplate ratings of the battery, use the following rule of thumb; + 1 S.G. point per 3° F that the electrolyte temperature exceeds 77° F.
26. Take Specific Gravity readings and measure Cell Voltages. If acid has been spilled or the battery has been extremely heated, it is possible that a battery's capacity could be greatly reduced, and the acid is not capable of increasing to the battery nameplate rating.
27. The proper equalize schedule is one that is tailored to the specific battery and charger operation. The UC2000 Auto Equalize feature can be used to automate the equalize schedule (See the UC2000 Features chapter of this manual).
- Excess equalizing causes increased water usage. Too little or no equalizing can lead to battery sulfation and/or decrease battery shift run times. Adjusting the auto equalize number of cycles can improve the equalize performance (See the Programming Your UC2000 Control chapter of this manual). Some operations may also benefit from day of week or by BID cycle equalizing. This can be programmed by the Auto EQ type function to the UC2000 Control (See the Programming Your UC2000 Control chapter of this manual).
28. Using the Review feature of the control (See the Control Features chapter of this manual), check the charge curve setting of the charger. If it does not match the Battery Type (Standard, Sealed, Custom), reprogram the control to the proper curve. (Refer to the Programming Your UC2000 Control chapter of this manual).
29. Using the Review feature of the control (See the Control Features chapter of this manual), check the Fixed AH setting of the charger. If it does not match the battery nameplate rating of the battery (it should be within 20% of the battery nameplate rating), reprogram the control to the proper Fixed AH rating (Refer to the Programming Your UC2000 Control chapter of this manual). If this is not possible due to the maximum rating of the charger, a larger charger should be used.
30. Refer to Program chapter. Go to function number 37 and confirm that the control is set for the correct Fixed Temperature Setting. If not, enter the correct setting.
31. If battery electrolyte temperatures are well below 32° F, the ULTRA CHARGE will not be able to adequately charge the battery. Battery insulation or heaters would be required to keep the battery electrolyte temperatures close to 32°F.
32. The BID module communicates battery temperature, cell size, voltage, ampere hour size, BID no. , and type to the charger. A nonfunctioning or incorrectly programmed BID can cause charging and /or battery problems. Using the UC2000 Review Features (See the UC2000 Review Features in this manual), check the review items listed above. Replace a nonfunctioning or incorrectly programmed module with a new one.
33. A faulty lift interrupt on a lift truck can cause the battery to be over or under discharged. Check the interrupt voltage of the interrupt following the procedures found in your truck and/or lift interrupt operator's manual (s).
34. When it is necessary to stop the charge cycle before charge complete, *always terminate the charge cycle by pressing the STOP key before disconnecting the battery from the charger.*

35. If the application requires a larger AH battery than is presently in use, the only long term solution is to replace the battery with one of the proper AH rating.
36. If the control is set to perform forming cycles, DV/DT termination is disabled, and the low current shutdown is disabled. To return to normal operation, program the control to "00" Forming Cycles (See the Programming Your UC2000 Control chapter of this manual).
37. Not enough charging time - In cases where opportunity charging is taking place, more time charging may be needed to keep the battery within its proper operating range. Be sure that the battery is charged per the users operations guidelines. Those procedures may need to be adjusted to allow for more charging time or less battery load.
38. Program the control to DV/DT charge termination (See the Programming Your UC2000 Control chapter of this manual).
39. If fully discharged batteries are desired for efficient operations, lift interrupts can be installed on the trucks to allow the operators to recognize a fully discharged battery.
40. In opportunity charging applications, higher than normal battery temperatures should be expected. In cases where the temperature is exceeding a reasonable value, utilize the battery cooling feature of the UC2000 Control or adjust the battery use versus charging schedule to allow for lighter loads on the battery. In a standard charging mode, a cool down can be programmed into the UC2000 Control to add a specified cool down time between charge termination and the signaling of charge complete (See the Programming Your UC2000 Control chapter of this manual). A delayed start can be programmed into the UC2000 Control to add a specified delay time between battery connection and the start on the charge (See the Programming Your UC2000 Control chapter of this manual).
41. Battery is being discharged at too high (fast) of a rate. Consult the battery manufacturer or distributor for applications assistance.
42. Check and repair/reconnect connections between the last charger that is polling properly and the next charger connected (See your CDAC Owners Manual).
43. Reboot computer and select "Restart CDAC after abnormal termination" menu item (See your CDAC Owners Manual).
44. Check for control operation on all CDAC connected chargers down stream of the last connected charger that is polling properly (or all CDAC connected chargers). Loss of AC power connections or proper control transformer voltage will prevent proper CDAC operation (See CDAC Owners Manual).
45. The Charger I.D. function in the UC2000 Control must be set to 0000 for proper normal (non-CDAC) operation (See the Programming Your UC2000 Control chapter of this manual).
46. Check and tighten all sheet metal fasteners (screws and bolts).
47. Check the voltage across the contactor coil. If the voltage is 24VAC +/- 10%, replace contactor with a properly functioning part.
48. Check and tighten all transformer mounting screws.
49. Check and tighten all inductor mounting screws.
50. Check inductor for visible damage. Coat the transformer coil with a Prestolite approved (contact Prestolite Service) air dry varnish. If that fails to reduce the noise level, drive a shim of the proper material (contact Prestolite Service) between coil and core.
51. Check transformer for visible damage. Coat the transformer coil with a Prestolite approved (contact Prestolite Service) air dry varnish. If that fails to reduce the noise level, drive a shim of the proper material (contact Prestolite Service) between coil and core.
52. Check for and tighten any loose fasteners on the rack. Remove any lightweight loose objects that are on the rack near the charger.

53. Check the SCR as described below. If it tests faulty, replace with an SCR of the proper type.
Connect a VOM set on the 1k Ohms scale; positive to SCR anode (stud), negative to SCR cathode (heavy red lead). The VOM should read a very high impedance (near open circuit). Touch and hold the SCR gate lead (small white lead) to the SCR anode. The VOM should read a low impedance (near short circuit). If the SCR reads shorted before the gate is touched to the anode, the SCR is bad. If the SCR reads open when the gate is touched to the anode, the SCR is bad (A DVM may be used if it is set to the Diode scale). A high impedance will be indicated by an over range indication (usually OL), a low impedance will be indicated by a low reading 1.00.
54. Disconnect the charger from the battery and the input AC. Blow out the charger with compressed air, and allow the unit to set unused for 1 to 2 weeks in a warm dry environment (as hot, up to 104° F) and dry as possible.
55. Replace damaged and/or incorrect shunt with one of correct size.
56. Reconnect transformer primary wiring to match the schematic included in this manual.
57. Reconnect transformer secondary wiring to match the schematic included in this manual.
58. Using a VOM or DVM, check the diode for proper operation as stated below.
Set the VOM to the 1k Ohms scale. Connect the positive VOM lead to the anode (cable lead) and the negative VOM lead to the cathode (stud). The VOM should read a low impedance (near short circuit). Reverse the VOM leads. The VOM should read high impedance (near open circuit). Replace any diodes that fail with the proper part.
59. Reconnect the input primary jumpers to match the input voltage, see the installation chapter of this manual. *Be sure to connect the control transformer primary properly.*
60. Program the forming cycles feature of the UC2000 Control to the number of cycles required to properly form the battery. See the Programming Your UC2000 chapter of this manual.
61. Reprogram the fixed AH setting of the UC2000 Control to match the battery nameplate AH rating. See the Programming Your UC2000 chapter of this manual.
62. Program the UC2000 Control to Multi-cell mode "ON" or program the Fixed cell setting to the proper cell size for your battery. See the Programming Your UC2000 chapter of this manual.
63. Set the control PCB shunt size dip switch to match the shunt on the charger (1 leaf = 100A, 2 leaves = 200A, 4 leaves = 400A). Reset by pressing both Arrow keys simultaneously until the display resets.
64. Set the Control PCB cell size dip switches to match the charger nameplate cell size. Reset by pressing both Arrow keys simultaneously until the display resets.
65. Replace the ampere hour jumper with one that matches the nameplate AH rating of the charger. See the parts list included in this manual. Reset by pressing both Arrow keys simultaneously until the display resets.

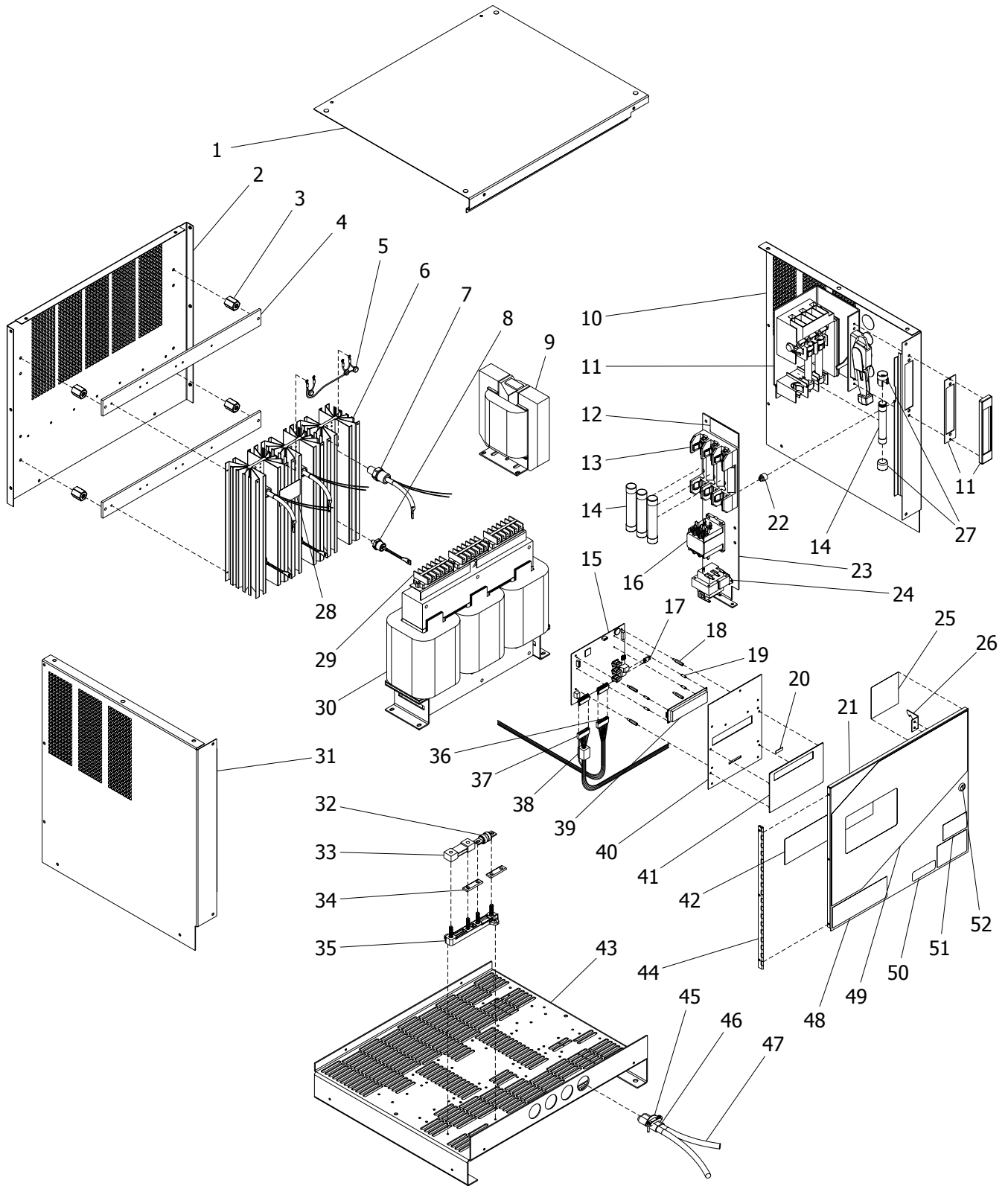

Figure 11-1 THREE PHASE

Parts List For Figure 11-1

Item No.	Item Description	PARTS COMMON TO THESE 3 PHASE MODELS	500363D-1	500134D-1	500135D-1	500136D-1	500137D-1
			500363D-2	500134D-2	500135D-2	500136D-2	500137D-2
			500363D-3	500134D-3	500135D-3	500136D-3	500137D-3
			500363D-6	500134D-5		500136D-4	500137D-4
						500136D-5	500137D-5
			500T3-12	750T3-12	1050T3-12	750T3-18	1050T3-18
1	Panel, Top (-1 thru -5 Spec only)	194376					
2	Panel, Top (-6 Spec only)	See Note 1					
3	Panel, Rear	194373					
	Panel, Rear (-6 Spec only)	196546					
	Insulator, Heat sink	404033					
4	Insulator, Heat sink	196222					
5	Capacitor, Ay.	194708					
6	Heat sink, Extruded		194392	194392	194391	194392	194391
7	Rectifier, Silicon Controlled		192112-1	192112-1	192113-1	192112-1	192113-1
8	Diode, Silicon, 150 A.	402832-3					
9	Choke		193676	192177	192178	191868	192179
10	Panel, Side, Right (-1, -3, -4 & -6 Spec only)	194521					
	Panel, Side, Right (-2 & -5 Spec only)	194375					
	Panel, Side, Right (-6 Spec only)	196562					
11	Switch, Disconnect (-2 Spec only)		403956-1	403956-1	403956-1	403956-2	403956-2
	Switch, Disconnect (-5 Spec only)		N/A	403956-1	N/A	403956-1	
12	Label, Input	196182					
13	Block, Fuse (-1 & -6 Spec only)		404605-4	404605-4	404605-4	404605-5	404605-5
	Block, Fuse (-3 Spec only)		404605-4	404605-4	404605-4	404605-4	404605-5
	Block, Fuse (-4 Spec only)		N/A	N/A	N/A	404605-4	404605-4
14	Fuse, AC Input (See Table 11-1)						
15	Board, PC, Control	196425-3					
16	Contact, 3 Pole	406243-1					
17	Connector, Amp-Hour		192302-1	192302-3	192302-1	192302-3	192302-1
18	Spacer, Hex, Threaded, Alum, 1"	192262-2					
19	Support, PC Board, Display	196603					
20	Label, Not For Telephone Use	196533					
21	Door, Hinged	196218					
22	Grommet, Mounting	194827-1					
23	Panel, Interior	194447					
24	Transformer, Control (208/240/480 Volt)	406247-2					
	Transformer, Control (240/480/575 Volt)	406247-4					
	Transformer, Control (400 Volt)	406247-3					
25	Label, AC Input (208/240/480 Volt)	406461					
	Label, AC Input (240/480/575 Volt)	194140					
26	Latch, Disconnect (-2 & -5 Spec only)	194379					
27	Reducer, Fuse (When Used - See Table 11-1)		N/A	N/A	N/A	196017	196017
28	Label, Warning	406518					
29	Block, Terminal	192273					
30	Transformer Assy. (-1, -2 & -6 Spec only)		196224	196545	196228	196230	196232
	Transformer Assy. (-3 & -5 Spec only)		196260	196262	196264	196266	196268
	Transformer Assy. (-4 Spec only)		N/A	N/A	N/A	196410	196404
31	Panel, Side, Left	194374					
32	Panel, Side, Left (-6 Spec only)	196561					
	Fuse, DC		Y1890-4	Y1890-5	Y1890-6	Y1890-5	Y1890-6
33	Shunt, Current		193125-2	193125-2	193125-3	193125-2	193125-3
34	Bus Bar	392458					
35	Insulator, Shunt	193114					
36	Harness, Wire, Rectifier	194808					
37	Harness, Wire, Interior Panel	194810					
38	Suppressor, Harness	192266-1					
39	Display, Vacuum Fluorescent	196611					
40	Panel, Control	196582					
41	Kit, Switch, Assy.	192306					
42	Label, Warning & Information	196183					
43	Base, Mounting	194372					
44	Hinge, Door	194377					
45	Connector, Strain Relief	W10080-5					
46	Cover, Neoprene	378234-13					
47	Cable, Output		396263-80	396263-81	396263-81	396263-81	396263-81
48	Label, Prestolite Power	196038					
49	Overlay, Door, Ultra Charge	196219					
50	Label, UL & CUL	404079					
51	Label, Disc. Sw. (-2 & -5 Spec only)	407250					
52	Latch, Door	194530					

Parts List For Figure 11-1 (Continued)

Item No.	Item Description	PARTS COMMON TO THESE 3 PHASE MODELS	500181D-1	500415D-1	500220D-1	500138D-1
			500181D-2	500415D-2	500220D-2	500138D-2
			500181D-3		500220D-3	500138D-3
			500181D-4			500138D-4
			500181D-5			
			1200T3-18	1400T3-18	650T3-24	750T3-24
1	Panel, Top (-1 thru -5 Spec only)	194376				
	Panel, Top (-6 Spec only)	See Note 1				
2	Panel, Rear	194373				
	Panel, Rear (-6 Spec only)	196546				
3	Insulator, Heat sink	404033				
4	Insulator, Heat sink	196222				
5	Capacitor, Ay.	194708				
6	Heat sink, Extruded		194391	194391	194392	194392
7	Rectifier, Silicon Controlled		192113-1	192113-1	192112-1	192112-1
8	Diode, Silicon, 150 A.	402832-3				
9	Choke		192179	196115	192180	192180
10	Panel, Side, Right (-1, -3 & -4 Spec only)	194521				
	Panel, Side, Right (-2 & -5 Spec only)	194375				
	Panel, Side, Right (-6 Spec only)	196562				
11	Switch, Disconnect (-2 & -5 Spec only)		403956-2	403956-2	403956-2	403956-2
12	Label, Input	196182				
13	Block, Fuse (-1 Spec only)		404605-5	404605-5	404605-5	404605-5
	Block, Fuse (-3 Spec only)		404605-5	N/A	404605-4	404605-5
	Block, Fuse (-4 Spec only)		404605-4	N/A	N/A	404605-4
14	Fuse, AC Input (See Table 11-1)					
15	Board, PC, Control	196425-3				
16	Contact, 3 Pole	406243-1				
17	Connector, Amp-Hour		192302-2	192302-8	192302-5	192302-3
18	Spacer, Hex, Threaded, Alum, 1"	192262-2				
19	Support, PC Board, Display	196603				
20	Label, Not For Telephone Use	196533				
21	Door, Hinged	196218				
22	Grommet, Mounting	194827-1				
23	Panel, Interior	194447				
24	Transformer, Control (208/240/480 Volt)	406247-2				
	Transformer, Control (240/480/575 Volt)	406247-4				
	Transformer, Control (400 Volt)	406247-3				
25	Label, AC Input (208/240/480 Volt)	406461				
	Label, AC Input (240/480/575 Volt)	194140				
26	Latch, Disconnect (-2 & -5 Spec only)	194379				
27	Reducer, Fuse (When Used - See Table 11-1)		196017	196017	196017	196017
28	Label, Warning	406518				
29	Block, Terminal	192273				
30	Transformer Assy. (-1 & -2 Spec only)		196234	196236	196238	196240
	Transformer Assy. (-3 & -5 Spec only)		196270	N/A	196274	196276
	Transformer Assy. (-4 Spec only)		196406	N/A	N/A	196412
31	Panel, Side, Left	194374				
	Panel, Side, Left (-6 Spec only)	196561				
32	Fuse, DC		Y1890-7	Y1890-8	Y1890-4	Y1890-5
33	Shunt, Current		193125-3	193125-3	193125-2	193125-2
34	Bus Bar	392458				
35	Insulator, Shunt	193114				
36	Harness, Wire, Rectifier	194808				
37	Harness, Wire, Interior Panel	194810				
38	Suppressor, Harness	192266-1				
39	Display, Vacuum Fluorescent	196611				
40	Panel, Control	196582				
41	Kit, Switch, Assy.	192306				
42	Label, Warning & Information	196183				
43	Base, Mounting	194372				
44	Hinge, Door	194377				
45	Connector, Strain Relief	W10080-5				
46	Cover, Neoprene	378234-13				
47	Cable, Output		396263-82	396263-82	396263-80	396263-81
48	Label, Prestolite Power	196038				
49	Overlay, Door, Ultra Charge	196219				
50	Label, UL & CUL	404079				
51	Label, Disc. Sw. (-2 & -5 Spec only)	407250				
52	Latch, Door	194530				

Parts List For Figure 11-1 (Continued)

Item No.	Item Description	PARTS COMMON TO THESE 3 PHASE MODELS	500139D-1	500261D-1	500184D-1	500161D-3	
			500139D-2	500261D-2	500184D-2		
			500139D-3	500261D-3	500184D-3		
			500139D-4	500261D-5	500184D-5	500161D-6	500161D-7
			1050T3-24	1200T3-24	550T3-40	850T3-40	
1	Panel, Top (w/o Opt.13 – Weather-Resistant Encl.)	194376					
2	Panel, Top (w/Opt.13 – Weather-Resistant Encl.)	See Note 1					
2	Panel, Rear	194373					
	Panel, Rear (with Opt. 13 only)	196546					
3	Insulator, Heat sink	404033					
4	Insulator, Heat sink	196222					
5	Capacitor, Ay.	194708					
6	Heat sink, Extruded		194391	194391	194392		194391
7	Rectifier, Silicon Controlled		192113-1	192113-1	192112-1		192113-1
8	Diode, Silicon, 150 A.	402832-3					
9	Choke		196109	196117	192615		196111
10	Panel, Side, Right (-1, -3, -4 & -6 Spec only)	194521					
	Panel, Side, Right (-2, -5 & -7 Spec only)	194375					
	Panel, Side, Right (with Opt.13 only)	196562					
11	Switch, Disconnect (-2, -5 & -7 Spec only)		403956-2	403956-2	403956-2		403956-2
12	Label, Input	196182					
13	Block, Fuse (-1, -3 & -6 Spec only)	404605-5					
	Block, Fuse (-4 Spec only)		404605-4	N/A	404605-5		N/A
14	Fuse, AC Input (See Table 11-1)						
15	Board, PC, Control	196425-3					
16	Contact, 3 Pole	406243-1					
17	Connector, Amp-Hour		192302-1	192302-2	192302-6		192302-4
18	Spacer, Hex, Threaded, Alum, 1"	192262-2					
19	Support, PC Board, Display	196603					
20	Label, Not For Telephone Use	196533					
21	Door, Hinged	196218					
22	Grommet, Mounting	194827-1					
23	Panel, Interior	194447					
24	Transformer, Control (208/240/480 Volt)	406247-2					
	Transformer, Control (240/480/575 Volt)	406247-4					
	Transformer, Control (400 Volt)	406247-3					
25	Label, AC Input (208/240/480 Volt)	406461					
	Label, AC Input (240/480/575 Volt)	194140					
26	Latch, Disconnect (-2, -5 & -7 Spec only)	194379					
27	Reducer, Fuse (When Used – See Table 11-1)		196017	196017	196017		196017
28	Label, Warning	406518					
29	Block, Terminal	192273					
30	Transformer Assy. (208/240/480 Volt)		196242	196631	196246		N/A
	Transformer Assy. (240/480/575 Volt)		196278	196280	196282		N/A
	Transformer Assy. (480/575 Volt)		N/A	N/A	N/A		196248
	Transformer Assy. (400 Volt) (-4 Spec only)		196408	N/A	N/A		N/A
31	Panel, Side, Left	194374					
32	Panel, Side, Left (with Opt.13 only)	196561					
	Fuse, DC		Y1890-6	Y1890-7	Y1890-4		Y1890-5
33	Shunt, Current		193125-3	193125-3	193125-2		193125-2
34	Bus Bar	392458					
35	Insulator, Shunt	193114					
36	Harness, Wire, Rectifier	194808					
37	Harness, Wire, Interior Panel	194810					
38	Suppressor, Harness	192266-1					
39	Display, Vacuum Fluorescent	196611					
40	Panel, Control	196582					
41	Kit, Switch, Assy.	192306					
42	Label, Warning & Information	196183					
43	Base, Mounting	194372					
44	Hinge, Door	194377					
45	Connector, Strain Relief	W10080-5					
46	Cover, Neoprene	378234-13					
47	Cable, Output		396263-81	396263-82	396263-80		396263-81
48	Label, Prestolite Power	196038					
49	Overlay, Door, Ultra Charge	196219					
50	Label, UL & CUL	404079					
51	Label, Disc. Sw. (-2, -5 & -7 Spec only)	407250					
52	Latch, Door	194530					

Fuses for Three-Phase Ultra Charge Units

Item No.	Item Description	500363D-1	500134D-1	500135D-1	500136D-1	500137D-1
		500363D-2	500134D-2	500135D-2	500136D-2	500137D-2
		500363D-3	500134D-3	500135D-3	500136D-3	500137D-3
			500134D-5		500136D-4	500137D-4
		500363D-6			500136D-5	500137D-5
		500T3-12	750T3-12	1050T3-12	750T3-18	1050T3-18
14	Fuse, AC Input (208 V.) (-1, -2 & -6 Spec only)	196030-15	196030-25	196030-30	196030-35	196030-45
	Fuse, AC Input (240 V.) (-1, -2 & -6 Spec only)	196030-12	196030-20	196030-25	196030-30 *	196030-40
	Fuse, AC Input (240 V.) (-3 & -5 Spec only)	196030-12	196030-20	196030-25	196030-30	196030-40
	Fuse, AC Input (400 V.) (-4 Spec only)	N/A	N/A	N/A	196030-20	196030-25
	Fuse, AC Input (480 V.) (-1, -2 & -6 Spec only)	196030-6	196030-10	196030-12	196030-15 *	196030-20 *
	Fuse, AC Input (480 V.) (-3 & -5 Spec only)	196030-6	196030-10	196030-12	196030-15	196030-20 *
	Fuse, AC Input (575 V.) (-3 & -5 Spec only)	196030-5	196030-10	196030-12	196030-12	196030-15 *
	* Requires Item #27, 1 pair per fuse.					

Item No.	Item Description	500181D-1	500415D-1	500220D-1	500138D-1	
		500181D-2	500415D-2	500220D-2	500138D-2	
		500181D-3		500220D-3	500138D-3	
		500181D-4			500138D-4	
		500181D-5				
		1200T3-18	1400T3-18	650T3-24	750T3-24	
14	Fuse, AC Input (208 V.) (-1 & -2 Spec only)	196030-60	196030-60	196030-35	196030-45	
	Fuse, AC Input (240 V.) (-1 & -2 Spec only)	196030-45	196030-50	196030-30 *	196030-40	
	Fuse, AC Input (240 V.) (-3 & -5 Spec only)	196030-45	N/A	196030-30	196030-40	
	Fuse, AC Input (400 V.) (-4 Spec only)	196030-25	N/A	N/A	196030-25	
	Fuse, AC Input (480 V.) (-1 & -2 Spec only)	196030-25 *	196030-25 *	196030-15 *	196030-20 *	
	Fuse, AC Input (480 V.) (-3 & -5 Spec only)	196030-25 *	N/A	196030-15	196030-20 *	
	Fuse, AC Input (575 V.) (-3 & -5 Spec only)	196030-20 *	N/A	196030-15	196030-15 *	
	* Requires Item #27, 1 pair per fuse.					

Item No.	Item Description	500139D-1	500261D-1	500184D-1	
		500139D-2	500261D-2	500184D-2	
		500139D-3	500261D-3	500184D-3	500161D-3
		500139D-4			
			500261D-5	500184D-5	500161D-6
				500184D-6	500161D-7
		1050T3-24	1200T3-24	550T3-40	850T3-40
14	Fuse, AC Input (208 V.) (-1 & -2 Spec only)	196030-60	196030-60	196030-60	N/A
	Fuse, AC Input (208 V.) (-5 & -6 Spec only)	N/A	N/A	196030-60	N/A
	Fuse, AC Input (240 V.) (-1, -2, -3, -5 & -6 Spec)	196030-60	196030-60	196030-50	N/A
	Fuse, AC Input (400 V.) (-4 Spec only)	196030-30	N/A	N/A	N/A
	Fuse, AC Input (480 V.) (-1,-2,-3,-5,-6 & -7 Spec)	196030-30 *	196030-30 *	196030-25 *	196030-40
	Fuse, AC Input (575 V.) (-3, -5, -6 & -7 Spec only)	196030-20 *	196030-20 *	196030-20 *	196030-30 *
	* Requires Item #27, 1 pair per fuse.				

Note 1: For chargers with weather-resistant enclosures (Opt. 13), in place of a Top Panel (Item 1) the following parts are used:

Canopy	195040
Support, Rear, Canopy	195064
Support, Side, Canopy	195065
Support, Front, Canopy	195063

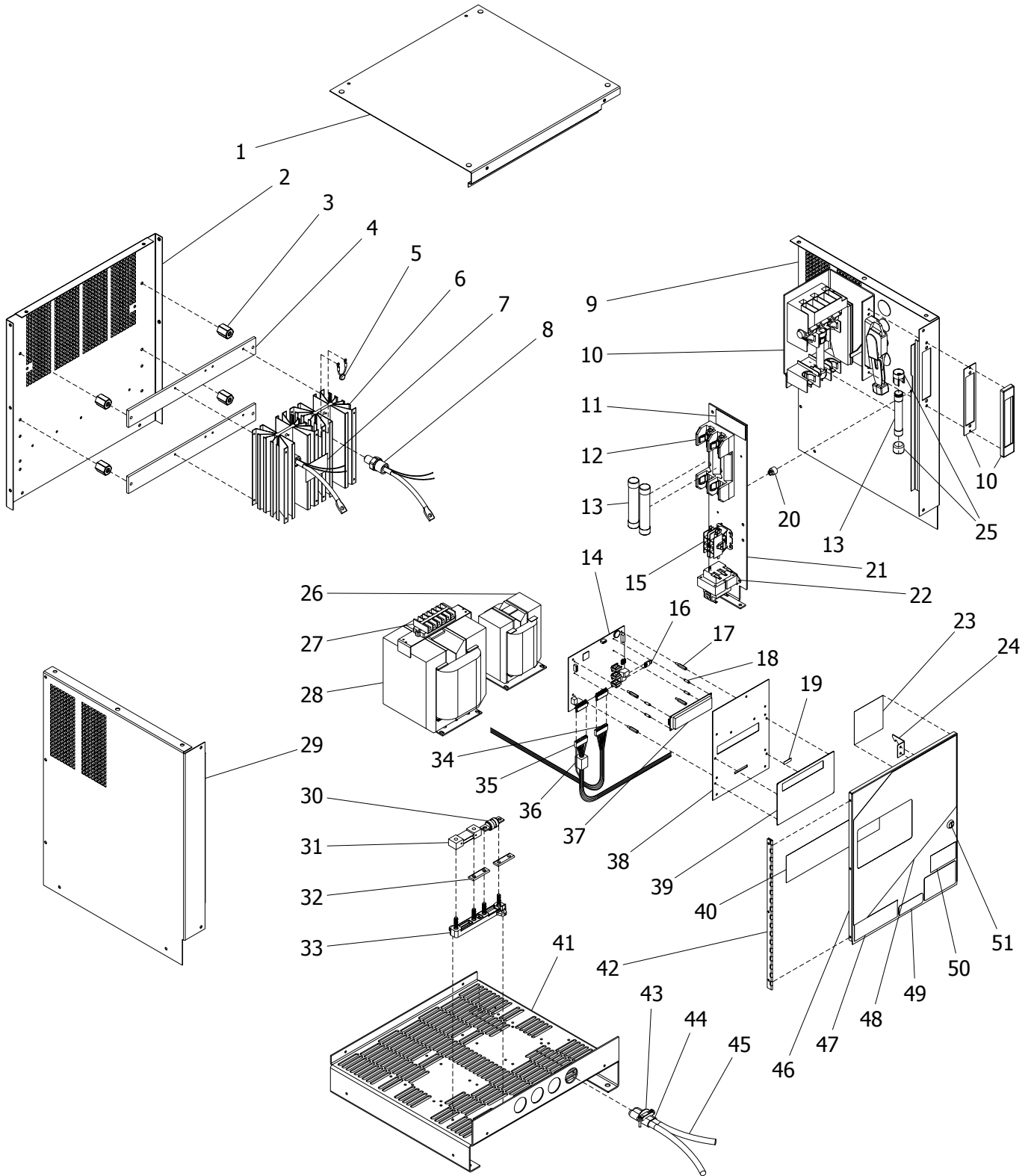

Figure 11-2 Single Phase

Parts List For Figure 11-2

Item No.	Item Description	PARTS COMMON TO THESE 3 PHASE MODELS	500362D-1	500130D-1	500131D-1	500132D-1	500133D-1
			500362D-2	500130D-2	500131D-2	500132D-2	500133D-2
			300S1-12	500S1-12	750S1-12	600S1-18	500S1-24
1	Panel, Top	194457					
2	Panel, Rear	194454					
3	Insulator, Heat sink	404033					
4	Insulator, Heat sink	196320					
5	Capacitor, Ay.	193223-2					
6	Heat sink, Extruded	192224					
7	Label, Warning	406518					
8	Rectifier, Silicon Controlled		192112-1	192112-1	192113-1	192112-1	192112-1
9	Panel, Side, Right (-1 & -4 Spec only) Panel, Side, Right (-2 & -5 Spec only)	194565 194456					
10	Switch, Disconnect (-2 & -5 Spec only)		403956-1	403956-1	403956-2	403956-2	403956-2
11	Label, Input	196182					
12	Block, Fuse (-1 & -4 Spec only)		404605-4	404605-4	404605-5	404605-5	404605-5
13	Fuse, AC Input (208 V.) (-1 & -2 Spec only) Fuse, AC Input (220 V.) (-4 Spec only) Fuse, AC Input (240 V.) (-1, -2 & -5 Spec only) Fuse, AC Input (380 V.) (-4 Spec only) Fuse, AC Input (415 V.) (-4 Spec only) Fuse, AC Input (480 V.) (-1, -2 & -5 Spec only) Fuse, AC Input (575 V.) (-5 Spec only) * Requires Item #25, 1 pair per fuse.		196030-20 N/A 196030-15 N/A N/A 196030-8 N/A	196030-30 196030-25 196030-25 196030-15 196030-15 196030-15 N/A	196030-45 196030-40 196030-40 196030-20 * 196030-20 * 196030-20 * 196030-15 *	196030-50 196030-50 196030-45 196030-25 * 196030-25 * 196030-25 * N/A	196030-60 196030-50 196030-50 196030-30 * 196030-25 * 196030-25 * N/A
14	Board, PC, Control	196425-3					
15	Contact, 2 Pole		406240-1	406240-1	406241-1	406241-1	406241-1
16	Connector, Amp-Hour		192302-2	192302-1	192302-3	192302-2	192302-1
17	Spacer, Hex, Threaded, Alum, 1"	192262-2					
18	Support, PC Board, Display	196603					
19	Label, Not For Telephone Use	196533					
20	Grommet, Mounting	194827-1					
21	Panel, Interior	194447					
22	Transformer, Control (-1 & -2 Spec only) Transformer, Control (-5 Spec only) Transformer, Control (-4 Spec only)	406247-2 406247-4 406247-3					
23	Label, AC Input (-1 & -2 Spec only) Label, AC Input (-5 Spec only) Label, AC Input (-4 Spec only)	406461 406365 406928					
24	Latch, Disconnect (-2 & -5 Spec only)	194379					
25	Reducer, Fuse (When Used - See Table 11-2)		N/A	N/A	196017	196017	196017
26	Choke		193657	192162	192163	192175	192176
27	Block, Terminal	192273					
28	Transformer Assy. (-1 & -2 Spec only) Transformer Assy. (-5 Spec only) Transformer Assy. (-4 Spec only)		193655 N/A N/A	192170A N/A 192170A	192171A 196200 192171A	192172A N/A 192172A	192173A N/A 192173A
29	Panel, Side, Left	194455					
30	Fuse, DC		Y1890-3	Y1890-3	Y1890-5	Y1890-4	Y1890-4
31	Shunt, Current		193125-1	193125-1	193125-2	193125-2	193125-2
32	Bus Bar	392458					
33	Insulator, Shunt	193114					
34	Harness, Wire, Rectifier	196696					
35	Harness, Wire, Interior Panel	194810					
36	Suppressor, Harness	192266-1					
37	Display, Vacuum Fluorescent	196611					
38	Panel, Control	196582					
39	Kit, Switch, Assy.	192306					
40	Label, Warning & Information	196183					
41	Base, Mounting	194453					
42	Hinge, Door	194377					
43	Connector, Strain Relief	W10080-5					
44	Cover, Neoprene	378234-13					
45	Cable, Output		396263-1	396263-2	396263-4	396263-2	396263-2
46	Door, Hinged	196189					
47	Label, Prestolite Power	196036					
48	Overlay, Door, Ultra Charge	196191					
49	Label, UL & CUL	404079					
50	Label, Disc. Sw. (-2 & -5 Spec only)	407250					
51	Latch, Door	194530					

DIAGRAMS

INPUT VOLTAGE	DIAGRAMS		DIMENSIONAL OUTLINE
	1 PHASE	3 PHASE	
208/240/480	196695	196675	196377
240/480/575	196695	196675	196377
480/575	N/A	196675	196377
220/380/415	196695	N/A	196377
400	N/A	196677	196377

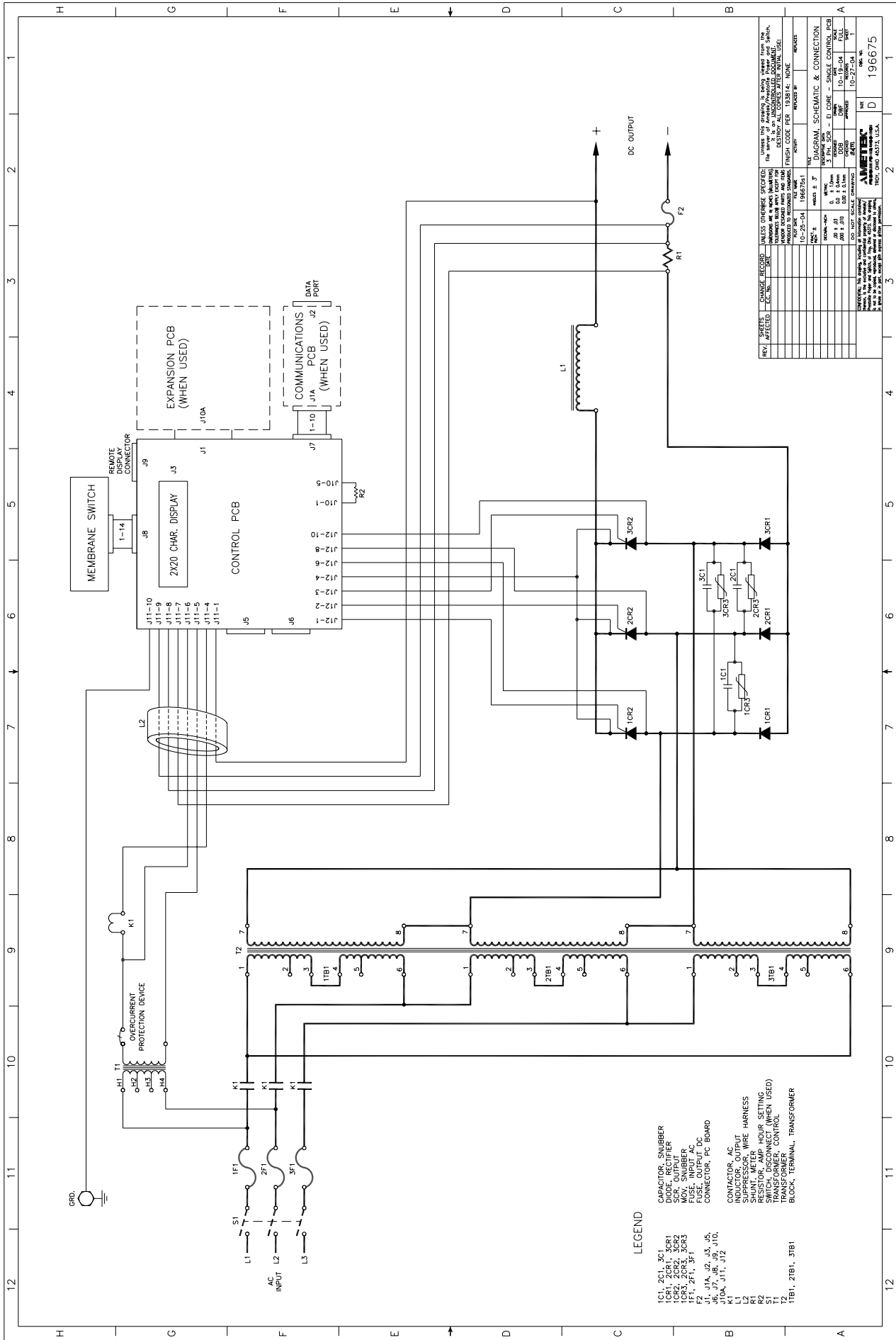

LEGEND

- 1C1, 2C1, 3C1 CAPACITOR, SNUBBER
- 1CR1, 1CR2, 2CR1, 2CR2, 3CR1, 3CR2 SCR, OUTPUT
- 1CR3, 2CR3, 3CR3 MOV. SNUBBER
- 1F1, 2F1, 3F1 FUSE, OUTPUT DC
- J1, J1A, J2, J3, J5, J6, J7, J8, J9, J10, J11, J12 CONNECTOR, PC BOARD
- K1 CONTACTOR, AC
- L1 INDUCTOR, OUTPUT
- R1 SHUNT, METER
- R2 RESISTOR, AMP HOUR SETTING
- T1 TRANSFORMER, CONTROL
- T2 TRANSFORMER, POWER
- 2TB1, 2TB2, 3TB1 BLOCK, TERMINAL, TRANSFORMER

REV.	APPROVED	CHANGE	REASON	DATE	BY	CHKD.	DATE	BY	REV.

REV.	APPROVED	CHANGE	REASON	DATE	BY	CHKD.	DATE	BY

UNLESS OTHERWISE SPECIFIED, THE MANUFACTURER'S STANDARD SPECIFICATIONS SHALL APPLY TO ALL MATERIALS AND COMPONENTS. THE MANUFACTURER'S STANDARD SPECIFICATIONS SHALL BE OBTAINED FROM THE MANUFACTURER'S LITERATURE.

FINISH CODE PER 1932B 14 - NONE

DATE: 10-27-04

REV: 1

196675

AMETEK
 AMETEK ELECTRONICS, INC.
 10000 W. 11TH AVE., SUITE 200
 DENVER, CO 80233-4500
 U.S.A.

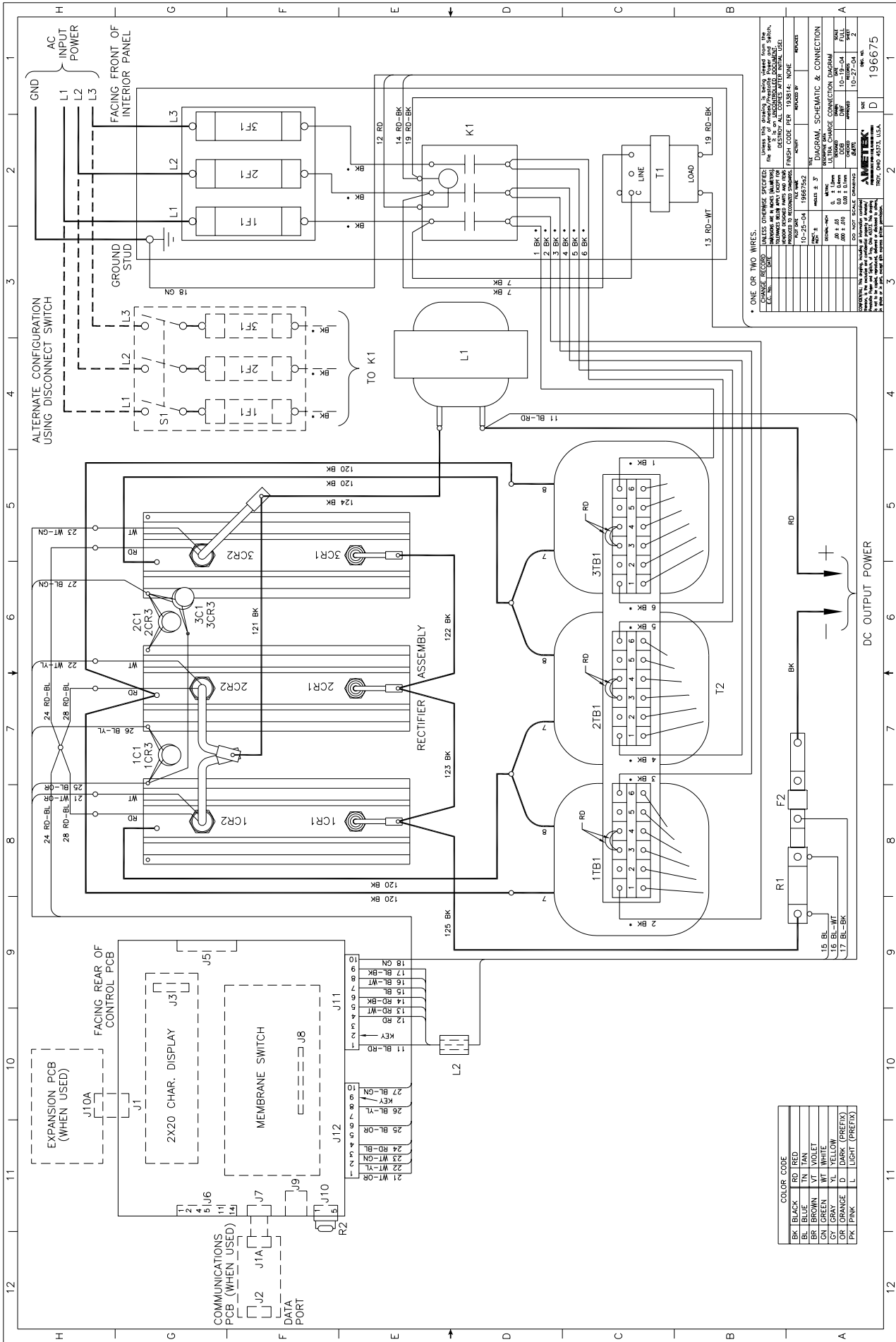

UNLESS OTHERWISE SPECIFIED, ALL DIMENSIONS ARE IN INCHES. DIMENSIONS IN PARENTHESES ARE FOR REFERENCE ONLY. DIMENSIONS IN BRACKETS ARE FOR INFORMATION ONLY. DIMENSIONS IN PARENTHESES ARE FOR INFORMATION ONLY. DIMENSIONS IN PARENTHESES ARE FOR INFORMATION ONLY.

DATE	10-27-04	REVISED BY	
DESCRIPTION	1967/252	REVISED BY	
DATE	10-25-04	REVISED BY	
DESCRIPTION	1967/252	REVISED BY	
DATE	10-19-04	REVISED BY	
DESCRIPTION	1967/252	REVISED BY	
DATE	10-13-04	REVISED BY	
DESCRIPTION	1967/252	REVISED BY	
DATE	10-07-04	REVISED BY	
DESCRIPTION	1967/252	REVISED BY	

DIAGRAM, SCHEMATIC & CONNECTION
 L1 TBX CHANGE CONNECTION DIAGRAM
 T1 TBX CHANGE CONNECTION DIAGRAM
 C LINE TBX CHANGE CONNECTION DIAGRAM
 LOAD TBX CHANGE CONNECTION DIAGRAM

1967/252

AMETEK
 1967/252

196675

COLOR CODE			
BK	BLACK	RD	RED
BL	BLUE	TN	TAN
GN	GREEN	WT	WHITE
GY	GRAY	YL	YELLOW
OR	ORANGE	D	DARK (PREFIX)
PK	PINK	L	LIGHT (PREFIX)

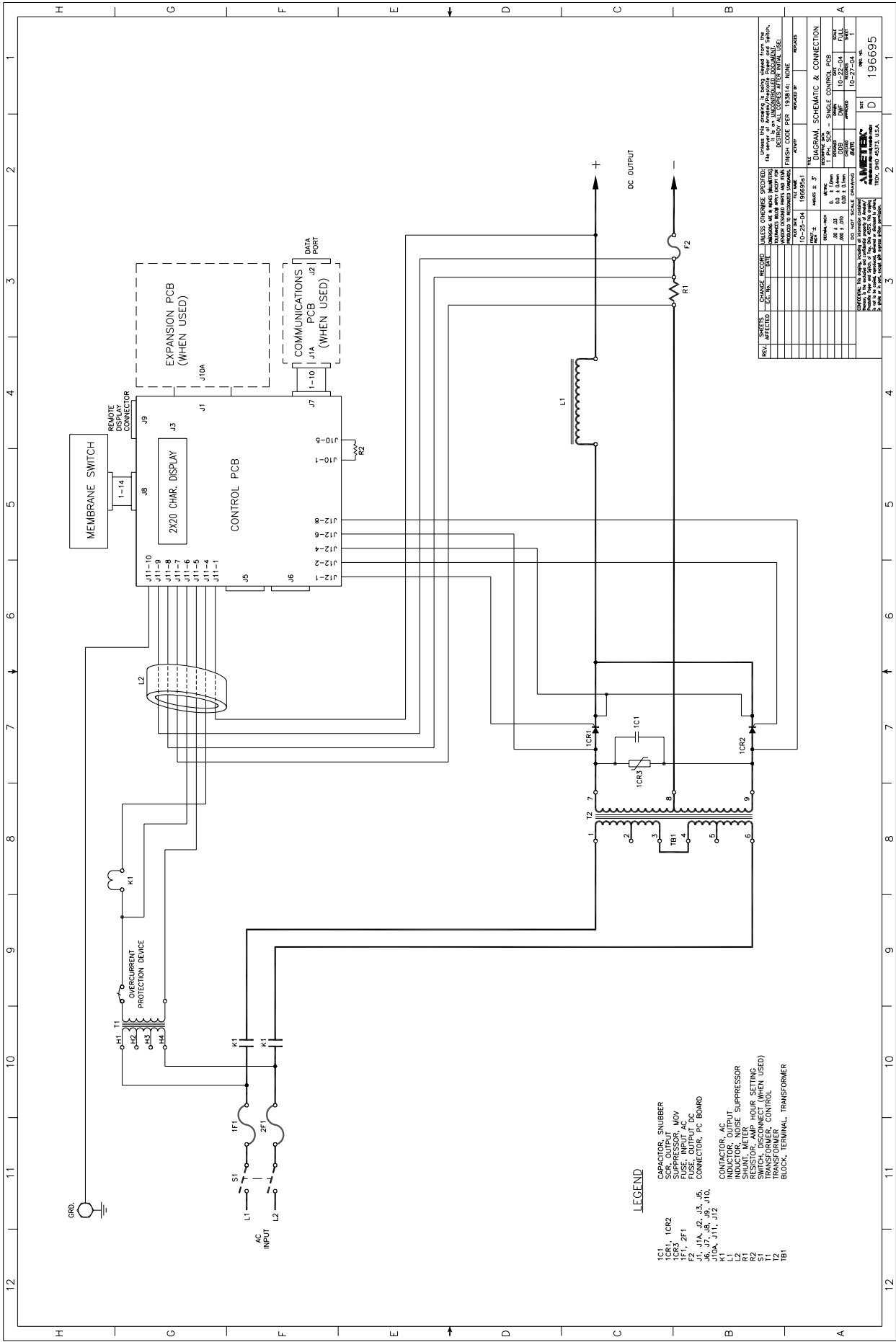

REV.	DATE	DESCRIPTION	BY	CHK.
1	10-22-04	ISSUED FOR PRODUCTION		
2	10-22-04	REVISED TO ADD COMMUNICATIONS PCB		
3	10-22-04	REVISED TO ADD EXPANSION PCB		
4	10-22-04	REVISED TO ADD REMOTE DISPLAY CONNECTOR		
5	10-22-04	REVISED TO ADD DATA PORT		
6	10-22-04	REVISED TO ADD MEMBRANE SWITCH		
7	10-22-04	REVISED TO ADD 2X20 CHARACTER DISPLAY		
8	10-22-04	REVISED TO ADD SHUNT METER		
9	10-22-04	REVISED TO ADD OVERCURRENT PROTECTION DEVICE		
10	10-22-04	REVISED TO ADD AC INPUT FUSE AND SHUNT METER		
11	10-22-04	REVISED TO ADD TRANSFORMER		
12	10-22-04	REVISED TO ADD DC OUTPUT FUSE		

REV.	DATE	DESCRIPTION	BY	CHK.
1	10-22-04	ISSUED FOR PRODUCTION		
2	10-22-04	REVISED TO ADD COMMUNICATIONS PCB		
3	10-22-04	REVISED TO ADD EXPANSION PCB		
4	10-22-04	REVISED TO ADD REMOTE DISPLAY CONNECTOR		
5	10-22-04	REVISED TO ADD DATA PORT		
6	10-22-04	REVISED TO ADD MEMBRANE SWITCH		
7	10-22-04	REVISED TO ADD 2X20 CHARACTER DISPLAY		
8	10-22-04	REVISED TO ADD SHUNT METER		
9	10-22-04	REVISED TO ADD OVERCURRENT PROTECTION DEVICE		
10	10-22-04	REVISED TO ADD AC INPUT FUSE AND SHUNT METER		
11	10-22-04	REVISED TO ADD TRANSFORMER		
12	10-22-04	REVISED TO ADD DC OUTPUT FUSE		

AMETEK
 196695-1
 10-22-04

LEGEND

- 1CR1, 1CR2 DIODES
- 1CR3 CAPACITOR, SNUBBER
- C1 CAPACITOR, OUTPUT FILTER
- F1, F2 FUSES
- J1, J1A, J1B, J1C, J1D, J1E, J1F, J1G, J1H, J1I, J1J CONNECTORS, PC BOARD
- K1 CONTACTOR, AC
- L1 INDUCTOR, OUTPUT
- S2 SHUNT, METER
- T1 TRANSFORMER, CONTROL BOARD
- TB1 TERMINAL BOARD

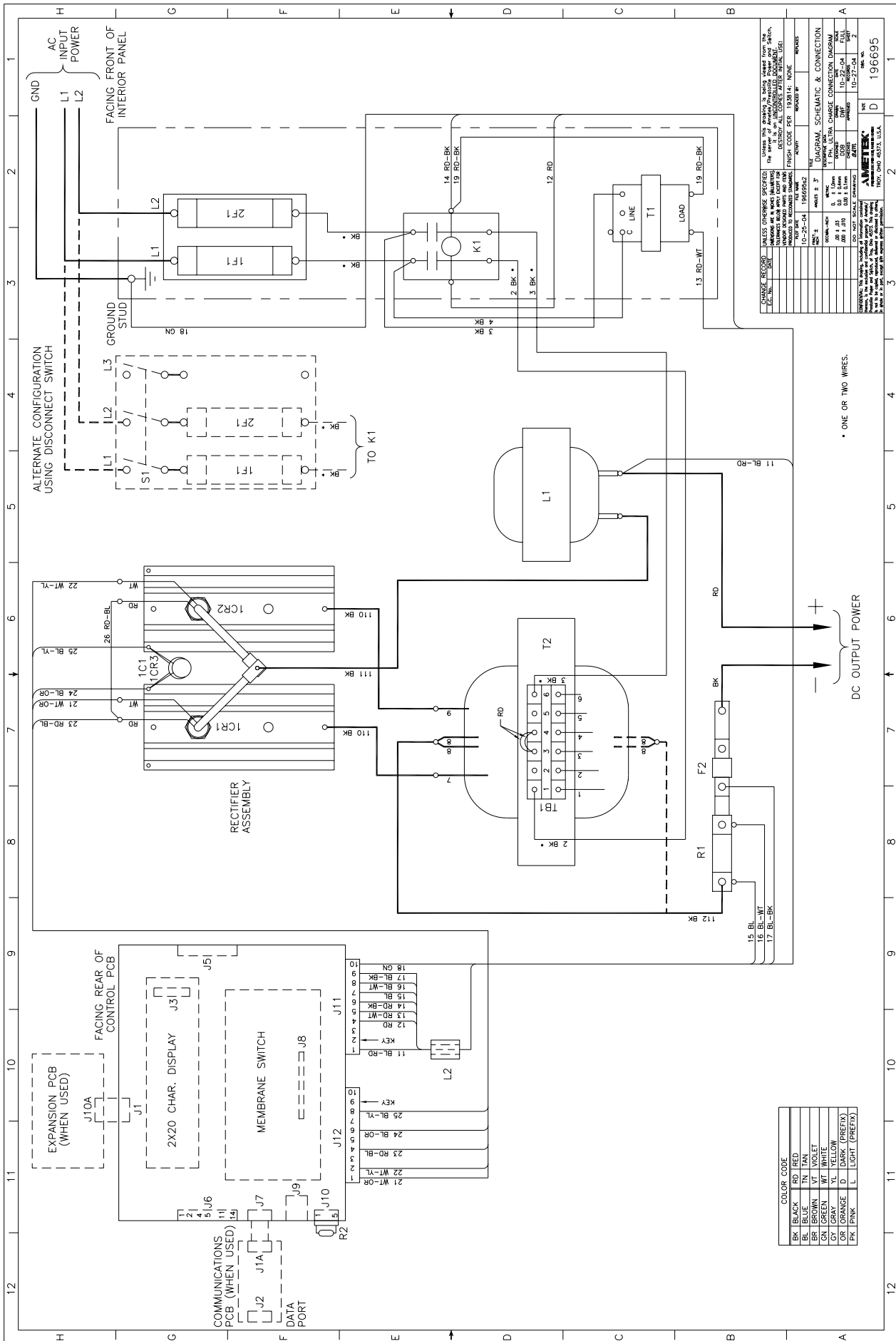

THIS SCHEMATIC IS THE PROPERTY OF THE COMPANY AND IS NOT TO BE REPRODUCED OR TRANSMITTED IN ANY FORM OR BY ANY MEANS, ELECTRONIC OR MECHANICAL, INCLUDING PHOTOCOPYING, RECORDING, OR BY ANY INFORMATION STORAGE AND RETRIEVAL SYSTEM. FINISH CODE PER 193814: NONE. DESTROY ALL COPIES AFTER FINAL USE.

DATE REVISION	BY	REASON
10-25-04	1966952	REWORK

DRAWING NO. 1966952
 PROJECT NO. 10-25-04
 SHEET NO. 2 OF 2
 TITLE: POWER SUPPLY SCHEMATIC & CONNECTION

APPROVED BY: [Signature]
 DESIGNED BY: [Signature]

COMPANY: TRIP, OHIO 45153, U.S.A.

COLOR	CODE
BK	BLACK
BL	BLUE
BR	BROWN
GN	GREEN
GR	GRAY
OR	ORANGE
PK	PINK
RD	RED
TN	TAN
VT	VIOLET
WT	WHITE
YL	YELLOW
GRN	GREEN
LGHT	LIGHT

* ONE OR TWO WIRES.

DC OUTPUT POWER

ALTERNATE CONFIGURATION USING DISCONNECT SWITCH

FACING REAR OF CONTROL PCB

FACING FRONT OF INTERIOR PANEL

1 2 3 4 5 6 7 8 9 10 11 12
 H G F E D C B A

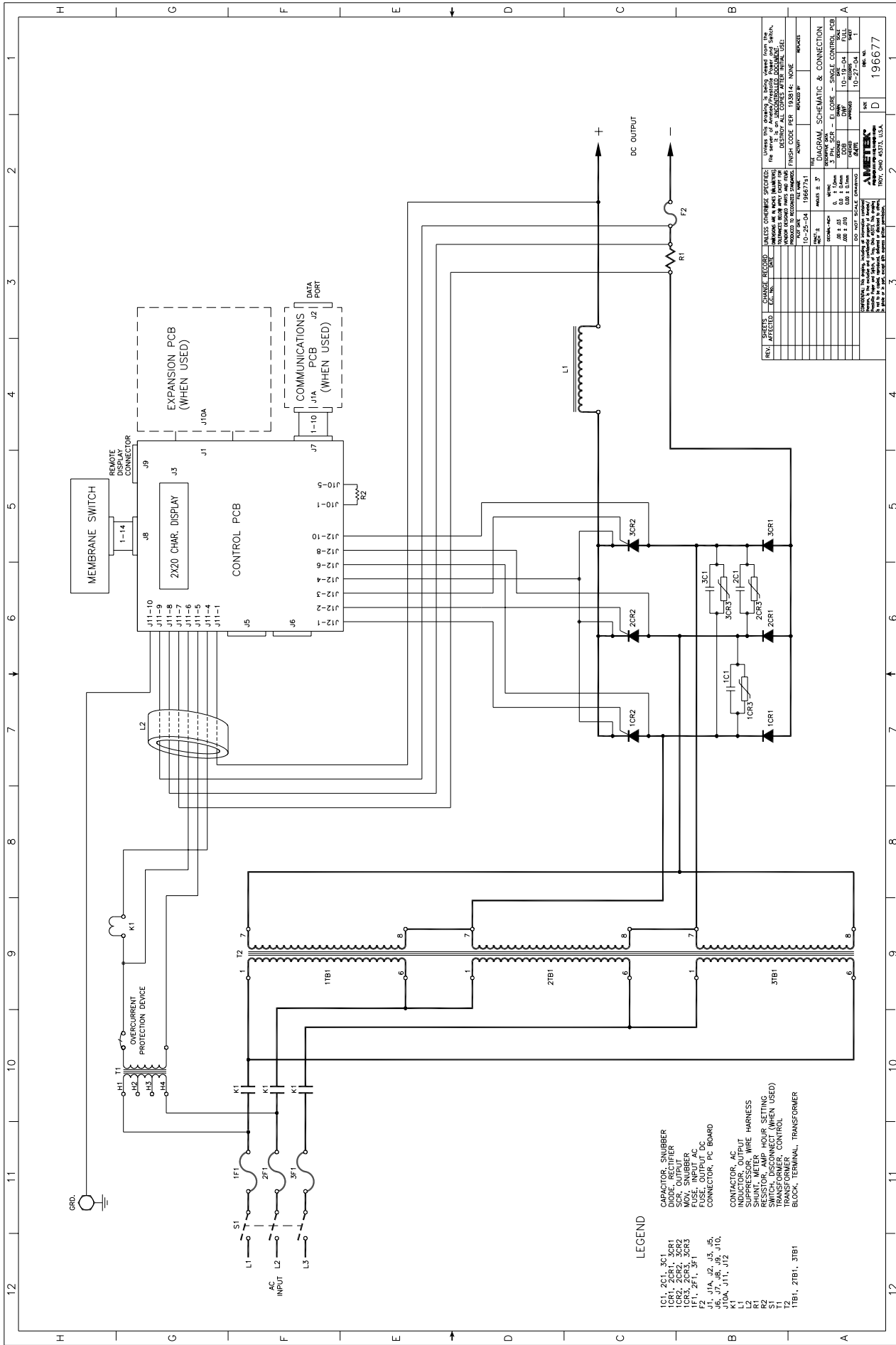

LEGEND

- 1C1, 2C1, 3C1 CAPACITOR, SNUBBER
- 1CR1, 2CR1, 3CR1, 4CR1 SCR, OUTPUT DIODE
- 1CR2, 2CR2, 3CR2 MOV, SNUBBER
- 1CR3, 2CR3, 3CR3 FUSE, OUTPUT DC
- F2 FUSE, OUTPUT DC
- J1, J1A, J2, J3, J5, J6, J10A, J11, J12 CONNECTOR, PC BOARD
- K1 CONTACTOR, AC
- L1, L2 SUPPRESSOR, WIRE HARNESS
- R1 SHUNT, METER
- S1, S2 SWITCH, DISCONNECT (WHEN USED)
- T1 TRANSFORMER, CONTROL
- 1TB1, 2TB1, 3TB1 BLOCK, TERMINAL, TRANSFORMER

REV.	DATE	DESCRIPTION	BY	CHKD.	APP'D.
1	10-25-54	196675.1			
2	10-25-54	196675.1			

REV.	DATE	DESCRIPTION	BY	CHKD.	APP'D.
1	10-27-54	196675.1			
2	10-27-54	196675.1			

REV.	DATE	DESCRIPTION	BY	CHKD.	APP'D.
1	10-27-54	196675.1			
2	10-27-54	196675.1			

196677

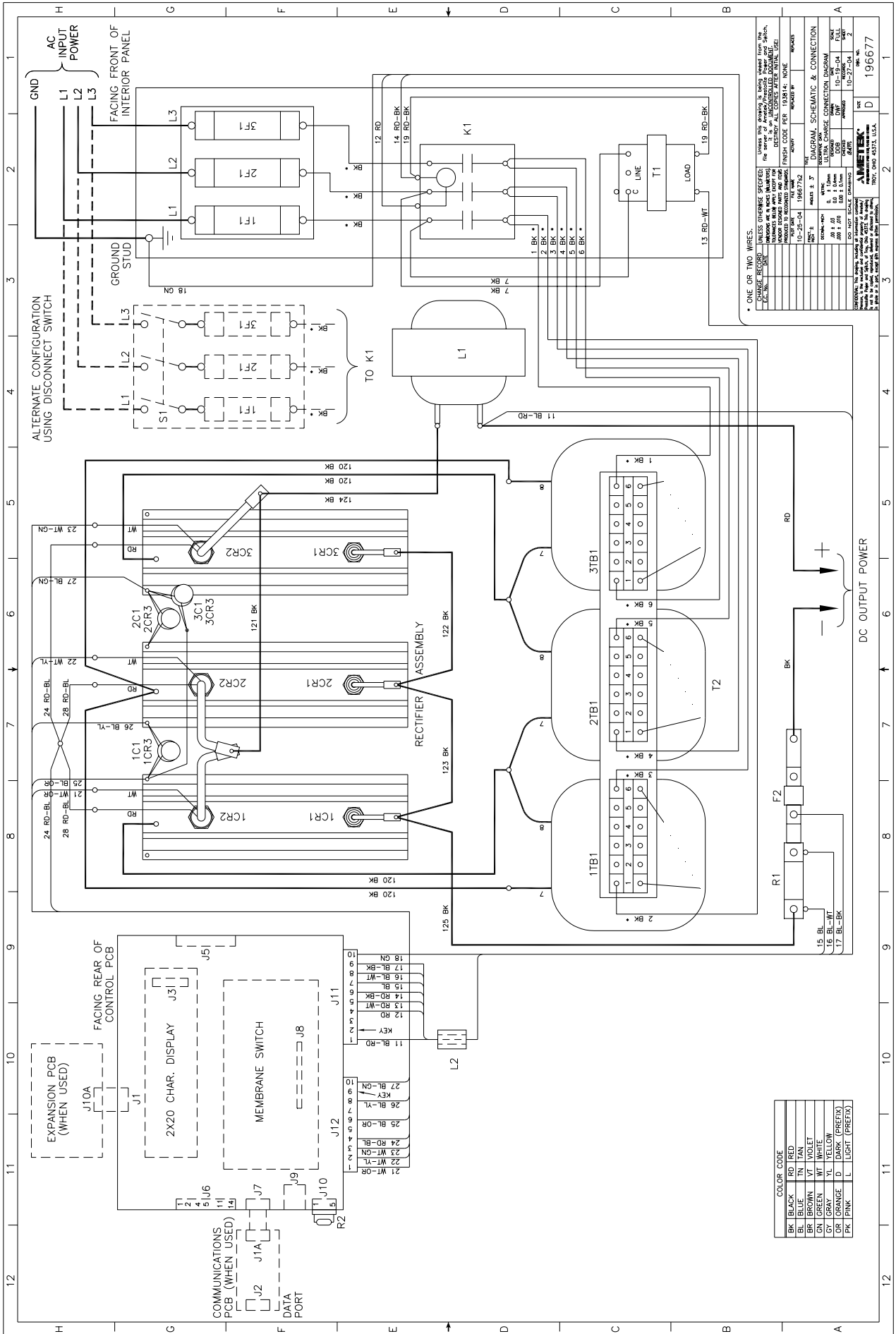

UNLESS OTHERWISE SPECIFIED: ALL DIMENSIONS ARE IN MILLIMETERS (INCHES) UNLESS OTHERWISE SPECIFIED. FINISH CODE PER 1928B-14, NONE.

WIRE	GAUGE	INSULATION	FINISH CODE	FINISH CODE PER 1928B-14, NONE
1 BK	18	PVC		
2 BK	18	PVC		
3 BK	18	PVC		
4 BK	18	PVC		
5 BK	18	PVC		
6 BK	18	PVC		

• ONE OR TWO WIRES.

COLOR CODE	WIRE
BK	BLACK
BL	BLUE
BR	BROWN
GN	GREEN
GR	GRAY
OR	ORANGE
PK	PINK
RD	RED
TN	TAN
VT	VIOLET
WT	WHITE
YL	YELLOW
DR	DARK (PREFIX)
LT	LIGHT (PREFIX)

196677

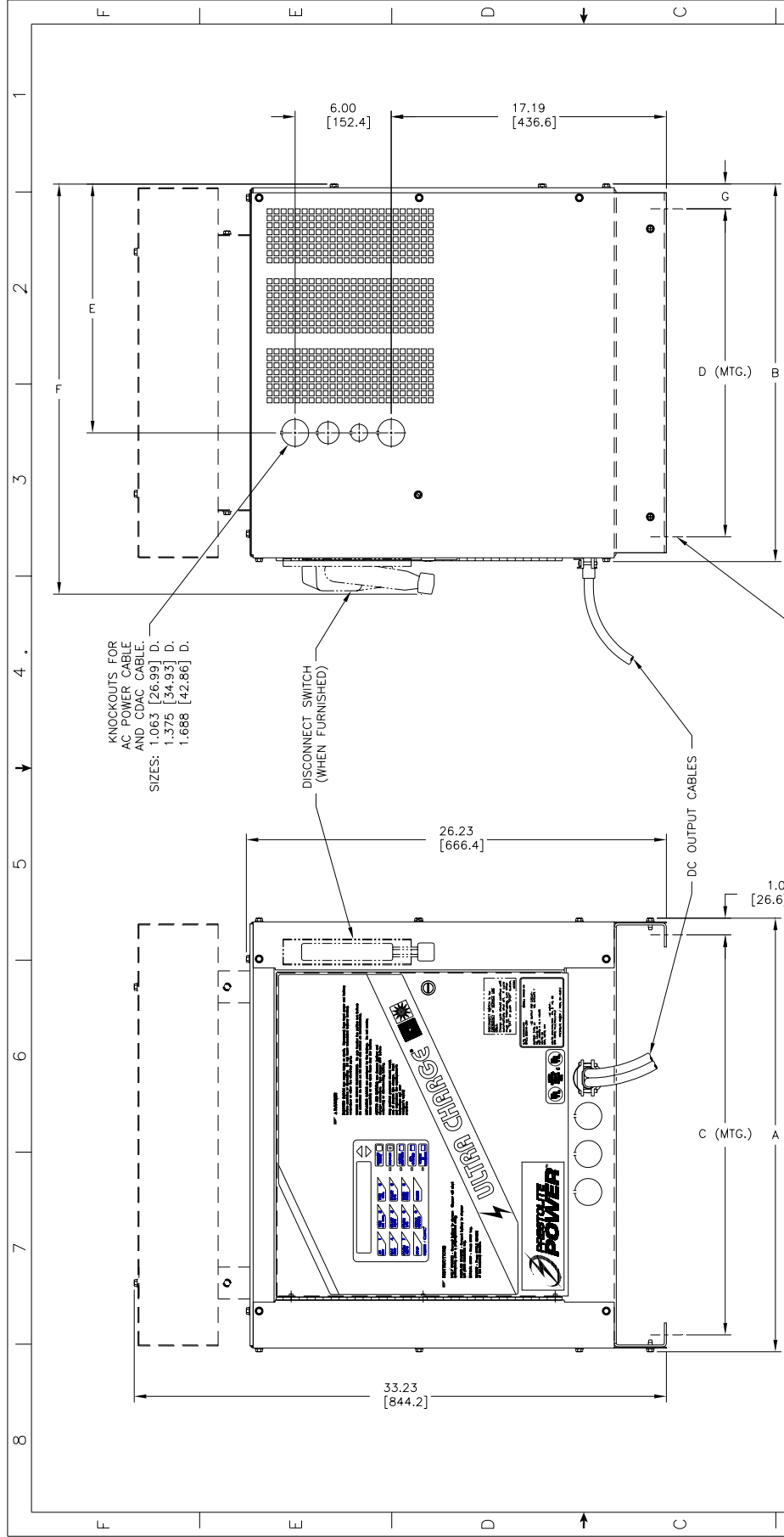

DIMENSIONS ARE SPECIFIED AS:
 INCHES
 [MILLIMETERS]

CHANGE RECORD	FILE NAME	PILOT DATE	FINISH CODE PER	REPLACED BY
	196377	4-25-03	193814	NONE
E.C. NO.			ACTIVITY	
			MATERIAL NO.	
			QUANTITY-UM.	
			COMM. CLK.	

CABINET DESIGNATION (CASE)	DIMENSIONS							REMARKS
	A (WIDTH)	B (DEPTH)	C (MTG.)	D (MTG.)	E (KO'S)	F (DISC. SW.)	G (MTG.)	
S	21.47 [545.3]	20.47 [519.5]	19.38 [492.1]	17.75 [450.9]	12.54 [318.5]	22.50 [571.5]	1.36 [34.5]	
T	27.09 [686.2]	23.59 [599.3]	25.00 [635.0]	20.50 [520.7]	15.54 [394.7]	25.63 [650.9]	1.55 [39.4]	T CASE SHOWN

TITLE: OUTLINE, DIMENSIONAL				
S & T CASE				
DRAWN	CHECKED	APPROVED	DATE	SCALE
			4-03-03	CUSTOMER
				REVISION
				4-25-03
				SIZE
				ONE NO. SHEET 1 OF 1
				C
				196377
CONFIDENTIAL: This drawing, including all information contained hereon, is the property of AMMETEK, Inc. and is not to be copied, reproduced, delivered or disposed of above, in whole or in part, without the prior written consent of AMMETEK, Inc.				
AMMETEK TROY, OHIO 45373, U.S.A.				



WARRANTY

AMETEK/PRESTOLITE POWER “SCR” INDUSTRIAL BATTERY CHARGERS

Ametek/Prestolite Power (hereinafter called “Prestolite”) warrants that each new and unused Industrial Battery Charger manufactured and supplied by it is of good workmanship and is free from any inherent mechanical defects, provided that (1) the product is installed and operated in accordance with generally accepted industrial standards and in accordance with the printed instructions of Prestolite, (2) the product is used under normal conditions for which designed, (3) the product is not subjected to misuse, negligence or accident, and (4) the product receives proper care, protection and maintenance under supervision of competent personnel. This warranty is subject to the following provisions:

1. **PRODUCT AND PARTS WARRANTED.** Subject to the exceptions listed below each Industrial Battery Charger is warranted for a specific period of time commencing from the date of it’s shipment by Prestolite, provided the charger is used in accordance with Prestolite’s published performance rating for the unit involved. The exceptions to this warranty are as follows:

a) Terms and conditions for warranty coverage:

<u>SCR PRODUCTS</u>	ULTRA MAXX	ULTRA CHARGE	POWER STAR	POWERSTAR PLUS
FULL COVERAGE - LABOR, TRAVEL, MILEAGE & PART REPLACEMENT	1-year	1-year	1-year	1-year
PRINTED CIRCUIT BOARD (REPLACEMENT ONLY)	2-years additional	2-years additional	2-years additional	2-years additional
TRANSFORMER, INDUCTOR, SCR & DIODE (REPLACEMENT ONLY)	9-years additional	9-years additional	9-years additional	9-years additional
TOTAL WARRANTY TERM (YEARS)	10-years	10-years	10-years	10-years

b) Warranty Expense Limitation: The maximum warranty expense Prestolite will incur for any Battery Charger will be limited to the original purchase price of the Battery Charger.

c) Primary switch contacts, fuses, bulbs and filters are not warranted unless found to be defective prior to use.

2. **COMMENCEMENT OF WARRANTY TIME PERIODS.** The warranty periods indicated in the Warranty Schedule shall commence on the date of shipment by Prestolite.
3. **PERSONS COVERED BY WARRANTY.** Prestolite extends this warranty only to the purchaser of new equipment from Prestolite or one of its authorized distributors. The products purchased under this agreement shall be used exclusively by the buyer and its employees and by no other persons; and therefore there shall be no third party beneficiary to this warranty.
4. **LIMITATION OF REMEDY.** The existence of claimed defects in any product covered by this warranty is subject to Prestolite’s factory inspection and judgement. Prestolite’s liability is limited to repair of any defects found by Prestolite to exist or, at Prestolite’s option, the replacement of the defective product F.O.B. factory after the defective product has been returned by the purchaser at its expense to Prestolite’s shipping place. Replacement and exchange parts will be warranted for the remainder of the original Industrial Battery Charger Warranty or for a period of ninety (90) days, whichever is greater.
5. **USE OF DEFECTIVE PRODUCT.** Continued use of an Industrial Battery Charger after discovery of a defect **VOIDS ALL WARRANTIES.**
6. **ALTERED EQUIPMENT.** Except as authorized in writing, the warranty specified does not cover any equipment that has been altered by any party other than Prestolite.

THIS WARRANTY IS GIVEN AND ACCEPTED IN LIEU OF ALL OTHER WARRANTIES, WHETHER EXPRESS OR IMPLIED, INCLUDING WITHOUT LIMITATION ANY WARRANTIES OF MERCHANTABILITY OR FITNESS FOR A PARTICULAR PURPOSE, OTHER THAN AS EXPRESSLY SET FORTH HEREIN. IN NO EVENT SHALL PRESTOLITE BE LIABLE FOR ANY ANTICIPATED OR LOST PROFITS, SPECIAL, DIRECT, INDIRECT OR INCIDENTAL DAMAGES, CONSEQUENTIAL DAMAGES, TIME CHARGES OR OTHER COMMERCIAL EXPENSES OR LOSSES, AND BUYER ASSUMES ALL RISK AND LIABILITY RESULTING FROM USE OF THE GOODS. PRESTOLITE DOES NOT AUTHORIZE ANY REPRESENTATIVE OR OTHER PERSON TO ASSUME ON BEHALF OF PRESTOLITE ANY OTHER LIABILITY IN CONNECTION WITH THE SALE OR USE OF THE GOODS SOLD, AND THERE ARE NO ORAL AGREEMENTS OR WARRANTIES COLLATERAL TO OR AFFECTING THIS WRITTEN WARRANTY.

WARNING

At all times, safety must be considered an important factor in the installation, servicing and operation of the product and skilled, qualified technical assistance should be utilized.

AMETEK/PRESTOLITE POWER - TROY, OHIO USA

Data Sheet: 1148
 Index: 060110
 Replaces: 030105