

OWNER'S MANUAL 193111-067

Revised February 25, 2010

IMPORTANT: Read these instructions before installing, operating, or servicing this system.

ULTRA MAXX

**Opportunity
Battery Charger**

DO NOT DESTROY

AMETEK/PRESTOLITE POWER , TROY, OHIO 45373-1099, U.S.A.

NOTE: Information regarding obtaining additional copies of this manual is located in the Introduction chapter of this manual.

A battery charger is identified by model number. Incorporated into the model number is the 8-hour ampere-hour capacity, case size, input power phase, and maximum number of cells in battery for which charger is intended. The following example explains the basic model numbering arrangement.

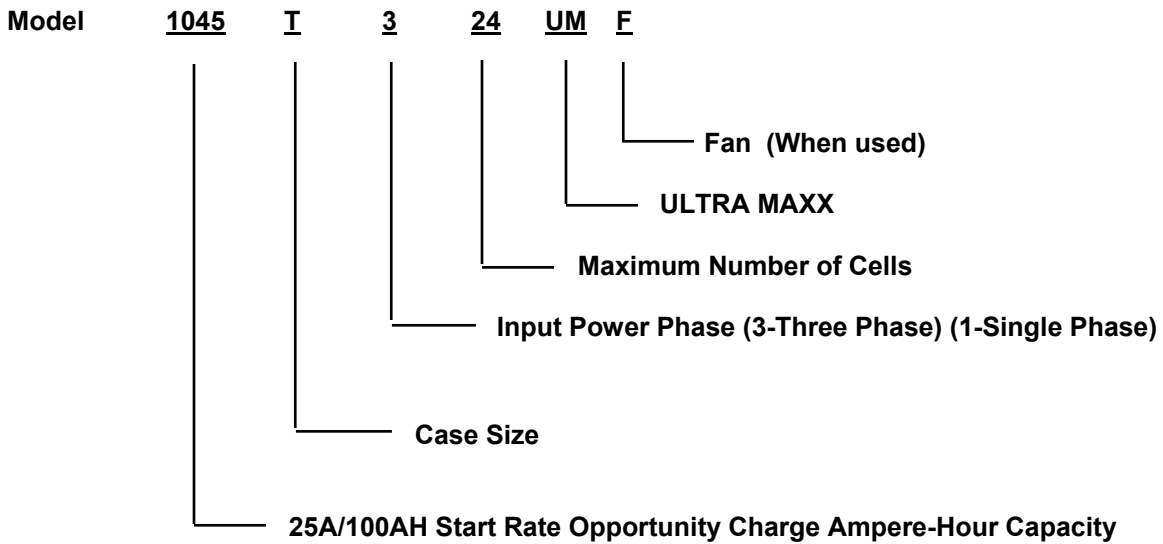

NOTE: This information is required for ordering certain replacement/service parts.

INTRODUCTION	1
How To Use This Manual	1-1
Equipment Identification	1-1
Receipt Of Equipment.....	1-1
SAFETY INSTRUCTIONS AND WARNINGS	2
DESCRIPTION OF EQUIPMENT	3
Operating Modes	3-1
Opportunity Charging.....	3-1
UC2000 Control	3-2
INSTALLATION	4
Location	4-1
Environmental Characteristics	4-1
Grounding	4-1
Line Voltage Changeover Instructions.....	4-2
Line Connections to Battery Charger.....	4-2
Charging Cable Connectors	4-3
Pre-operation Checks	4-3
Pre-Operation Changes to the Factory Control Settings	4-3
MAINTENANCE	5
OPERATION	6
Preliminary.....	6-1
Normal Or Daily Charge	6-1
Equalize Or Weekend Charge	6-2
Manual Stop.....	6-2
AC Power Fail.....	6-2
UC2000 CONTROL FEATURES	7
Main Features.....	7-1
Description of Features.....	7-2
UC2000 Charge Archive Function	7-5
UC2000 Charge Cycle Review Function	7-6
PROGRAMMING YOUR UC2000 CONTROL	8
Using Extended AH for Opportunity/Fast Charging	8-6
Multi Amp Hour Programming	8-7
Timer Start Mode Programming	8-8
OPTIONS	9
Parallel Charging	9-1
Series Charging.....	9-1
Fused Disconnect Switch	9-2
Remote Display kit.....	9-2
Wall Mounting Bracket.....	9-3
Lifting Eye Kit.....	9-3
Archive Downloading Kit.....	9-3
Arcless Disconnect.....	9-3
Remote Stop Pushbutton Kit.....	9-3

TROUBLESHOOTING **10**
 Troubleshooting Table..... 10-1
 Action 10-10

PARTS LIST **11**

DIAGRAMS

WARRANTY

INTRODUCTION

How To Use This Manual

IMPORTANT: It is especially important that all charger internal components be kept clean and dry, and all electrical connections tightened. Replace any precautionary or instruction label that cannot be easily read.

To ensure safe operation, read the entire manual, including the chapter on safety instructions and warnings.

Throughout this manual, the words **WARNING**, **CAUTION**, and **NOTE** may appear. Pay particular attention to the information provided under these headings. These special annotations are easily recognized as follows:

WARNING gives information regarding possible personal injury. Warnings will be enclosed in a box such as this.

CAUTION refers to possible equipment damage. Cautions will be shown in bold type.

NOTE offers helpful information concerning certain operating procedures. Notes will be shown in italics.

Equipment Identification

The unit's identification number (specification, model, serial number) usually appears on a nameplate attached to the front panel.

Receipt Of Equipment

When you receive the equipment, check it against the invoice to make sure it is complete and inspect the equipment for possible damage due to shipping. If there is any damage, notify the carrier immediately to file a claim. Furnish complete information concerning damage claims or shipping errors to the company shown on the cover of this manual. Include all equipment identification numbers and group part numbers (if any) as described above along with a full description of the parts in error.

Move the equipment to the site of installation before uncrating. Use care to avoid damaging the equipment when using bars, hammers, etc., to uncrate the unit.

Additional copies of this manual may be purchased by contacting the company shown on the cover of this manual. Include the Owner's Manual number and equipment identification numbers.

SAFETY INSTRUCTIONS AND WARNINGS

FOR OPERATION OF BATTERY CHARGING EQUIPMENT

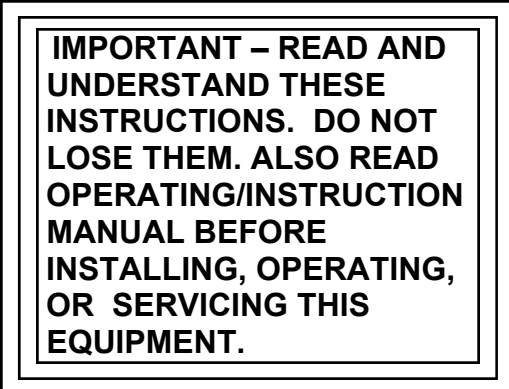

A. General

Battery charging products can cause serious injury or death, or damage to other equipment or property, if the operator does not strictly observe all safety rules and take precautionary actions.

Safe practices have developed from past experience in the use of charging equipment. These practices must be learned through study and training before using this equipment. Anyone not having extensive training in battery charging practices should be taught by experienced operators.

Only qualified personnel should install, use, or service this equipment.

B. Shock Prevention

Bare conductors, or terminals in the output circuit, or ungrounded, electrically-live equipment can fatally shock a person. To protect against shock, have competent electrician verify that the equipment is adequately grounded and learn what terminals and parts are electrically HOT.

The body's electrical resistance is decreased when wet, permitting dangerous current to flow through the body. Do not work in damp area without being extremely careful. Stand on dry rubber mat or dry wood and use insulating gloves when dampness or sweat cannot be avoided. Keep clothing dry.

1. Installation and Grounding of Electrically Powered Equipment – Electrical equipment must be installed and maintained in accordance with the National Electrical Code, NFPA 70, and local codes. A power disconnect switch must be located at the equipment. Check nameplate for voltage and phase requirements. If only 3-phase power is available, connect *single-phase* equipment to only two wires of the 3-phase line. **DO NOT CONNECT** the equipment grounding conductor (lead) to the third live wire of the 3-phase line as this makes the equipment frame electrically HOT, which can cause a fatal shock.

If a grounding lead (conductor) is part of the power supply cable, be sure to connect it to a properly grounded switch box or building ground. If not part of the supply cable, use a separate grounding lead (conductor). Do not remove a ground prong from any plug. Use correct mating receptacles. Check ground for electrical continuity before using equipment.

The grounding conductor must be of a size equal to or larger than the size recommended by Code or in this manual.

2. Charging Leads – Inspect leads often for damage to the insulation. Replace or repair cracked or worn leads immediately. Use leads having sufficient capacity to carry the operating current without overheating.
3. Battery Terminals – Do not touch battery terminals while equipment is operating.
4. Service and Maintenance – Shut OFF all power at the disconnect switch or line breaker *before* inspecting, adjusting, or servicing the equipment. Lock switch OPEN (or remove line fuses) so that the power cannot be turned ON accidentally. Disconnect power to equipment if it is to be left unattended or out of service.

Disconnect battery from charger.

Keep inside parts clean and dry. Dirt and/or moisture can cause insulation failure. This failure can result in high voltage at the charger output.

C. Burn and Bodily Injury Prevention

The battery produces very high currents when short circuited, and will burn the skin severely if in contact with any metal conductor that is carrying this current. Do not permit rings on fingers to come in contact with battery terminals or the cell connectors on top of the battery.

Battery acid is very corrosive. Always wear correct eye and body protection when near batteries.

D. Fire and Explosion Prevention

Batteries give off explosive flammable gases which easily ignite when coming in contact with an open flame or spark. Do not smoke, cause sparking, or use open flame near batteries. Charge batteries only in locations which are clean, dry, and well ventilated. Do not lay tools or anything that is metallic on top of any battery. All repairs to a battery must be made only by experienced and qualified personnel.

E. Arcing and Burning of Connector

To prevent arcing and burning of the connector contacts, be sure the charger is OFF before connecting or disconnecting the battery. (If the charger is equipped with an ammeter, the ammeter should not indicate current flow.) Always connect battery before turning charger ON.

F. Medical and First Aid Treatment

First aid facilities and a qualified first aid person should be available for each shift for immediate treatment of electrical shock victims.

EMERGENCY FIRST AID: Call physician and ambulance immediately. Use First Aid techniques recommended by the American Red Cross.

DANGER: ELECTRICAL SHOCK CAN BE FATAL. If person is unconscious and electric shock is suspected, do not touch person if he or she is in contact with charging leads, charging equipment, or other live electrical parts. Disconnect (open) power at wall switch and then use First Aid. Dry wood, wooden broom, and other insulating material can be used to move cables, if necessary, away from person. IF BREATHING IS DIFFICULT, give oxygen. IF NOT BREATHING, BEGIN ARTIFICIAL BREATHING, such as mouth-to-mouth. IF PULSE IS ABSENT, BEGIN ARTIFICIAL CIRCULATION, such as external heart massage.

IN CASE OF ACID IN THE EYES, flush very well with clean water and obtain professional medical attention immediately.

G. Equipment Warning Labels

Inspect all precautionary labels on the equipment. Order and replace all labels that cannot be easily read.

DESCRIPTION OF EQUIPMENT

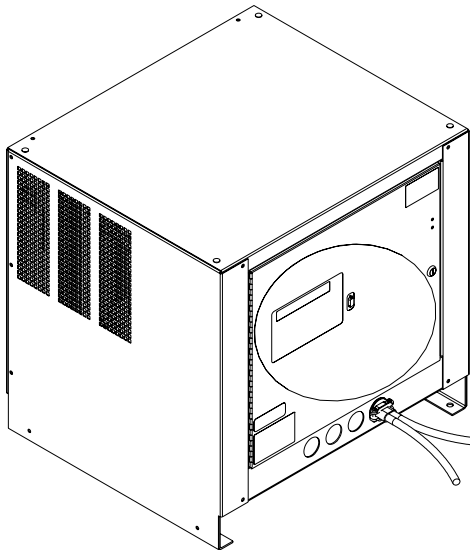

FIGURE 3-1

The basic charging circuit is the silicon controlled rectifier-type with isolating transformer (s). This SCR design regulates charging current by allowing the battery to determine its own charge cycle rate in accordance with its state of discharge. It provides a constant current-constant voltage-constant current (IEI) charge that eliminates the possibility of overcharging, even with line voltage variations of $\pm 10\%$ and allows the battery to finish at the proper current regardless of battery age or gravity type.

The ULTRA MAXX provides opportunity battery charging over a wide range of environmental conditions. The charger will precisely charge your battery based on battery temperature, type, and size; by automatically adjusting its own output charge characteristic within the power limits of the chargers power circuit.

When applied with the Prestolite Power optional Battery Identification Module (BID), the ULTRA MAXX identifies a battery selected for opportunity charging at the time of connection and adjusts its output for that specific battery. During the charge cycle, or duration of connection if used as an opportunity charger the ULTRA MAXX continuously monitors the battery's temperature via the BID and adjusts its output to match the battery temperature as it changes throughout the charge cycle.

Upon connection of the battery, the ULTRA MAXX reads the information programmed into the BID and identifies the battery's AH rating, cell size, type of construction, electrolyte temperature, and programmed method of charge and adjusts its output curve based on this information.

The ULTRA MAXX is internally protected against overload and short circuits by both input and output fusing, plus Prestolite's unique *curve monitoring circuit* periodically measures the output curve to ensure that the voltage and current are within the limits set at the factory.

Operating Modes

The ULTRA MAXX reads the information that was programmed into the BID Module during installation and charges the battery based on an opportunity charging profile or a profile designed to recharge a fully discharged battery in 8 hrs. Valve regulated batteries of several types can also be recharged at the 8 hour rates when equipped with a properly programmed BID Module.

The ULTRA MAXX always defaults to the BID mode when an installed BID Module is detected. The charger automatically adjusts its output to match the battery information programmed into the module.

The BID Module allows users with various cell size batteries to charge any battery on any charger without the fear of mismatching batteries and chargers. In applications where some batteries are to be opportunity charged, while others require 8 hour charge profiles the BID and ULTRA MAXX provide the most flexible solution.

Opportunity Charging

In applications utilizing opportunity charging, the high current output of the ULTRA MAXX returns significant capacity to the battery during short periods such as breaks, lunch and shift changes. In many applications battery changing can be eliminated completely.

UC2000 Control

The extreme flexibility of the ULTRA MAXX lies in the state of the art micro controller used in the UC2000 charger control.

The UC2000 is made up of two main components: the Control /Regulator Board, and the Keypad/Display. The Control portion provides the basic operating features of the charger, such as auto start/stop, auto equalize, charge cycle review, real time clock, communications, etc. The Regulator portion actually controls the firing or switching of the SCRs, thus controlling the chargers DC output.

The Keypad/Display provides the user interface with the charger. The durable membrane keypad is impervious to moisture and mechanical shock. The bright 2 line 20 character alphanumeric vacuum florescent display constantly shows the charger's output volts, amps, and amp hours returned during the charge cycle. The display also provides the user with plain English messages concerning charge cycle status.

Four bright LEDs molded into the keypad keep the user informed of charge status at a glance, even from long distances. LEDs notify you that a charge is in progress, that the battery is 80% charged, equalize cycle, charge complete, and fault indication.

WARNING: Do not connect a battery to this charger if any lamp is lit. Do not disconnect a battery from this charger while a charge is in progress. Otherwise, damage to charger, arcing and burning of connector parts or a battery explosion may result. Batteries produce explosive gases. Keep sparks, flame, and cigarettes away. Ventilate when charging in an enclosed area. Always shield eyes when working near batteries.

INSTALLATION

Location

For best operating characteristics and longest unit life, take care in selecting an installation site. Avoid locations exposed to high humidity, dust, high ambient temperature, or corrosive fumes. Moisture can condense on electrical components, causing corrosion or shorting of circuits (especially when dirt is also present).

Adequate air circulation is needed at all times in order to assure proper operation. Provide a minimum of 6 inches of free air space at rear and sides of the unit. Make sure that ventilation openings are not obstructed.

Always remove the charger shipping skid from the unit before installation. The charger must be installed over a noncombustible surface such as concrete or metal. Keep the charging area clear of all combustible material such as wood, paper, and cloth. When moving the charger after the packing skid and box have been removed, make sure that lifting forks do not damage the charger panels or cables.

WARNING: SPARKS OR MOLTEN METAL falling through open bottom can cause fire or explosion.

- Install over noncombustible material such as concrete or metal.
- Keep charging area clear of combustible material.

Environmental Characteristics

Operating Characteristics	0°C to 40°C (32°F to 104°F)
Operating Altitude	To 2000 Meters (6562 Feet)
Operating Humidity	80% up to 31°C, decreasing to 50% at 40°C, non-condensing 80% up to 88°F decreasing to 50% at 104°F, non-condensing

Grounding

The frame of the power source must be grounded for personnel safety. Where grounding is mandatory under state or local codes, it is the responsibility of the user to comply with all applicable rules and regulations. Where no state or local codes exist, it is recommended that the National Electrical Code be followed.

In addition to the usual function of protecting personnel against the hazard of electrical shock due to fault in the equipment, grounding serves to discharge the static electrical charges which tend to build up on the surfaces of equipment. These static charges can cause painful shock to personnel, and can lead to the erroneous conclusion that an electrical fault exists in the equipment.

If a charger is to be connected to the AC power supply with a flexible jacketed cable, one having a separate grounding conductor should be used. When included in cable assembly, grounding conductor will be green, green with a yellow stripe, or bare. When connecting input power to charger (as instructed in Line Connection to Battery Charger section of this manual), connect grounding conductor to equipment grounding terminal (stud with a green nut and a cup washer and identified by symbol $\underline{\text{E}}$), taking care to make a good electrical connection. Connect other end of grounding conductor to the system ground.

If, for any reason, an input cable which does not include a grounding conductor is used, the equipment must be grounded with separate conductor. Minimum size and color coding requirements must be in accordance with any applicable state or local code, or the National Electrical Code.

If metallic armored cable or conduit is used, the metal sheathing or conduit must be effectively grounded as required by state or local code, or the National Electrical Code.

If a system ground is not available, the charger frame must be connected to a driven ground rod (at least 8 ft [2438 mm] long), or to a water pipe that enters the ground not more than 10 ft (3048 mm) from the charger. A grounding conductor must be connected to the rod or pipe in a manner that will assure a permanent and effective ground. The conductor must be sized in accordance with any applicable state or local code, or by the National Electrical Code. If in doubt, use the same size conductor as is used for the conductors supplying power to the charger.

WARNING: ELECTRIC SHOCK HAZARD – Under no circumstance should you use a grounding conductor with a current carrying capacity less than the ampere rating shown in Table 4-1.

LINE AMPS	DISCONNECT SWITCH *	BRANCH FUSE SIZE (AMPERES)	COPPER CABLE SIZE AWG **	
			POWER	GROUND
0-2.5	30A	5	No. 14	No. 14
2.6-4.5	30A	7	No. 14	No. 14
4.6-7.5	30A	10	No. 14	No. 14
7.6-12	30A	15	No. 14	No. 14
12.1-16	30A	20	No. 12	No. 12
16.1-18	30A	25	No. 10	No. 10
18.1-22	30A	30	No. 10	No. 10
22.1-24.5	60A	35	No. 8	No. 10
24.6-32.5	60A	40	No. 8	No. 10
32.6-40	60A	50	No. 8	No. 10
40.1-45	60A	60	No. 6	No. 10
45.1-57.5	100A	80	No. 4	No. 8
57.6-78	100A	100	No. 2	No. 8
78.1-102.5	200A	125	No. 2	No. 6
102.6-135	200A	150	No. 1/0	No. 6

Table 4-1 Recommended AC Input and Branch Fusing

The above table (Table 4-1) is based on 75°C (167°F) rated conductors and 40°C (104°F) ambient temperatures. Refer to National Electrical Code (1999) Tables 310-16 corrected to 40°C (104°F).

* For 115, 208, and 230-volt lines, use 250-volt disconnect switch.
For 440-480, 575-volt lines, use 600-volt disconnect switch.

** Two conductors and ground conductor required for single phase.
Three conductors and ground conductor required for three phase.

Recommended minimum size of grounding conductors (based on National Electrical Code 1999 – Table 250-95).

Line Voltage Changeover Instructions

- Determine if the charger is connected for available line voltage. A label located near AC input terminals is marked with the AC voltage for which the charger is factory connected.
- If charger is not connected correctly, check serial nameplate to determine that charger is equipped to be connected for available line voltage. If charger is suitably equipped, make voltage changeover connections by following instructions on AC input label inside charger.
- If charger is reconnected, check input fuse (s) ratings with ratings specified on label and replace if necessary.

CAUTION: INCORRECT CONNECTIONS AND INCORRECT FUSE SIZE can damage this equipment. Follow voltage changeover instructions carefully.

Line Connections to Battery Charger

Follow local code requirements if different than instructions in this manual.

- Turn charger OFF.
- Be sure charger is connected correctly for available line voltage as instructed above.
- On charger nameplate, note the AC input amperes corresponding to the line voltage to which charger is to be connected. Use that ampere value to select the proper disconnect switch, fuse, and power cable sizes from Table 4-1. A "WARNING" label inside charger also lists fuse sizes for each line voltage (circled fuse rating is required for internal line voltage connections made at factory).
- Route AC power input cable in through knockout provided in side panel of charger cabinet. Securely fasten cable wires to a power input terminal inside charger. Refer to Grounding section of this manual for proper connection of grounding conductor. (Charger cabinet top or side panel, or both, may have to be removed to provide access to terminal block.)

5. With disconnect switch (on AC input power line) in "OPEN" or "OFF" position, connect power cable coming from charger, to the switch. Install fuses in switch.

Charging Cable Connectors

If connectors are already attached to charging cables, make sure that they are attached so that positive charger polarity will connect to positive battery terminal.

If connectors must be attached to charging cables, follow instructions supplied with connectors.

CAUTION: Make sure connectors are securely attached to cables (good solder joint or well tightened set screws, whichever is applicable). Be certain that positive charger cable will connect to positive battery terminal. If necessary, trace cables into charger and use supplied connection diagram to determine polarity. The use of a DC voltmeter may show polarity. Improper connections will "blow" output fuse and may cause other damage.

Note: If this charger is equipped with certain optional features, the connector attaching procedure may be modified. Refer to OPTIONS chapter of this manual for details.

Pre-operation Checks

1. Inspect charger thoroughly for damage; loose screws, nuts, or electrical connections.

WARNING: ELECTRICAL SHOCK HAZARD – Before inspecting or cleaning inside cabinet, turn OFF and remove fuses of disconnect switch (supplying AC power to charger) and disconnect battery.

2. Remove all special tags that are tied to charger. Keep tags with this manual for future reference. Leave all precautionary and instruction labels in place on charger. Carefully read and follow instructions on all tags and labels. Make sure all labels remain visible to anyone operating charger.
3. Make sure all charger cabinet panels are fastened in place, to assure proper flow of ventilating air through cabinet.

Pre-Operation Changes To The Factory Control Settings

Typically few changes are required to be made if the amp hour rating is sized to the battery and the voltage rating is equal to or greater than the battery. However, in some applications, some changes to the programmable control settings may be desirable. The most common changes are listed below:

TIME Factory Setting for Time is Eastern Standard. (see Programming the UC2000).

NO GASSING HOURS Factory Setting is 0 (see Programming the UC2000).

MAX BATTERY TEMPERATURE Factory Setting is 150° F (see Programming the UC2000).

NOTE: It is advisable to check the day of the week, date, month, and year for accuracy

AUTO EQUALIZE Factory setting is ON (see Programming the UC2000).

AUTO EQUALIZE TYPE Factory setting is by Cycle (see Programming the UC2000).

AUTO EQUALIZE COUNT Factory setting is 05 (see Programming the UC2000).

Other functions are available for programming the UC2000 to meet your specific charging needs. Programming these functions is described in the Programming Your UC2000 chapter of this manual.

MAINTENANCE

WARNING: ELECTRICAL SHOCK HAZARD — Before inspecting or cleaning inside cabinet, turn OFF and remove fuses of disconnect switch (supplying AC power to charger) and disconnect battery.

Inspection And Cleaning

For uninterrupted, satisfactory service from this charger, it's necessary to keep unit clean, dry, and well ventilated. At least every three months, or more often as necessary, wipe and blow out all dirt from unit's interior components, with clean, dry air of not over 25 psi (172 kPa) pressure. Use a hand bellows if compressed air isn't available.

If the unit is equipped with a fan, be sure to check for proper unrestricted operation. The fan should operate anytime a discharged battery is connected.

Check and tighten all electrical connections as necessary to eliminate unnecessary losses and to avoid subsequent trouble from overheating or open circuits. Check for broken wiring or damaged insulation on wiring.

WARNING: ELECTRICAL SHOCK HAZARD — Failure to keep internal parts clean and dry may allow transformer (s) to short out, causing secondary circuits to carry dangerously high voltage.

Be sure to replace all charger cabinet panels after any servicing, to assure proper flow of cooling air through unit and to protect internal components.

WARNING: ELECTRICAL SHOCK HAZARD — All cabinet panels must be replaced to protect personnel from contact with hazardous voltages.

Lubrication

None required.

Fuse Replacement

The SCRs and silicon diodes in this charger are protected by a "fast-clearing" type fuse.

CAUTION: The use of any other type fuse besides the "fast-clearing" type may cause damage to silicon diodes.

OPERATION

The operating procedure given here explains the operation of a Prestolite ULTRA MAXX equipped with the Prestolite UC2000 control.

NOTE: If this charger is equipped with certain optional features, the operating procedure may be modified. Refer to Options chapter of this manual for details. Options not covered in this chapter will be described on separate "addendum" sheets enclosed with the manual.

Preliminary

1. Make sure that charger is installed and grounded as instructed in this manual.
2. Turn on main fused disconnect switch that supplies AC power to charger.
3. Maintain electrolyte level in batteries to be charged, as instructed by battery manufacturer. The volume of electrolyte will expand during the charge. Therefore, to avoid overfilling, do not add water until the battery has received at least an 80% charge. This will usually be reached at the time gassing starts.

Normal or Daily Charge

(For batteries with ampere-hour capacity within the range shown on charger nameplate)

1. Insure that battery size matches the charger and/or charger setting. (Number of cells is equal to or less than the charger nameplate rating and ampere-hour capacity is within charger nameplate rating.) To opportunity charge at the full output capability of the charger, it is necessary for the battery to be equipped with a Prestolite Power BID module.
2. Securely engage the battery and charger connectors.
3. The charger will display READING BID and update the progress bar. (2 to 7 seconds) as the data is read into the charger.
4. After a short delay, the charger will turn on and the "Charge in Progress" LED will light. The alphanumeric display will indicate the cell size, amp hour and phase settings for the upcoming charge cycle. Then it will display current charging cycle information. If not in the Maxx operating mode, "Verifying Battery" may appear for several minutes if the mult-cell mode is on.

5. The "80% Charged" LED will light when the battery has reached the gassing point.
6. When the charge termination point is reached, the charger will turn off and the "Charge Complete" LED will be lit. If an equalize charge has been selected, the "Equalize" LED will be lit.

NOTE: To disconnect battery from charger before charge is complete, press the red "Stop" key on the charger control panel.

NOTE: While not normally required, the charging rate may be adjusted to compensate for unusual ambient temperature, age of battery, etc. Refer to items 33 through 42 in Programming Your UC2000 chapter of this manual.

WARNING: EXPLOSION HAZARD
- Do not connect or disconnect a battery unless the "Charge in Progress" LED is off; otherwise, damage to charger, arcing and burning of connector parts or a battery explosion may result (batteries produce explosive gases). Keep sparks, flame, and cigarettes away. Ventilate when charging in an enclosed area. Always shield eyes when working near batteries. Disconnect battery if charger is to be turned off for prolonged periods of time.

NOTE: To disconnect battery from charger before charge is complete, press the red "Stop" key on the charger control panel.

Equalize or Weekend Charge

Batteries may need periodic equalizing to correct for inequalities between cells that result from daily or frequent cycling. An equalizing charge should be given if any of the following conditions exist:

1. The specific gravity of any cell at the end of charge is 20 points less than the average.
2. The on-charge voltage of any cell at the end of charge is 20 MV less than the average.
3. The battery has been stored for 30 days.
4. A large volume of water has been added.

When the equalize mode is desired, follow the operation outlined for a normal charge and press UC2000 "Equalize" key to set the charge control for an Additional 3 hours more than required for a normal charge. The charge is complete when charge control automatically lights the "Charge Complete" LED.

NOTE: The UC2000 is shipped from the factory set to the Auto Equalize by Cycle mode, and will automatically provide an equalize charge every 5 complete cycles.

Manual Stop

To stop any charge cycle before charge complete, press the red "Stop" key. For maximum shift run times and longest battery life, the charger should be allowed to always reach charge complete.

WARNING: Do not connect a battery to this charger if any lamp is lit. Do not disconnect a battery from this charger while a charge is in progress. Otherwise, damage to charger, arcing and burning of connector parts or a battery explosion may result. Batteries produce explosive gases. Keep sparks, flame, and cigarettes away. Ventilate when charging in an enclosed area. Always shield eyes when working near batteries.

AC Power Fail

The UC2000 Control will resume the charge where it left off when the AC power failure occurred, virtually unaffected charge time.

As power is returned, if a charge cycle was in progress, the display may show "ACFAIL RESTART". The charger is staggering the restart based on cycle run times. This will prevent multiple chargers from restarting all at once, minimizing peak restart power.

NOTE: If a battery is disconnected from the charger during an AC power failure and discharged, reconnecting it or any other battery may result in an incomplete charge cycle.

WARNING: ELECTRICAL SHOCK HAZARD – Before checking electrical components, turn off and remove fuses or disconnect switch (supplying AC power to charger) and disconnect battery.

Abnormal Shutdowns

1. Manual Stop
If the manual stop key is pressed during the charge cycle, the charger will shutdown. All 4 LEDs will be flashing and the display will read "Manual Stop Fault".
2. Back-Up Timer Shutdown
The standard UC2000 Control has two back-up timers. The charger will shutdown and "Backup timer" will be displayed if 9* hours has passed since the start of a charge cycle and the battery has not reached gassing voltage (80% charged), or if 4 hours has passed since the battery has reached gassing voltage and a DV/DT charge termination has not occurred. If the DV/DT feature has been disabled (see Voltage Time section), only the nine-hour back-up timer is active.

*5 hours when in MAXX MODE.
3. Battery Disconnect Shutdown
If a battery is disconnected from the charger during a charge cycle, the charger will be shut down. All LEDs will be off.

-
- | | |
|--|---|
| <p>4. Low Current Shutdown
If the charger output falls below a predetermined level, a low current shutdown will occur. All 4 LEDs will be flashing and the display will read "Low Current Fault".</p> <p>5. Curve Error Shutdown
If the charger output becomes uncontrolled and falls above or below the proper level for predetermined period of time, the charger will shutdown. All 4 LEDs will flashing and the display will read "Curve Error Fault".</p> <p>6. Unbalance Input Current Shutdown
If the charger input current becomes unbalanced for a predetermined period of time, the charger will shutdown. All 4 LEDs will be flashing and the display will read "Unbalanced Line Fault".</p> <p>7. Didt Shutdown
After the 80% charged point, if the output current begins to rise for more than a predetermined time period, the charger will be shutdown. All 4 LEDs will be flashing and the display will read "Didt Fault".</p> <p>8. Low Voltage Shutdown
If a battery on charge does not reach a minimum on charge voltage in a predetermined period of time, the charger will be shutdown. All 4 LEDs will be flashing and the display will read "Low Voltage Fault".</p> | <p>9. High Amp Hour Returned Shutdown
If the cycle amp hours returned exceed the BID AH setting or charger maximum AH rating for a predetermined amount, the charger will shutdown. All 4 LEDs will be flashing and the display will read "High Amp Hour Fault".</p> <p>10. Bad BID Read Shutdown
After 30 minutes have passed into a charge cycle, a BID reading will take place, if the presence on a BID is detected where one was not at battery connect, the charger will shutdown. All 4 LEDs will be flashing and the display will read "Bad BID Fault".</p> <p>Charger Input Phase Setting</p> <p>The charger control must be set to match input phase of the charger. All units received from the factory will have this item preset. To toggle the control setting, press and hold either the 1 (1 phase) or 3 (3 phase) front panel key for 3 seconds at AC power up.</p> |
|--|---|

UC2000 CONTROL FEATURES

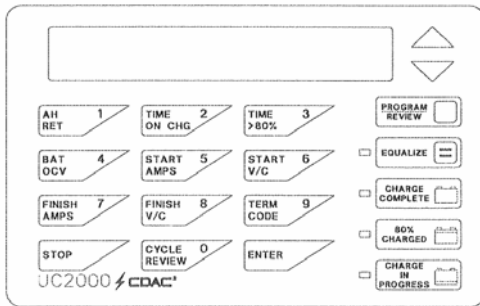

Figure 7-1

Main Features

1. 25 A/100AH high rate opportunity charging output.
2. Multi-Voltage Charging Capability
3. Multi-Ampere-Hour Charging Capability
4. Automatic or Manual Battery Temperature Compensation
5. 15 Minute Minimum DV/DT Charge Termination
6. 2x20 Character Alphanumeric Display
7. Four LEDs for Status Display
8. LED lamp test provided on start up
9. Manual Stop Capability
10. One touch Review of Charge Cycle Information during charge cycle or after charge complete
 - Amp hours returned during charge cycle
 - Total time on charge
 - 80% point to end of charge timer
 - Battery open circuit voltage
 - Start current
 - Start voltage (volts/cell)
 - Finish current
 - Finish voltage (volts/cell)
 - Charge termination code
11. Review of Charge Cycle Data and Programmed Features
12. Review of Archived Charge Cycle Data for the Last 99 Charge cycles.
 - Amp hours returned during charge cycle
 - Total time on charge
 - 80% point to end of charge timer
 - Battery open circuit voltage*
 - Start current
 - Start voltage (volts/cell)
 - Finish current
 - Finish voltage (volts/cell)
 - Charge termination code
 - Equalize time
 - Start time
 - End time
 - Truck I.D.
 - Battery I.D.
 - Battery I.D. start temperature
 - Battery I.D. end temperature
 - Cycle ampere-hours
 - Cycle cell size
 - Battery Type*
 - Month
 - Date

* NOT INCLUDED ON DATAMATE REPORT
13. Automatic or Push-to-Start Operation
14. Manual or Automatic Equalize Operation
15. Fault Lock-out or No Fault Lock-out Operation
16. Back-up Timer Shutdowns
17. Failure Mode Diagnostics
 - High Battery Reject
 - Low Battery Reject
 - Battery Reject
 - Battery Over-temperature
 - Setup Error
 - Low Voltage S.D.
 - Charge Curve Error
 - Low Current S.D.
 - Backup Timer
 - Manual Stop
 - Fault Lockout
 - Over Maximum Amp Hour Returned S.D.
 - Unbalanced Line S.D.
 - DIDT S.D.
 - BID Read Error

18. One Part Number Control is User/Factory programmable for 6-9-12-18-24 Cells and 100-200-400-600 Amp Digital Ammeter
- Note: Units that include 36 and 40 cells require an additional part number.*
19. Adjustable 8-99 Hour Refresh Charge Delay
20. Voltage Time Feature (DV/DT Disable)
21. "Cell Forming" Feature (Programmable from 0-30 Cycles)
22. Programmed Features and Archive Data maintained for a minimum of 10 Years
23. Charge Cycle Data and Time-of-Day/Date maintained for a minimum of 10 Years
24. 6 Programmable Start Modes
- Automatic Start (5 Second Delay)
 - Push-To-Start
 - Delayed Start
 - Time-of-Day Start
 - Time-of-Day Blockout
 - Timer Mode
25. Programmable Manual Override of Start Modes
26. User Programmable Password
27. Automatic Equalize By Number of Charger or BID Cycles, Day of Week
28. Programmable Cool Down Time
29. Staggered Start on ACFAIL Recovery

Description of Features

Multi-Voltage Charging — The ULTRA MAXX with UC2000 Control provides the capability to charge batteries of different cell sizes. With the Multi-Cell Mode ON, the charger automatically selects the proper output voltage. A 24 cell ULTRA MAXX will safely charge 24, 18, 12, 9, and 6 cell batteries. An 18 cell ULTRA MAXX will safely charge 18, 12, 9, and 6 cell batteries. A 12 cell ULTRA MAXX will safely charge 12, 9, and 6 cell batteries.

Fixed mode operation can be selected by programming Multi-Cell mode to OFF. In this mode the charger will charge only batteries of the cell size programmed into the Fixed-Cell size function.

If the battery is equipped with Prestolite BID Module, the Multi-Cell ON or OFF function will be overridden and the charger will charge the battery if it is within the charger output rating.

Multi-Ampere-Hour Charging — The ULTRA MAXX with UC2000 Control provides the capability of charging batteries of different cell sizes at the proper charge rates. Fixed Mode can be selected by programming an amp hour rating into the Fixed AH size function that is less than the charger ampere-hour nameplate rating. The output current will be adjusted to deliver current at the proper rate. Attempts to program ampere-hour sizes larger than the nameplate rating will not be accepted by the control.

If the battery is equipped with a Prestolite BID Module, the Fixed Ampere-Hour function will be overridden and the charger will charge the battery at the rate programmed into the BID Module (BID Module programming is performed at the factory based on information provided by the customer) if it is within the charger output rating. If the BID and battery ampere-hour rating are greater than the charger rating, the charger will charge the battery at the nameplate amp hour rating.

Multi-AH Programming Feature — The Multi-AH Programming Feature allows the control to be programmed to charge different voltage batteries with the AH rates and curve types that have been programmed for that battery voltage. When a battery is connected, the control automatically senses the battery voltage and sets the charge curve and charging rates to the level that has been programmed.

If the battery is equipped with a Prestolite BID Module, the Fixed Ampere-Hour function and Multi-AH Programming will be overridden and the charger will charge the battery at the rate programmed into the BID Module (BID Module programming is performed at the factory based on information provided by the customer) if it is within the charger output rating. If the BID and battery ampere-hour rating are greater than the charger rating, the charger will charge the battery at the nameplate amp hour rating.

Temperature Compensation — The ULTRA MAXX with UC2000 Control is capable of modifying the output voltage to compensate for ranges of battery electrolyte temperatures from 32 to 132 degrees F. Because the 80% percent point is based on reaching a point on the charge curve rather than a single voltage, it is automatically adjusted with the output voltage.

CAUTION: Consult your batteries manufacturer for the recommended maximum battery temperature for your battery.

When the battery is equipped with a Prestolite BID module, the charger automatically reads the battery temperature throughout the charge cycle and adjusts the output voltage to match the battery temperature.

Manual adjustment of the charger output voltage to match the temperature of the battery is performed by programming the proper battery electrolyte temperature into the Fixed Battery Temperature function (BID readings automatically override the Fixed Battery Temperature setting).

Max Battery Temperature—The UC2000 monitors the battery temperature throughout the charge cycle. Programming the MAX BATT TEMP setting of the control to the desired maximum battery temperature will cause the charger to shut down if the battery on charge is equipped with a BID and the temperature exceeds the set point. It will wait until the battery temperature has decreased to 5 degrees C below the set point before restarting the charge cycle.

Charge Termination — The UC2000 utilizes a patented proportional time DV/DT technique in order to determine the charge termination point. This technique returns approximately 107% of the amp hours removed from a battery (regardless of the state of discharge) and prevents variations in the incoming AC line voltage from affecting the amount of Energy returned to the battery. The minimum time required for a DV/DT charge termination on the UC2000 Control is fifteen minutes. The UC2000 Control can be programmed to utilize a voltage-time charge termination technique. If the DV/DT charge termination is disabled, the control will terminate the charge cycle four hours after the battery reaches the “80% Charged” point.

Alphanumeric Display — A vacuum florescent dot matrix 2x20 character display is standard on the UC2000 Control. The characters are .35 inches tall, making the information on the digital display legible at distances exceeding ten feet. Plain English and easy to understand abbreviations are used to indicate charge status output current and voltage and other functions including; archive information, review information, programming information, fault information, and operating status. A blank display is utilized for AC power fail indication.

Status Display LEDs — The “Charge In Progress” LED (Amber) is illuminated whenever the charger is flowing current to the battery. There are four status LEDs provided to indicate the present operating status of the charger and battery (see Figure 7-1). A lamp test feature is provided. See [Review of Charge Cycle](#) feature.

Review of Charge Cycle — When the charge cycle is in progress or has been terminated, either by the UC2000 Control or the operator, the charge cycle history can be automatically read out by pressing the “Cycle Review” key. After displaying the information from memory, the unit will return to the normal (ULTRA MAXX) display.

All status LEDs will be illuminated during the review of function number one, thus providing a lamp test feature. Nine functions are displayed during a standard review. If the charger is idle, the information in all 58 review functions can be displayed. See the [UC2000 Charge Cycle Review Feature](#) section in this chapter. A single item can be selected by pressing the appropriate labeled key. This feature can greatly aid in the analysis of charge data and in situations where troubleshooting is required. See the [Troubleshooting](#) chapter in this manual.

Automatic or Push-to-Start Operation — In the automatic start mode, the charger will start 5-15 seconds after the battery is connected. The alphanumeric display will display “READING BID” and then display upcoming cycle information. In the push-to-start mode, the charger will not start the charge cycle until the “Enter” key is pressed. “Ent to Start Charge” will be displayed on battery connect when this feature has been selected.

Manual or Automatic Equalize — An equalize charge is a prolonged charge cycle (by 3 hours) used to correct any inequalities of voltage and specific gravity which may have developed between the cells during service. UC2000 Controls are shipped from the factory with the automatic equalize feature enabled. This mode of operation is indicated in the full Review “AUTO EQ. ON” function. There are three modes of automatic equalize. See the [Automatic Equalize](#) section in this chapter for further details. When the automatic equalize feature is active, the “Equalize” key on the front panel is disabled. When automatic equalize is disabled, an equalize charge is requested by pressing the “Equalize” key on the front panel of the UC2000 Control during countdown or after the charge cycle has started. If this key is pressed again during the charge cycle, the equalize request will be canceled if the equalize period has not begun.

Fault Lockout Operation — In the normal operating mode (No fault lock-out), if an abnormal shutdown occurs, disconnecting and reconnecting the battery will clear the fault and the UC2000 will restart the charge cycle as programmed. If an abnormal shutdown occurs with the fault lock-out feature enabled, disconnecting and reconnecting a battery will not clear the fault condition.

The alphanumeric display will display fault lockout, and the status LEDs will continue to flash even with no battery connected to the charger until the fault condition is cleared. The "Enter" key will clear the fault if it is pressed while a battery is not connected to the charger.

One Part Number Control — The standard UC2000 Control is user/factory programmable for 6, 9, 12, 18, and 24 cell ULTRA MAXXs with 100, 200, 400, and 600 amp shunts. Any combination of the above cell sizes and current shunt sizes can be selected by DIP switches on the P.C. board. This feature reduces the quantity of spare parts inventory. See Figure 8-1 for further information.

Refresh Charge Feature — A refresh charge of a storage battery is a charge given to charged and wet batteries which are in storage or inactive periods to replace losses due to local action and to insure that every cell is brought periodically to a full state of charge. The UC2000 Control has an adjustable 8 to 99 hour refresh charge timer (programmed through the "Refresh Delay" function) which starts with a normal charge complete, either DV/DT or voltage time. If a battery is left connected to the charger for the Programmed number of hours after a charge complete, the control will automatically begin a refresh charge cycle. The control will start automatically even if programmed for time-of-day start, delayed start or push-to-start operation. The UC2000 will not start the charge cycle during a time-of-day blackout period. It will automatically request an equalize cycle if it is programmed to equalize on that day. Charge cycle data (Functions #1-50) is not affected by a refresh charge. The charge termination technique for a refresh charge will be DV/DT regardless of how the control is user programmed, and the 0-80% back-up timer will be four hours and fifteen minutes during a refresh charge. This feature will insure that any battery left connected to the charger for extended periods of time will not be damaged due to self-discharge, and will be kept in a fully charged state.

Finish Cell Forming Feature — The UC2000 Control can be programmed to provide voltage-time charge termination and disable the low current shutdown feature for a limited number of charge cycles.

The number of cycles programmed into the Forming Cycles function will be forming cycles and that number will be decrement each time a charge complete condition is reached. The number of forming cycles selected can be from 0 to 30 charge cycles.

WARNING: Enabling the Finish Cell Forming feature will cause the charger to continue to run for a period of time if the battery has been disconnected before Charge Complete or pressing the Manual Stop key. This condition will continue until the programmed number of cycles have been completed. The battery should never be disconnected while a charge is in progress.

Input Kilowatt Hour Feature — The Control will calculate the *approximate* input kilowatt hour usage for each charge cycle. This feature may be helpful in determining the cost of charging given various charging scenarios with known electricity costs.

80% Charged Point — A standard UC2000 Control will light the "80% Charged" LED and enable the charge termination routine when the battery voltage reaches the gassing voltage and the charging has decreased below start current. The gassing voltage is nominally 2.40 volts/cell and is adjusted automatically when the charger output voltage is modified to charge batteries of different temperatures.

Data Retention — The UC2000 Control uses 2 types of electronic memory for data retention. Real time clock data is kept current by a non user replaceable lithium battery in the absence of AC power. All other program memory and charge cycle information is resident in non-volatile flash memory. The minimum data retention time should be at least 10 years.

Time-of-Day Start — The UC2000 Control can be programmed to delay the start of a charge cycle until a specific time of day. Any time of day, in one minute increments, can be used for the time-of-day start time.

When a UC2000 is programmed for time-of-day start, and a battery is connected to the charger, the programmed start time will be displayed. This feature can be used to save on energy costs, provide a battery cool down period, or to prevent opportunity charging.

Delayed Start — The UC2000 Control can be programmed to delay the start of a charge cycle for a specific period of time. Any time period from 1 minute to 23 hours and 59 minutes, in one minute increments, can be used for the delayed start period.

When a UC2000 is programmed for delayed start, and a battery is connected to the charger, the programmed delay time will be displayed.

The time displayed will be decremented once per minute so that the time displayed is always the amount of time remaining before the start of charge. This feature can be used to save on energy costs, provide a battery cool down period, or to prevent opportunity charging.

Time-of-Day Blockout — The UC2000 Control can be programmed to disable the charger during a specific time of day. The charger will turn off at the beginning of the blockout period, and resume the charge cycle at the end of the blockout period. Any period of time of day, in one minute increments, can be used for the time-of-day blockout period. When a UC2000 is programmed for time-of-day blockout, and a battery is being charged when the blockout period occurs, the programmed end of blockout time will be displayed. This feature can be used to save on energy costs, provide a battery cool down period, or to prevent opportunity charging.

Manual Override of Programmed Start Modes — A UC2000 Control, when programmed for time-of-day start, delayed start, or time-of-day blockout, can be manually overridden by pressing the “Enter” pushbutton while the start of the charge cycle is being automatically delayed by the control. This manual override feature can be disabled through the “Start Override” programming function. The manual override feature allows the operator to start a charge cycle immediately if a battery is needed sooner than the programmed start time would allow.

Automatic Equalize — The UC2000 Control can be programmed for 3 different types of automatic equalize. UC2000 Controls are shipped from the factory programmed to automatically provide an equalize charge to every fifth complete charger cycle. The number of cycles between equalize requests can be varied from 0 to 30. If the UC2000 is programmed to automatically provide an equalize cycle every zero cycles, then an equalize charge cannot be requested manually and will never be provided automatically. The second type of automatic equalize mode is when an equalize charge is desired on a particular day of the week. When programmed for automatic equalize by day of week, the UC2000 will provide an equalize charge to any battery which is connected to the charger on the programmed equalize day. Additionally, any battery which is connected the charger previous to the day of week equalize day will be given an equalize charge provided that it is at a charge complete status when the UC2000’s clock calendar switches to the equalize day.

The automatic equalize features allow for the consistent application of equalize charges without constant attention by the operators. The third type of equalize is by BID count. When programmed for this mode, the current complete cycle count is read from the BID at connect and compared to that of the equalize cycle counter. An equalize will be requested when the BID count equals the equalize cycle count programmed into function 22.

For further information on programming and reviewing the UC2000 features, refer to the Programming Your UC2000 chapter and the Reviewing UC2000 Charge Data section of this chapter.

Programmable Cool Down Time — A programmable cool down feature allows the battery to cool down for 0 to 8 hours before the charger signals charge complete. During the cool down period the alphanumeric display reads “Cool Down”. This feature allows the battery to cool down before being returned to use and can be used to minimize the battery maximum temperature during operation.

Start Gassing – A programmable time that effects how long from the start of a charge cycle before the gassing portion can begin. If the battery on charge reaches the finish portion of the curve and the gassing time has not elapsed, the charger current will be allowed to go down to 1.5A/100. This minimizes any battery gassing that may occur during an opportunity charge cycle. Once the start gassing time is past, the charger will go back to the standard finish current and complete the charge cycle. This feature only works when the charger is in ULTRA MAXX mode.

Maximum Battery Temperature — The UC2000 Control can be programmed to interrupt the charge cycle if the battery temperature exceeds the limit programmed into function. The temperature may be programmed from 80°F to 150°F. Once the battery cools down past the trip temperature the charge cycle will be resumed. The display will show “Battery Cooling” if the charge has been interrupted and the cooling period is taking place. A BID must be in use to utilize this function.

User Programmable Password — You may enter a custom 4 number password for use in keeping programming functions protected. When the feature is enabled (function 55), you will be prompted to enter the password. After that, anytime the user tries to access the programming menu, they will be prompted for this password.

Programmable Start Rate Charging (Extended AH) - Batteries of any AH rating less than the charger nameplate AH rating that are equipped with a BID module, can be configured for fast charging at start rates up to 50 amps/100AH. This mode enables fast/opportunity charging for a wide range of battery ratings. To operate in this charging mode, program the "BID battery type" (menu item 54) to curve 8, and the "BID Start Amps" (menu item 60) to the desired charger start rate in amps/100AH. For example, to charge an 800AH battery at 320 amps, the "BID Start Amps" would be programmed to 40A/100AH. Please note that if the programmed rate exceeds the maximum rated charger amps, the charger output will be limited to the maximum current rating.

UC2000 Charge Archive Function

The archive function allows up to 21 items of charge cycle information to be retrieved and displayed. The last 99 charge cycles are stored, with the most recent cycle labeled #1 and earlier cycles labeled in ascending order.

The most recent charger cycle data is moved to the #1 archive location when the next battery to be charged is connected to the charger. At this time the all previous archive cycle data is shifted to the next highest archive location (1 to 2, 2 to 3, etc.).

The following key sequence is used to access charge cycle archive data:

Keys	Display
PROGRAM/REVIEW	Enter → 1-REV 2-PROG Function 3-MAH 4-ARCH
4	Enter Arch Func # → 01 01-99/00 to Download

Key in the charge cycle number and press enter.

The charge cycle data will automatically scroll through the display along with the charge cycle number. The 19 archive data items are described in detail below (see Figure 7-2).

AMP HOURS RET

The total ampere-hours returned during the charge cycle. This number includes ampere-hours delivered to the battery during the Verify, 0-80%, 80% to End, and Equalize portions of the charge cycle.

CHARGE TIME

The total charging time of the charge cycle. This number includes the time of the Verify, 0-80% 80% to End, and Equalize portions of the charge cycle.

80% TO END

The time the battery was charged from the 80% charged point until DV/DT or VT (depending on the control setting) charge termination. This time does not include any equalize charging time that may have been automatically or manually selected.

BATTERY OCV

The open circuit voltage of the battery immediately before the beginning of the charge cycle.

START AMPS

The value of the current delivered to the battery at the start of the charge cycle.

START VOLTS

The value of the battery voltage (in volts/cell) of the battery at the start of the charge cycle.

FINISH AMPS

The value of the charge current delivered to the battery at the end of the charge cycle.

FINISH VOLTS

The value of the battery voltage at the end of the charge cycle.

TERM

The reason for charge cycle termination. All possible codes are listed below:

1-Charge Comp	Normal Charge Complete
2-Low Current	Low Current Error shutdown
3-Manual Stop	Manual stop
4-Battery Dis	Battery disconnected while charging
5-<80 Backup	0-80% Back-up Timer Error shutdown.
7-Cooling Int	CDAC function
8-CDAC Rej	CDAC Battery Rejection
9-Curve Error	Charger Output Curve Error shutdown
11-Unbal Line	Unbalanced Input Line Error shutdown
12-Didt	Rising Current/Falling Voltage Error shutdown
13-Lvsd	Low Charging Voltage Error shutdown
14-Ahsd	Excessive AH Returned Error Shutdown
15-BID Read	BID Error Shutdown

EQUALIZE TIME

The time of the equalize portion of the charge cycle. Equalize can be automatically or manually selected.

START TIME

The time at the start of the charge cycle (military format).

END TIME

The time at the end of the charge cycle. Includes the equalize time if it was automatically or manually selected (am/pm format).

TRUCK I.D.

The Truck I.D. number of the truck that the battery was discharged in prior to the charge cycle. Requires Prestolite Truck and Battery Identification Modules (TID and BID).

BATTERY I.D.

The Battery I.D. number of the battery that was charged in the charge cycle. Requires Prestolite Battery Identification Module (BID).

BID START TEMP

The temperature of the battery sensed by the Prestolite Battery Identification Module at the start of the charge cycle.

BID END TEMP

The temperature of the battery sensed by the Prestolite Battery Identification Module at the end of the charge cycle.

CYC. AMP HOURS

The Ampere-hour setting of the charger during the charge cycle. This value cannot exceed the maximum charger output rating.

CYCLE CELLS

The Cell Size setting of the charger during the charge cycle. This value cannot exceed the maximum charger output rating.

BATTERY TYPE

The Battery Type setting of the charger during the charge cycle. This value cannot exceed the maximum charger output rating.

PRESENT MONTH

The month that the charge cycle occurred.

PRESENT DATE

The day of the month that the charge cycle occurred.

UC2000 Charge Cycle Review Function

The review function allows up to 58 (59 for 36 & 40 cell assemblies) items of charge cycle information to be retrieved and displayed. Only the last charge cycle is stored, with the data being moved into archive cycle #1 location when the next battery is connected to the charger. The review data functions described in detail below in ascending order.

A single review item can be accessed by entering its item number at the "Enter Rev Func # →" prompt.

The following key sequence is used to access charge cycle review data functions.

Keys	Display
Program/Review	Enter → 1-REV 2-PROG Function 3-MAH 4-ARCH
1	Enter Rev Func # → 01

Key in function number and press enter or scroll using arrow keys to review entire charge cycle (see Fig. 7-2). You may re-enter a new function number at any time to jump through the menu quickly.

01. AMP HOURS RET

The total ampere-hours returned during the charge cycle. This number includes ampere-hours delivered to the battery during the Verify, 0-80%, 80% to End, and Equalize portions of the charge cycle.

02. CHARGE TIME

The total charging time of the charge cycle. This number includes the time of the Verify, 0-80%, 80% to End, and Equalize portions of the charge cycle.

03. 80% TO END

The time the battery was charged from the 80% charged point until DV/DT or VT (depending on the control setting) charge termination. This time does not include any Equalize charging time that may have been automatically or manually selected.

04. BATTERY OCV

The open circuit voltage of the battery immediately before the beginning of the charge cycle.

05. START AMPS

The value of the current delivered to the battery at the start of the charge cycle.

06. START VOLTS

The value of the battery voltage (in volts/cell) of the battery at the start of the charge cycle.

07. FINISH AMPS

The value of the charge current delivered to the battery at the end of the charge cycle.

08. FINISH VOLTS

The value of the battery voltage at the end of the charge cycle.

09. TERM

The reason for charge cycle termination. All possible codes are listed below:

1-Charge Comp	Normal Charge Complete
2-Low Current	Low Current Error shutdown
3-Manual Stop	Manual stop
4-Battery Dis	Battery disconnected while charging
5-<80 Backup	0-80% Back-up Timer Error shutdown.
7-Cooling Int	CDAC function
8-CDAC Rej	CDAC Battery Rejection
9-Curve Error	Charger Output Curve Error shutdown
12-Didt	Rising Current/Falling Voltage Error shutdown
13-Lvsd	Low Charging Voltage Error shutdown
14-Ahsd	Excessive AH Returned Error shutdown
15-BID Read	BID Error Shutdown

10. EQUALIZE TIME

The time of the equalize portion of the charge cycle. Equalize can be automatically or manually selected.

11. START TIME

The time at the start of the charge cycle (AM/PM format).

12. END TIME

The time at the end of the charge cycle. Includes the equalize time if it was automatically or manually selected (Military format).

13. TRUCK I.D.

The Truck I.D. number of the truck that the battery was discharged in prior to the charge cycle. Requires Prestolite Truck and Battery Identification Modules (TID and BID).

14. BATTERY I.D.

The Battery I.D. number of the battery that was charged in the charge cycle. Requires Prestolite Battery Identification Module (BID).

15. BATTERY VOLTS

The present voltage of the battery connected to the battery charger (volts DC).

16. FAN RUN HOURS (k)

The number of hours (thousands) that the charger fan (if equipped) has run.

17. BID START TEMP

The temperature of the battery sensed by the Prestolite Battery Identification Module at the start of the charge cycle (degrees F).

18. BID END TEMP.

The temperature of the battery sensed by the Prestolite Battery Identification Module at the end of the charge cycle (degrees F).

19. PRESENT TIME

The present time (AM/PM format).

20. WEEK DAY

The present day of week (SUN through SAT).

21. EQUALIZE TYPE

The type of auto equalize selected. The types that can be selected are listed below:

CYC. = By cycle count (see AUTO EQ. COUNT).

D.O.W. = By the day of week (see Auto EQ. Day).

BID = By BID count

22. EQUALIZE CYCLES

The number of charge cycles between equalize charges when the auto equalize function is programmed "ON" and the auto equalize type is set to "COUNT".

23. EQ. DAY

The day of the week that an equalize charge cycle is performed when the auto equalize function is "ON" and the auto equalize type is set to "DAY".

24. AUTO EQUALIZE

Shows the auto equalize function on or off.

Auto equalize "OFF"

Auto equalize "ON"

25. T.O.D. START

Time of day start time. (AM/PM). See START MODE.

26. DELAYED START

Delayed start time interval. (00H 00M to 23H 59M). See START MODE.

27. BLOCK START

The beginning time of the time of day blackout function (AM/PM). See START MODE

28. BLOCK END

The ending time of the time of day blackout function. (AM/PM). See START MODE.

29. START OVERRIDE

The start override function that allows the operator to override any of charger start modes (i.e. delayed start, time of day start, or time of day blockout) by pressing the ENTER key.

30. START MODE

Shows the selected start mode for the start of the charge cycle.

- AUTO = Automatic mode
- T.O.D.S. = Time of day start mode
- DELAYED = Delay start mode
- T.O.D.B. = Time of day blockout
- TIMER = Timer Mode

31. FORMING CYCLES

The number of forming cycles for a new battery by disabling the low current shutdown, and setting VT Termination mode for the programmed number of cycles (00 to 30).

WARNING: Enabling the Finish Cell Forming feature will cause the charger to continue to run for a period of time if the battery has been disconnected before Charge Complete or pressing the Manual Stop key. This condition will continue until the programmed number of cycles have been completed. The battery should never be disconnected while a charge is in progress.

32. SPECIAL OPTION

Special option modes see below.

- OFF
- "P.T.S." = Push to start mode.

The charger will not start until the "ENTER" key is pressed.

- F.L.O. = Fault lockout mode.

The charger will not restart until any faults are reset by pressing the "ENTER" key with no battery connected.

33. CYC. AMP HOURS

The ampere-hour setting of the charger during the charge cycle. This value cannot exceed the maximum charger output rating.

34. CYCLE CELLS

The cell size setting of the charger during the charge cycle. This value cannot exceed the maximum charger output rating.

35. FIXED CELL SIZE

The cell size the charger will operate at if the "multi-cell mode" is not selected and the charger does not detect a Prestolite BID module. See "MULTI-CELL MODE".

36. FIXED AMP HRS

The ampere-hour size the charger will operate at if the charger does not detect a Prestolite BID module.

37. FIX.BAT.TEMP.

The battery temperature used for charger output voltage compensation, if the charger does not detect a Prestolite BID Module (032 to 132°F).

CAUTION: Do Not Exceed the Battery Manufacturer's Maximum allowed Battery temperature.

38. BATTERY TYPE

The battery type the charger uses to select the proper output voltage and current characteristic, if the charger does not detect a Prestolite BID.

- FLD = Standard flooded lead acid industrial type battery curve.
- CTM. = Custom curve. Uses the voltage and current values programmed in the STRT A/100 A.H., FIN. A/100A.H., GAS. V/C., and LID. V/C.
- YGR }
SLR } = Sealed lead acid battery curves
DSG }
SLE }
DAG }
CDR }

MAX = Opportunity Charge Curve

*MAH will be displayed if the Multi-Amp Hour Feature is turned on.

39. START AMPS/100

The selected output curve start current setting (10.0 to 16.3 amps per 100 ampere-hours).

40. FINISH AMPS/100

The selected output curve finish current setting (0.0 to 7.9 amps per 100 ampere-hours).

41. GASSING V/C

The selected output curve gassing voltage level setting (2.00 to 2.99 volts/cell).

42. LID. V/C

The selected output curve lid voltage setting (2.00 to 2.99 volts/cell).

43. CHARGER I.D.

The battery charger identification number. This must be set to 0000 unless the battery charger is part of a Prestolite CDAC system. (0000 to 9999)

Factory setting = 0000

44. REFRESH DELAY

The number of hours before the charger automatically starts and refresh charges a battery that has not been disconnected (8 to 99 hours).

Factory Setting = 72 hours.

45. DVDT DISABLE

Disables the automatic DV/DT charge termination feature and enables Voltage Time charge termination.

OFF = (DV/DT Mode)

ON = (VT mode)

46. PRESENT MONTH

The current month (1 to 12)

47. PRESENT DATE

The current day of the month (1 to 31).

48. PRESENT YEAR

The current year (00 to 99).

49. MULTICELL MODE

Enables the automatic cell selection mode of operation for the charger. When turned off, the charger operates at the Fixed cell size (see FIX. CELL SIZE).

50. COOL DOWN HOURS

The number of hours cool down from the end of charge until charge complete is indicated by the charger (0 to 8).

51. BID CELLS

If a connected battery is equipped with a Battery I.D. module, the battery cells size (6,9,12,18,24,36) may be reprogrammed into the BID. The control must be in "Manual Stop" status.

52. BID NUMBER

If a connected battery is equipped with a Battery I.D. module, the I.D. number (001-999) may be re-programmed into the BID. The control must be in "Manual Stop" status.

53. BID AMP HOURS

If a connected battery is equipped with a Battery I.D. module, the battery amp-hour size (0000-9999) may be reprogrammed into the BID. The control must be in "Manual Stop" status.

54. BID BATTERY TYPE

If a connected battery is equipped with a Battery I.D. module, the battery type may be programmed into the BID. The control must be in "Manual Stop" status.

00	FLD	Flooded Lead Acid
01	CTM	Custom curve (programmable)
02	YGR	Sealed battery curve
03	SLR	Sealed battery curve
04	DSG	Sealed battery curve
05	SLE	Sealed battery curve
06	DAG	Sealed battery curve
07	CDR	Sealed battery curve
08	MAX	Opportunity Charge curve

55. PASSWORD

Optional password required to program if turned on.

56. NO GASSING HOURS

The number of Hours before the charger can begin the gassing portion of the charging cycle. (0 – 8 Hours)

57. MAX BATT TEMP

The maximum battery temperature for charging to start or continue. Once interrupted, the charge will restart after the temperature drops 5 degrees F. (For use with BID only)

58. CYCLE KWH

The number of kilowatt hours used during the last charge cycle.

59. BID START AMPS

Programs the charger start rate at the programmed BID AH rating to the selected amps/100AH. For example, to charge an 800AH battery at 320 amps, the "BID Start Amps" would be programmed to 40A/100AH. Please note that if the programmed rate exceeds the maximum rated charger amps, the charger output will be limited to the maximum current rating.

60. BATTERY CHARGE AMP HOURS

The accumulated amp hours charged into the battery. An Amp Hour Accumulator and BID module assembly must be installed on the battery to use this function. The Amp Hour Accumulator continually records this data while it is installed on the battery.

The data is automatically read from the bid when the control terminates each charge cycle, except for Manual Stop. The data is stamped with the date and BID number.

61. BATTERY DISCHARGE AMP HOURS

The accumulated amp hours discharged from the battery. An Amp Hour Accumulator and BID module assembly must be installed on the battery to use this function. The Amp Hour Accumulator / BID continually records this data while it is installed on the battery.

The data is automatically read from the bid when the control terminates each charge cycle, except for Manual Stop. The data is stamped with the date and BID number.

62. LONG TERM AVERAGE BATTERY TEMPERATURE

The average BID temperature of the battery. An Amp Hour Accumulator and BID module assembly must be installed on the battery to use this function. The BID continually updates the average while it is installed on the battery.

The data is automatically read from the bid when the control terminates each charge cycle, except for Manual Stop. The data is stamped with the date and BID number.

63. BATTERY CYCLES

The number of battery discharge cycles, based on the total discharge amp hours and 80% of the BID amp hour setting. An Amp Hour Accumulator and BID module assembly must be installed on the battery to use this function. The control continually updates this calculation using the total accumulated discharge amp hours read in from the BID.

64. CHARGE/DISCHARGE RATIO

The ratio of the total charge amp hours over the total discharge amp hours. An Amp Hour Accumulator and BID module assembly must be installed on the battery to use this function. The control continually updates this calculation using the total accumulated charge and discharge amp hours read in from the BID.

Standard Chargers

65. FIXED START AMPS

(Opportunity/Fast charging without a BID)

Programs the charger start rate at the programmed charger AH setting to the selected amps/100AH. For example, to charge an 800AH battery at 320 amps, the "battery start amps" would be programmed to 40A/100AH. *Please note that if the programmed rate exceeds the maximum rated charger amps, the charger output will be limited to the maximum current rating.*

40 Cell Chargers

65. MAX CELL SIZE

Programs the Max Cell Size available on 40 cell Chargers in the multi-cell mode. The charger cannot automatically recognize the difference between 40 and 36 cell sizes and therefore, the Max Cell Size in that mode must be programmed to 36 or 40 cells. Regardless of this setting, 36 or 40 cell batteries with properly programmed Prestolite BID modules will correctly be charged.

36 = 36 Cells
40 = 40 Cells

66. FIXED START AMPS (Opportunity/Fast charging without a BID)

Programs the charger start rate at the programmed charger AH setting to the selected amps/100AH. For example, to charge an 800AH battery at 320 amps, the "battery start amps" would be programmed to 40A/100AH. *Please note that if the programmed rate exceeds the maximum rated charger amps, the charger output will be limited to the maximum current rating.*

ULTRA MAXX ARCHIVE, REVIEW & PROGRAMMING MENU STRUCTURE

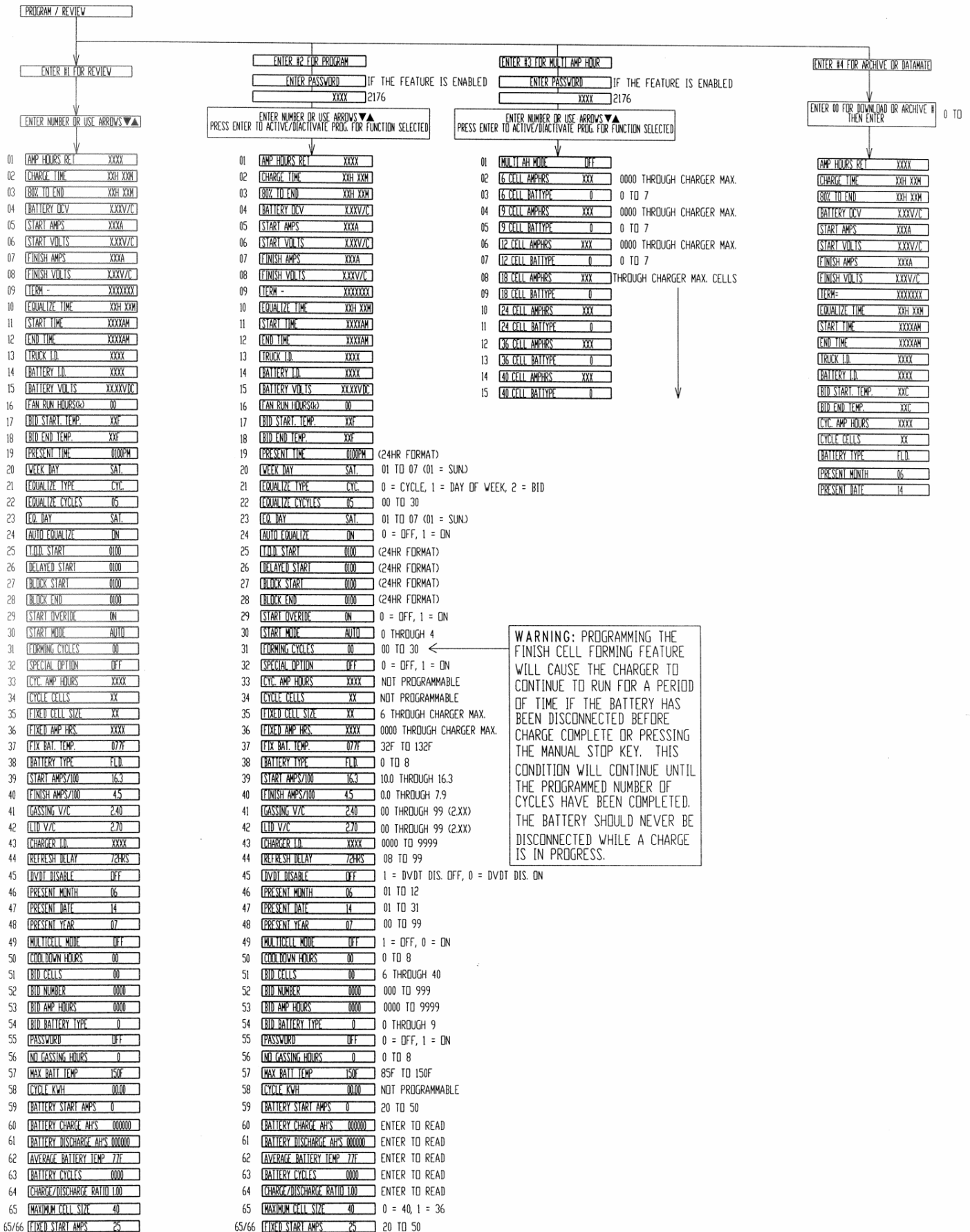

WARNING: PROGRAMMING THE FINISH CELL FORMING FEATURE WILL CAUSE THE CHARGER TO CONTINUE TO RUN FOR A PERIOD OF TIME IF THE BATTERY HAS BEEN DISCONNECTED BEFORE CHARGE COMPLETE OR PRESSING THE MANUAL STOP KEY. THIS CONDITION WILL CONTINUE UNTIL THE PROGRAMMED NUMBER OF CYCLES HAVE BEEN COMPLETED. THE BATTERY SHOULD NEVER BE DISCONNECTED WHILE A CHARGE IS IN PROGRESS.

Figure 7-2

Programming Your UC2000 Control

The programming function allows 38 functions to be programmed to customize your Prestolite ULTRA MAXX to your battery charging application. Programming is not available during an active charge cycle, and can only be accessed before battery connect or after charge termination.

All programmable functions are keyed with the sequence shown below. To prevent unauthorized access, use the optional password feature. Any single programming item can be accessed by entering its function number at the prompt or by using the arrow keys to scroll to the item. If the password feature is used and the improper number is entered, the control will reject access to programming and display "Password Failed". The sequence may then be started over.

Keys	Display
Program/Review	Enter → 1-REV 2-PROG Function 3-MAH 4-ARCH
2	Enter Prog Func #

Enter password if required. Key in function number or scroll using arrow keys to reach the desired programming function (see Figure 7-2).

Once the desired function is reached, press the "enter" key to enable programming. Functions 33/34 and 58 are not programmable. On functions with several numeric data fields, the display will show "Enter Numeric Value". The flashing digit will change as the entries are keyed in. Press the "Enter" key again when programming of that function is complete. On functions with 1 or 2 data places, the display will show "Δ ▽ to Change Data". Use the arrow keys to increment or decrement the data. Again press the "Enter" key when programming of that function is complete.

19. PRESENT TIME

The current time. Program in 24 hour military time format (0000 to 2359 military time).

20. WEEK DAY

The present day of week (SUN through SAT).

Use the up or down arrow to select the proper setting.

21. EQUALIZE TYPE

The type of auto equalize selected. The types that can be selected are listed below.

By cycle count (see AUTO EQ. COUNT).
Factory setting.

By the day of week (see AUTO EQ. DAY).

By BID cycle count

Use the up or down arrow to select the proper setting.

22. EQUALIZE COUNT

The number of complete charge cycles between equalize charges when the auto equalize function is programmed "ON" and the auto equalize type is set to "COUNT" or "BID".

05 = factory setting

Use the up or down arrow to select the proper setting.

23. EQ. DAY

The day of the week that an equalize charge cycle is performed when the auto equalize function is "ON" and the auto equalize type is set to "DAY".

Saturday = factory setting

Use the up or down arrow to select the proper setting.

24. AUTO EQUALIZE

Sets the auto equalize function on or off.

Auto equalize "ON" = Factory Setting

Use the up or down arrow to select the proper setting.

25. T.O.D. START

Sets the time of day start time (0000 to 2359 military time). See START MODE.

26. DELAYED START

Sets the delayed start time interval (00H 00M to 23H 59M)

Factory = 00H 00M. See START MODE

27. BLOCK START

Sets the beginning time of the time of day blackout function (0000 to 2359 military time). See START MODE.

28. BLOCK END

Sets the ending time of the time of day blackout function (0000 to 2359 military time). See START MODE.

29. START OVERRIDE

Sets the start override function that allows the operator to override any of the charger start modes (i.e.; delayed start, time of day start, or time of day blackout).

On = Factory setting

Use the up or down arrow to select the proper setting.

30. START MODE

Selects the desired start mode for the start of the charge cycle.

Automatic mode	"AUTO" factory setting
Time of day start mode	"T.O.D.S."
Delay start mode	"DEL.S."
Time of day blackout	"T.O.D.B."
Timer	TIMER MODE

Use the up or down arrow to select the proper setting.

31. FORMING CYCLES

Sets the number of forming cycles for a new battery by disabling the low current shutdown and setting VT Termination mode for the programmed number of cycles (00 to 30).

00 = Factory Setting

Use the up or down arrow to select the proper setting.

WARNING: Enabling the Finish Cell Forming feature will cause the charger to continue to run for a period of time if the battery has been disconnected before Charge Complete or pressing the Manual Stop key. This condition will Continue until the programmed number of cycles have been completed. The battery should never be disconnected while a charge is in progress.

32. SPECIAL OPTION

Sets special option modes, see below:

OFF factory setting
"P.T.S." Push to start mode

The charger will not start until the "ENTER" key is pressed.

"F.L.O." Fault lockout mode

The charger will not restart until any faults are reset by pressing the "ENTER" key and no battery is connected.

Use the up or down arrow to select the proper setting.

33. CYC. AMP HOURS

The ampere-hour setting of the charger during the last charge cycle. This value cannot exceed the maximum charger output rating. **Not programmable.**

34. CYCLE CELLS

The cell size setting of the charger during the last charge cycle. This value cannot exceed the maximum charger output rating. **Not programmable.**

35. FIXED CELL SIZE

The cell size the charger will operate at if the "multi-cell mode" is not selected and the charger does not detect a Prestolite BID module. See "MULTI-CELL MODE".

Factory setting = nameplate rating

06 = 6 cells	} only available on 36 & 40 cell units
09 = 9 cells	
12 = 12 cells	
18 = 18 cells	
24 = 24 cells	
36 = 36 cells	
40 = 40 cells	

NOTE: Maximum setting is the charger Nameplate rating.

36. FIXED AMP HRS.

The ampere-hour size the charger will operate at if The charger does not detect a Prestolite BID module (0001 to nameplate rating).

Factory Setting = nameplate rating

NOTE: Maximum setting is the charger Nameplate rating.

37. FIX. BAT. TEMP.

The battery temperature used for charger output voltage compensation, if the charger does not detect a Prestolite BID module (032 to 132°F).

77° = Factory Setting

CAUTION: Do Not Exceed the Battery Manufacturer's Maximum allowed Battery temperature.

38. BATTERY TYPE

The battery type the charger uses to select the proper output voltage and current characteristic, if the charger does not detect a Prestolite BID.

- 0 = FLD Standard flooded lead acid industrial type battery curve. Factory setting
- 1 = CTM. Custom Curve. Uses the voltage and current values programmed in the STRT. A/100A.H., FIN. A/100A.H., GAS. V/C, and LID. V/C.
- 2 = S.L.A. Sealed Lead Acid battery curve
- 3 = S.L.R. A charge curve that meets the requirements of some AGM (Absorbed Glass Mat) Type Lead Acid Batteries
- 4 = D.S.G. Sealed Lead Acid battery charge curve that meets requirements of the EPM "DEKA" Sealed Lead Acid battery.
- 5 = S.L.E. Sealed Lead Acid battery curve
- 6 = D.A.G. Sealed Lead Acid battery curve
- 7 = C.D.R. Sealed Lead Acid battery curve
- 8 = MAX Opportunity Charge curve

Use the up or down arrow to select the proper setting.

NOTE: Functions 39 through 42 apply only to the custom curve and cannot be changed unless the custom curve has been selected in Function 38.

39. START AMPS/100

The custom output curve start current setting (10.0 to 16.3 amps per 100 ampere-hours).

Factory setting = 16.3

40. FINISH AMPS/100

The custom output curve finish current setting (0.0 to 7.9 amps per 100 ampere-hours).

Factory Setting = 4.5

NOTE: For Functions 41 and 42, only information to the right of the decimal point can be entered.

41. GASSING V/C.

The custom output curve gassing voltage level setting (2.00 to 2.99 volts/cell).

Factory setting = 2.40

42. LID. V/C.

The custom output curve lid voltage setting (2.00 to 2.99 volts/cell).

Factory setting = 2.70

43. CHARGER I.D.

The battery charger identification number. This must be set to 0000 unless the battery charger is part of a Prestolite CDAC system (0000 to 9999).

Factory setting = 0000

44. REFRESH DELAY

The number of hours before the charger automatically starts and refresh charges a battery that has not been disconnected (8 to 99 hours).

Factory setting = 72 hours.

45. DVDT DISABLE

Disables the automatic DV/DT charge termination feature and enables Voltage Time charge termination.

OFF (DV/DT mode) factory setting
ON (VT mode)

Use the up or down arrow to select the proper setting.

46. PRESENT MONTH

The current month (1 to 12).

47. PRESENT DATE

The current day of the month (1 to 31).

48. PRESENT YEAR

The current year (00 to 99).

49. MULTICELL MODE

Enables the automatic cell selection mode of operation for the charger. When turned off the charger operates at the Fixed Cell Size (see FIXED CELL SIZE).

OFF
ON Factory Setting

Use the up or down arrow to select the proper setting.

50. COOL DOWN HOURS

The number of hours cool down from the end of charge until charge complete is indicated by the charger (0 to 8).

0 = factory setting.

Use the up or down arrow to select the proper setting.

BID Programming

The following conditions must be met before a Prestolite BID can be programmed or reprogrammed with this charger.

- a. A battery with the correct cell size BID must be connected to the charger.
- b. The charger must be in the Manual Stop condition
- c. The control must be set to the programming menu and functions 51 thru 54 must be selected.

After the above conditions are met the BID can be properly programmed.

After a number entry is keyed in, the control will immediately attempt to program it in the BID while displaying "WRITING BID". If the entered number is out of range or is not accepted by the BID, the control will return to the original prompt with all 0's displayed for the entered data. If the BID properly accepts the data, the programmed number will be returned to the display.

51. BID CELLS

Programs the Cell Size into the BID. Once programmed the charger will recognize the battery upon connection, bypass the battery cell size verify function, and charge to the programmed BID cell size.

- 06 = 6 Cells
- 09 = 9 Cells
- 12 = 12 Cells
- 18 = 18 Cells
- 24 = 24 Cells
- 36 = 36 Cells
- 40 = 40 Cells

52. BID NUMBER

Programs the battery identification number into the BID. (000 to 999)

53. BID AMP HOURS

Programs the battery ampere hour rating into the BID. Once programmed the charger will recognize the battery upon connection and charge the battery at the proper charge rates or the max charger output, whichever is greater. (0000 to 9999)

54. BID BATTERY TYPE

Programs the battery type into the BID. Once programmed, the charger will recognize the battery type upon connection, and charge the battery with the proper curve.

- 0 = Flooded Curve
- 1 = Custom Curve
- 2 = Sealed Lead Acid Curve
- 3 = Sealed Lead Recombinant Curve Absorbed Glass Mat (AGM) Types
- 4 = Sealed Lead Acid Curve ("DEKA" and Other Gel Types)
- 5 = Sealed Lead Acid Curve
- 6 = Sealed Lead Acid Curve
- 7 = Sealed Lead Acid Curve
- 8 = Ultra Maxx/Equinox Curve (Opportunity Charge curve)

55. PASSWORD

- OFF = Factory Setting
- On = Password Enabled

Use the up or down arrow to select the proper setting.

56. NO GASSING HOURS

The number of Hours before the charger can begin the gassing portion of the charging cycle. (0 – 8 hours)

Factory setting = 00 hours

Use the up or down arrow to select the proper setting.

57. MAX BATT TEMP

The maximum battery temperature for charging to proceed. (For use with BID only)
(080 to 150 degrees F)

Factory setting = 150

58. CYCLE KWH

The number of kilowatt hours returned during the last charge cycle. **Not Programmable.**

59. BID START AMPS

Programs the charger start rate at the programmed BID AH rating to the selected amps/100AH. For example, to charge an 800AH battery at 320 amps, the "BID Start Amps" would be programmed to 40A/100AH. *Please note that if the programmed rate exceeds the maximum rated charger amps, the charger output will be limited to the maximum current rating*

60. BATTERY CHARGE AMP HOURS

The accumulated amp hours charged into the battery. An Amp Hour Accumulator and BID module assembly must be installed on the battery to use this function. The Amp Hour Accumulator continually records this data while it is installed on the battery.

The data is automatically read from the bid when the control terminates each charge cycle, except for Manual Stop. The data is stamped with the date and BID number.

Read the data "on demand" by pressing the "Stop" key. *

Press and hold the "Equalize" button for 10 seconds to reset all data. *

61. BATTERY DISCHARGE AMP HOURS

The accumulated amp hours discharged from the battery. An Amp Hour Accumulator and BID module assembly must be installed on the battery to use this function. The Amp Hour Accumulator / BID continually records this data while it is installed on the battery.

The data is automatically read from the bid when the control terminates each charge cycle, except for Manual Stop. The data is stamped with the date and BID number.

Read the data "on demand" by pressing the "Stop" key. *

Press and hold the "Equalize" button for 10 seconds to reset all data. *

62. LONG TERM AVERAGE BATTERY TEMPERATURE

The average BID temperature of the battery. An Amp Hour Accumulator and BID module assembly must be installed on the battery to use this function. The BID continually updates the average while it is installed on the battery.

The data is automatically read from the bid when the Control terminates each charge cycle, except for Manual Stop. The data is stamped with the date and BID number.

Read the data "on demand" by pressing the "Stop" key. *

Press and hold the "Equalize" button for 10 seconds to reset all data. *

***The control must be in Manual Stop mode.
Note that all data is read in, Charge AH, discharge AH and average temperature when reading in the "on demand" mode.**

63. BATTERY CYCLES

The number of battery discharge cycles, based on the total discharge amp hours and 80% of the BID amp hour setting. An Amp Hour Accumulator and BID module assembly must be installed on the battery to use this function. The Control continually updates this calculation using the total accumulated discharge amp hours read in from the BID. **NOT PROGRAMMABLE**

64. CHARGE/DISCHARGE RATIO

The ratio of the total charge amp hours over the total discharge amp hours. An Amp Hour Accumulator and BID module assembly must be installed on the battery to use this function. The control continually updates this calculation using the total accumulated charge and discharge amp hours read in from the BID. **NOT PROGRAMMABLE**

Standard Chargers**65. FIXED START AMPS (Opportunity/Fast charging without a BID)**

Programs the charger start rate at the programmed charger AH setting to the selected amps/100AH. For example, to charge an 800AH battery at 320 amps, the "battery start amps" would be programmed to 40A/100AH. *Please note that if the programmed rate exceeds the maximum rated charger amps, the charger output will be limited to the maximum current rating.*

Factory Setting = 25

40 Cell Chargers**65. MAX CELL SIZE**

Programs the Max Cell Size available on 40 cell chargers in the multi-cell mode. The charger cannot automatically recognize the difference between 40 and 36 cell sizes and therefore the Max Cell Size in that mode must be programmed to 36 or 40 cells. Regardless of this setting 36 or 40 cell batteries with properly programmed Prestolite BID modules will correctly be charged.

36 = 36 Cells

40 = 40 Cells

Use the up or down arrow to select the proper setting.

NOTE: The Max Cell Size function is available on 40 cell charge models only.

66. FIXED START AMPS**(Opportunity/Fast charging without a BID)**

Programs the charger start rate at the programmed charger AH setting to the selected amps/100AH.

For example, to charge an 800AH battery at 320 amps, the “battery start amps” would be programmed to 40A/100AH. *Please note that if the programmed rate exceeds the maximum rated charger amps, the charger output will be limited to the maximum current rating.*

Factory Setting = 25

Using Extended AH for Opportunity/ Fast Charging on the ULTRA-MAXX

The Extended AH Feature of the Ultra-Maxx allows the user to Opportunity/Fast Charge batteries at charge rates from 20-50A/100AH, as long as the actual charge current is within the nameplate rating of the charger. Batteries that are rated below the maximum AH rating of the charger can be Opportunity/Fast charged at rates higher than the nominal 25A/100AH.

Using a BID

When a BID is installed on the battery, it must have the “Battery Start Amps” set to a value between 20 and 50. The charger will then supply a start current equal to the Battery Start Amps setting times the AH rating of the battery that is programmed in the BID divided by 100. See the example below:

Battery 24 cell, 600AH (24-100-13)
Charger 1045T3-24UMF

BID Settings:

BID Cells 24 (item 51)
BID AH 0600 (item 53)
BID Battery Type 08 (item 54)
BID Start Amps 40 (item 59)

Resulting Charge Rates:

Start Amps - $6 \times 40 = 240$ Amps
Finish Amps - $4.5 \times 6 = 27A$
Charger rated start amp = 261

Not using a BID

The example below describes how to accomplish Extended amp-hour charging without the use of BID Module on the battery.

Battery 24 cell, 600AH (24-100-13)
Charger 1045T3-24UMF

Charger settings:
Charger Fixed AH 0600 (Function 36)
Charger Curve Type 08 (Function 38)
Fixed Start Amps 40 (Function 66)

Resulting Charge Rate:

Start Amps — $6 \times 40 = 240$ Amps
Finish Amps — $4.5 \times 6 = 27$ Amps
Charger rated start amp = 261

Multi AmpHour Programming Your UC2000 Control

The Multi AH Feature of the UC2000 Control allows the user to customize his Ultra-Maxx to fit his multi-battery application. Using this feature, the flexibility of the Ultra Maxx can be used to charge batteries of different Amp Hour capacities and types without using Battery Identification Modules (BIDs) or different chargers with different plug types.

The control can be programmed to charge different voltage batteries with the AH rates and curve types that have been programmed for that battery voltage. When a battery is connected, the control automatically senses the battery voltage and sets the charge curve and charging rates to the level that has been programmed.

The Multi AH functions are programmed through a separate menu item on the control. Complete steps for programming a typical application are listed to the right.

Application

6 cell, 450AH Gel Type Maintenance Free
12 cell, 680AH Flooded
18 cell, 744AH Flooded
785T3-18 Ultra-Maxx

With the control programmed as shown to the right, the control will charge any 6 cell battery that is connected to the charger at the proper 450AH rates for a *Deka Dominator* Sealed Gel Battery. Any 12 cell battery connected to the charger will be charged at the proper 680AH rates for a standard flooded battery. Finally, any 18 cell battery connected to the charger will be charged at the proper 744AH rates for a standard flooded battery.

By enabling the Multi AH function, any 6,9,12,18,24, and/or 36 cell battery that is equal to or less than the charger rated voltage can be charged at a unique AH rate and with a unique charge curve. For example, 785T3-24 can be programmed to charge 6,9,12,18 and 24 cell batteries with different AH rates and/or different charge curves.

<u>Key Entry</u>	<u>Display</u>
	Ultra Maxx
Program Review	Menu Tree 1 – 4
3	Multi AH Mode OFF
Enter	Multi AH Mode OFF
▲	Multi AH Mode ON
Enter	Multi AH Mode ON
▼	6 Cell Amphrs 0750
Enter	6 Cell Amphrs 0750
0450	6 Cell Amphrs 0450
Enter	6 Cell Amphrs 0450
▼	6 Cell Battype▶ FLD
Enter	6 Cell Battype▶ FLD
4	6 Cell Battype▶ DSG
Enter	6 Cell Battype▶ DSG
▼	9 Cell Amphrs 0750
▼	9 Cell Battype▶ FLD
▼	12 Cell Amphrs 0750
Enter	12 Cell Amphrs 0750
0680	12 Cell Amphrs 0680
Enter	12 Cell Amphrs 0680
▼	12 Cell Battype▶ FLD
▼	18 Cell Amphrs 0750
Enter	18 Cell Amphrs 0750
0744	18 Cell Amphrs 0744
Enter	18 Cell Amphrs 0744
▼	18 Cell Battype▶ FLD
Program Review	Menu Tree 1 – 4
Program Review	Ultra Maxx

Timer Start Mode Programming Your UC2000 Control

The Timer Start Mode Feature of the UC2000 Control allows the user to override the automatic start/stop features of the control and manually select the desired charge time. This can be useful for charging batteries in a maintenance shop, or for extended equalize charging of batteries with severely mismatched cells.

The Timer Start Mode can be programmed in the Program Menu at Start Mode (function #30). With the Timer Start Mode selected the charger will display CHG CYCLE TIME when a battery is connected. Charge times from 0 hours, 1 minute, to 23 hours, 59 minutes can be entered. Pressing the Enter key will start the charge. The charger will then charge the connected battery based on the any parameters that have been programmed into the control. For example, **constant current charging** can be achieved utilizing the custom curve programming in conjunction with the Timer Start Mode. Listed to the right is an example of programming an Ultra Maxx to constant current charge a battery for 20 hours at a 5 amp/100AH rate.

Application

24-Cell 935AH Battery
1045T3-24 Ultra-Maxx

When programmed and connected as shown to the right, the charger will charge the battery at 48 amps for 20 hours before automatically shutting off.

It should be noted that any programming that is done to set up a special charge (such as Timer Start Mode, Custom Curve, etc.) must be reset to allow resumption of normal charging.

Key Entry	Display
	Ultra Maxx
Program Review	Menu Tree 1 – 4
2	Present Time 12:34
30	Start Mode Auto
Enter	Start Mode Auto
▲▲▲▲	Start Mode Timer
Enter	Start Mode Timer
36	Fixed Amp Hrs. 1050
Enter	Fixed Amp Hrs. 1050
0935	Fixed Amp Hrs. 0935
Enter	Fixed Amp Hrs. 0935
38	Battery Type FLD
Enter	Battery Type FLD
1	Battery Type CTM.
Enter	Battery Type CTM.
▼▼	Finish Amps/100 4.5
Enter	Finish Amps/100 4.5
50	Finish Amps/100 5.0
Enter	Finish Amps/100 5.0
▼	Gassing V/C 2.40
Enter	Gassing V/C 2.40
00	Gassing V/C 2.00
Enter	Gassing V/C 2.00
▼	Lid V/C 2.70
Enter	Lid V/C 2.70
99	Lid V/C 2.99
Enter	Lid V/C 2.99
Program Review	Menu Tree 1 – 4
Program Review	Ultra Maxx

On battery connection, the control will ask for the cycle charging time to be entered. Key in 20 hours and press the “enter” key.

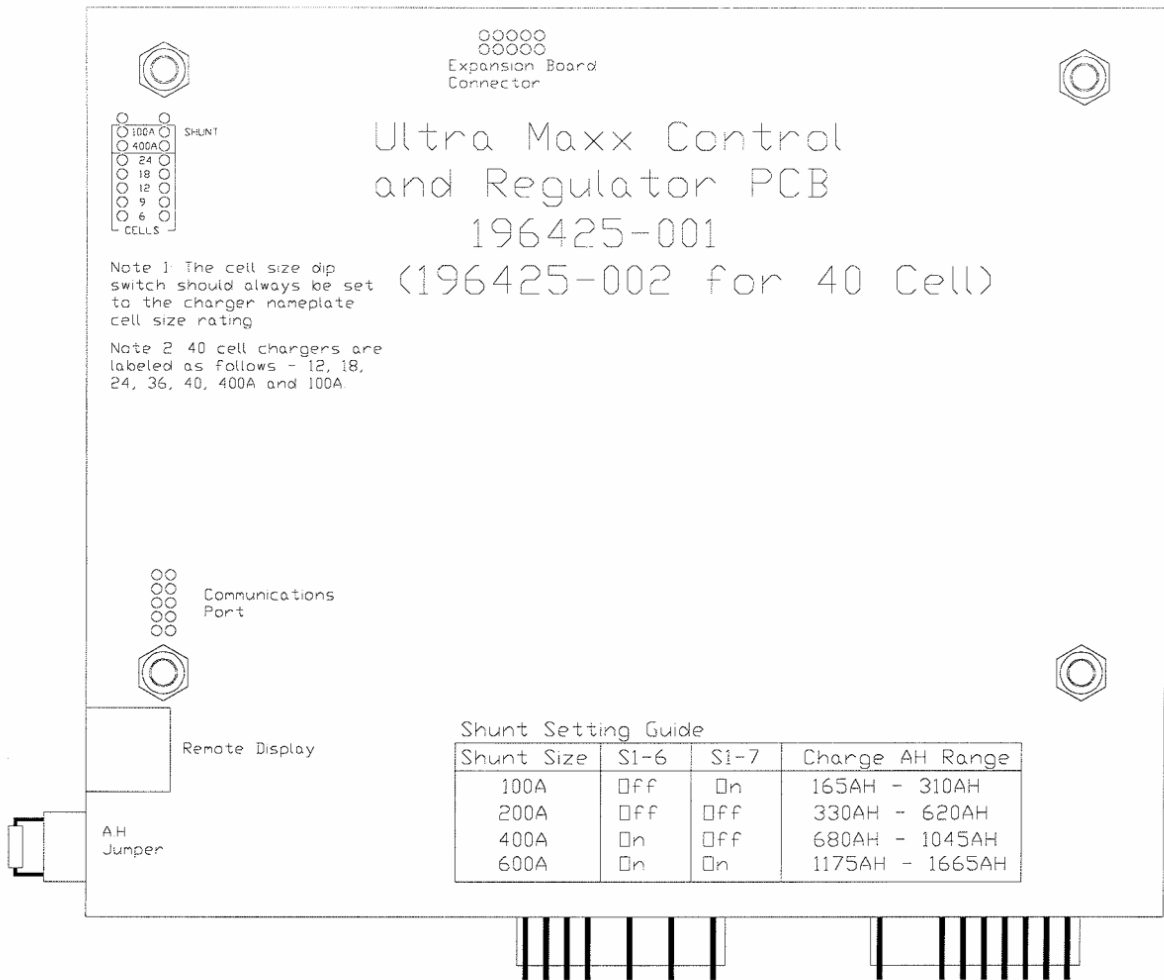

Charger AH	Res. Value	P/N
425	6.34K	192302-005
555	10.7K	192302-004
680	4.32K	192302-001
785	5.76K	192302-002
910	7.32K	192302-008
1045	9.76K	192302-009
1270	6.34K	192302-005

Figure 8-1

OPTIONS

The options listed in the following table of contents are those most commonly available. Special options not listed here will be covered by enclosed "addendum" sheets.

OPTION DESCRIPTION	PAGE
Parallel Charging	9-1
Series Charging	9-1
Fused Disconnect Switch and 24-V Control Circuit	9-2

Parallel Charging

This option provides cables allowing two batteries to be charged at the same time (batteries connected in parallel to charger).

To prevent premature charger turn on, this option requires the use of a battery connector with auxiliary contacts (Anderson "SBX" or equivalent). The same type connector must be specified on the battery and vehicle. The connector on the battery must have the auxiliary contacts jumpered together.

NOTE: The safety interlock circuit is protected by an in-line 1 Amp AGC Fuse inside the battery charger.

When charging two batteries, each must be of the same voltage (or number of cells). The total rated ampere-hour capacity of both batteries plus the voltage (number of cells of only one of the batteries) must be within the range of the charger. Refer to charger nameplate for ratings. For example: two 12-volt (6 cell), 225 ampere-hour batteries would make a 12-volt (6 cell), 450 ampere-hour load.

Operate this charger as instructed in Operation chapter of this manual except that batteries are to be connected as shown in Figure 9-1, plus the total ampere-hour capacity must be used to calculate charging time.

CAUTION: Make sure all connections are made positive to positive and negative to negative as shown.

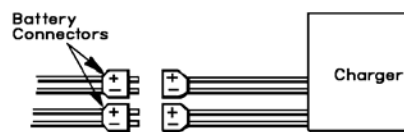

Figure 9-1 Parallel Charging Connections

- No. 1/0 size cable for 555-680 AH.....P/N 397891-4
- No. 2/0 size cable for 681-910 AH.....P/N 397891-5
- No. 3/0 size cable for 911-1050 AH.....P/N 397891-6
- No. 4/0 size cable for 1051-1270 AH.....P/N 397891-7

Series Charging

This option provides a cable allowing two batteries to be charged at the same time (batteries connected in series to charger).

- Series cables for 555-680 AH.....P/N 396820-4
- Series cables for 681-910 AH.....P/N 396820-5
- Series cables for 911-1050AH.....P/N 396820-6
- Series cables for 1051-1270AH.....P/N 396820-9

CAUTION: With the batteries required to be connected in series, this charger cannot be used to charge one battery only.

Both batteries must be of the same ampere-hour rating. The total rated voltage (or number of cells) of both batteries (add the two), plus the ampere-hour capacity of only one battery, must be within the charger name-plate range ratings. For example: two 12-volt (6 cell), 450 ampere-hour batteries would make a 24-volt (12-cell), 450 ampere-hour load.

NOTE: For series charging, both batteries must be at identical depths of discharge (DOD); i.e., they are used in series in the vehicle. A mismatch in DOD of the two batteries will result in severe overcharge of the lightly discharged battery and severe undercharge of a deeply, discharged battery.

Operate this charger as instructed in Operation chapter of this manual, except that charger must be connected to both batteries instead of just one. Refer to Figure 9-2.

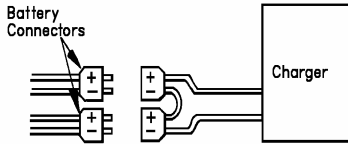

Figure 9-2 Series Charging Connections

CAUTION: Make sure all connections are made positive to positive and negative to negative as shown.

Extra Length Output Cables

	5 Ft Extra	10 Ft Extra
No. 1/0 size for 555-680AH	396143-64	396143-67
No. 2/0 size for 681-785AH	396143-65	396143-68
No. 3/0 size for 786-1050AH	396143-75	396143-78
No. 4/0 size for 1051-1270AH	396143-76	396143-88

Fused Disconnect Switch

(Refer to Figure 9-3)

To order "JIC" disconnect chargers, add "-002" to the base Spec No. Example:
 680T3-12UM w/Opt. 500 = Spec 500659-002

This option is provided to meet certain "JIC" requirements. The switch must be in the open (OFF) position to disconnect all AC power going into the charger and to allow front door to be opened. With switch in open position, door can be opened by turning slotted latch screw to the left.

Disconnect switch is for *emergency or service use* only.

Charge cycle should continue until automatically shut off. If cycle must be interrupted, press the "STOP" key. A control circuit operating on 24 volts is also provided to help assure operator safety.

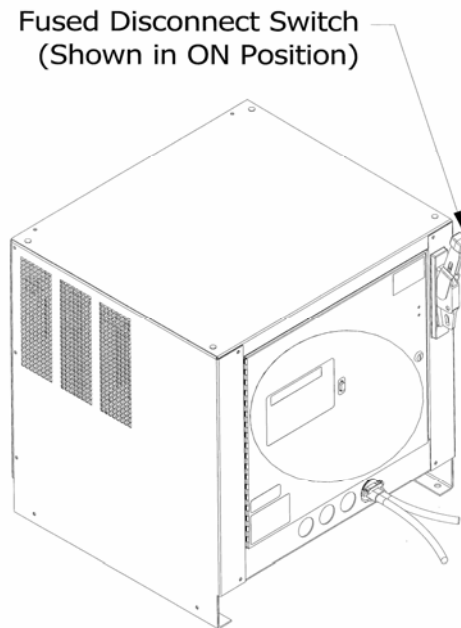

Figure 9-3 Fused Disconnect Switch

Remote Display Kit

ULTRA MAXX Remote Display Kit.....192356-1

A remote display kit is available for applications where the charger display is inaccessible or not visible. It allows remote control of Manual Stop and Equalize functions, as well as LED Status indicators.

This remote control box must be connected to charger as instructed on label provided with remote charge control. Operate the charger as instructed in Operation chapter of this manual and as instructed under any applicable option descriptions.

Wall Mounting Bracket

Wall Mounting Bracket.....390850-2

Facilitates wall mounting of T Case Chargers.

Lifting Eye Kit

Lifting Eye Kit.....191652

Facilitates lifting of T Case Chargers.

Archive Downloading Kit

Prestolite Data Link Kit.....193026

This kit is available to allow the user to download Ultra Maxx archive data using the front door mounted data port to a laptop PC via the PC's Serial Port. Data is stored in a "text" file format that can be imported into most popular spreadsheet programs.

Arcless Disconnect (Opt. 600)

To order chargers with "arcless disconnect", add "-005" to the base Spec No.

Example:
785T3-18UM w/Opt. 600 = Spec 500661-005

To order chargers with "arcless disconnect" and with "JIC" disconnect switch, add "-006" to the base Spec No.

Example:
785T3-18UM w/Opt. 500 & 600 = Spec 500661-006

This option is available for applications where it is desirable to suppress any contact arcing that may take place if the battery is disconnected from the charger while current is flowing. As always, "Manual Stop" should be used to stop the charger.

Remote Stop Pushbutton Kit

Remote Stop Pushbutton Kit.....196400-1

A Remote Stop Pushbutton Kit is available for applications where the charger control is not readily accessible or where an emergency stop pushbutton is desired. This mushroom-head pushbutton must be connected to the charger control per instructions provided in the kit. A 20 ft long modular cable is furnished with the kit for this purpose. The charger may be stopped at either location – the remote stop pushbutton or the charger control.

TROUBLESHOOTING

Troubleshooting Table

SYMPTOM	PROBABLE CAUSES	ACTION STEPS
No Display And No LED's	(1) No AC Voltage To Charger	1
	(2) Input Fuse(s) Blown	2
	(3) Control Trans. Breaker Tripped	3
	(4) Control Trans. Bad	4
	(5) Wrong Control Trans. Connection	5
	(6) Bad Harness/Connection – Loose or Incorrect	6
	(7) Bad Control Board	7
No Keypad Response	(1) Keypad Not Connected	10
	(2) Keypad Connected Improperly	10
	(3) Bad Control Board	7
	(4) Bad Keypad	11
Bad Lamp Test	(1) Keypad Not Connected	10
	(2) Keypad Connected Improperly	10
	(3) Bad Control Board	7
	(4) Bad Keypad	11
Display Illegible	(1) Noisy Environment	12
	(2) Low Input Voltage	13
	(3) Bad Control Board	7
Charger Doesn't Respond To Battery Being Connected	(1) Output Fuse Bad	14
	(2) Bad Harness/Connections – Loose Or Incorrect	6
	(3) Bad Control Board	7
	(4) Output Cables Reversed	15
	(5) Bad Output Connector	16
Control Not Responding (Locked Up)	(1) Noisy Environment	12
	(2) Bad Suppressor Core	17
	(3) Low Input Voltage	13
	(4) Power Interruption	12

SYMPTOM	PROBABLE CAUSES	ACTION STEPS
Unit Smells Hot	(1) Inadequate Ventilation (2) Ambient Too Hot (3) Lack of Maintenance (4) Bad Transformer (5) Bad Control Transformer (6) Bad Internal Power Connection (7) Bad Control Board (8) Bad Inductor (9) Wrong Amp/Hour Jumper (10) Bad Expansion Board (11) Fan not Operating (12) Bad Heat Sink Thermostat	18 19 20 21 4 23 7 24 25 26 8 9
Battery has Low S. G.'s	(1) Reading Not Temperature Corrected (2) Bad Battery (3) Bad Equalize Schedule (4) Charge Curve Incorrect (5) Rates Set Incorrectly (6) Fixed Temperature Set Incorrectly (7) Too Cold (8) Bad BID (9) Not Enough Charging Time	27 28 29 30 31 32 33 34 39
Battery Doesn't Last Full Shift	(1) Faulty > Lift Interrupt (2) Manual Disconnect (3) A.H. Required > Battery Nameplate (4) Battery Not Providing Nameplate Rating (5) Equalize Schedule (6) Charge Curve Incorrect (7) Rates Set Incorrectly (8) Fixed Temperature Set Incorrectly (9) Bad BID (10) Charger Too Small For Battery (11) Not Enough Charging Time	35 36 37 28 29 30 31 32 34 31 39
Battery Water Usage Is Too High	(1) Rates Set Incorrectly (2) Fixed Temperature Set Incorrectly (3) Charge Curve Incorrect (4) Equalize Schedule (5) Control On Forming Cycles (6) Control On Voltage/Time (7) Bad BID	31 32 30 29 38 40 34

SYMPTOM	PROBABLE CAUSES	ACTION STEPS
Low Number Of A.H.'s Returned To Battery	<ul style="list-style-type: none"> (1) Faulty Lift Interrupt (2) Battery Not Fully Discharged (3) Manual Disconnect (4) Rates Set Incorrectly (5) Fixed Temperature Set Incorrectly (6) Charge Curve Incorrect (7) Battery Not Providing Nameplate Rating (8) Bad Control Board (9) Bad BID 	<ul style="list-style-type: none"> 35 41 36 31 32 30 28 7 34
Battery Temperature Too High	<ul style="list-style-type: none"> (1) Insufficient Cool Down Before And/Or After Charging (2) Battery Power Demand Too Great (3) Rates Set Incorrectly (4) Fixed Temperature Set Incorrectly (5) Charge Curve Incorrect (6) Equalize Schedule (7) Control Set For Voltage/Time (8) Control Set For Cell Forming (9) Bad BID 	<ul style="list-style-type: none"> 42 43 31 32 30 29 40 38 34
Incorrect Charge Rate	<ul style="list-style-type: none"> (1) Rates Set Incorrectly (2) Fixed Temperature Set Incorrectly (3) Charge Curve Incorrect (4) Battery A.H. Not Equal To Charger A.H. (5) Battery Has Incorrect Size BID (6) Bad Control Board (7) BID not Programmed Properly 	<ul style="list-style-type: none"> 31 32 30 35 34 7 34
Long CDAC Approval Delay	<ul style="list-style-type: none"> (1) Bad CDAC Cabling (2) CDAC System Down (Computer) (3) No AC To Control Of 1 Or More Chargers (4) No CDAC System And Charger I.D. In Control isn't set to "0000" (5) Bad Expansion Board (6) Bad Control Board 	<ul style="list-style-type: none"> 44 45 46 47 26 7

SYMPTOM	PROBABLE CAUSES	ACTION STEPS
Doesn't Shutdown When Battery Is Disconnected	(1) Control Set For Forming Cycles (2) Bad Control Board (3) Bad/Incorrect Shunt	38 7 57
Noisy Unit	(1) Loose Sheet Metal (2) Bad Contactor (3) Loose Transformer Mounting (4) Loose Inductor Mounting (5) Noisy Inductor (6) Noisy Transformer (7) Placed On Rack That Makes Noise	48 49 50 51 52 53 54
Erratic Operation	(1) Bad Control Board (2) Bad SCR (3) Bad SCR Gate Connection (4) Control Wiring Loose From Heat Sink (5) Bad Harness/Connection – Loose Or Incorrect (6) Bad Power Connection (7) Bad Output Cable Connector (8) Bad Inductor (9) Moisture Inside Cabinet (10) Lack of Maintenance (11) High Ambient Temperature	7 55 22 22 6 23 16 24 56 20 19
Meter Reading Wrong (V/C)	(1) Bad Output Connect (2) Bad Harness/Connections – Loose Or Incorrect (3) Internal Power Connection (4) Bad Control Board	16 6 23 7
Meter Reading Wrong (Amps)	(1) Bad Output Connector (2) Bad Harness/Connections – Loose Or Incorrect (3) Internal Power Connection (4) Bad Control Board (5) Bad/Incorrect Shunt	16 7 23 7 57

SYMPTOM	PROBABLE CAUSES	ACTION STEPS
Display reads Unbalance Line Fault	(1) Incorrect Wiring To Primary Of Transformer	58
	(2) Incorrect Cabling To Transformer Secondary	59
	(3) Bad Harness/Connections – Loose Or Incorrect	6
	(4) Bad SCR	55
	(5) Bad Diode	60
	(6) Bad Control Board	7
	(7) Gate Lead Connections	22
	(8) AC Supply	1
	(9) Bad Transformer	21
High Input Current	(1) Incorrect Wiring To Primary Of Transformer	58
	(2) Incorrect Cabling To Transformer Secondary	59
	(3) Incorrect AC Input Jumper Setting	61
	(4) Bad Harness/Connections – Loose Or Incorrect	6
	(5) Bad SCR	55
	(6) Bad Diode	60
	(7) Bad Control Board	7
	(8) Gate Lead Connections	22
	(9) AC Supply	1
	(10) Bad Transformer	21
	(11) Bad Inductor	24

SYMPTOM	PROBABLE CAUSES	ACTION STEPS
Display Reads (Curve Error Fault)	(1) Bad Harness/Connections – Loose Or Incorrect (2) Bad SCR (3) Bad Diode (4) Bad Control Board (5) Incorrect Wiring To Primary Of Transformer (6) Bad Shunt	6 55 60 7 58 57
Display Reads (Backup Timer Fault)	(1) Fixed Temperature Set Incorrectly (2) Bad A.H. > Charger A.H. (3) Bad Output Cable Connector (4) Incorrect Charge Curve Setting (5) Bad Battery (6) Bad BID	32 35 16 30 28 34
Display Reads (Manual Stop Fault)	(1) Someone Pressed Manual Stop Button (2) Bad Connection (Keypad-Control) (3) Bad Keypad (4) Bad Control Board	36 10 11 7
Display Reads (Low Current Fault)	(1) Fixed Temperature Set Incorrectly (2) Bad Harness/Connections – Loose Or Incorrect (3) Battery Not Fully Formed (4) Bad Battery (5) Bad A.H. > Charger A.H. (6) Bad Internal Power Connection (7) AC Supply (8) Bad AC Fuse (9) Bad Contactor (10) Output Fuse Bad (11) Bad Control Board ((14) Bad Transformer (15) Bad Or Wrong Size Shunt (16) Output Connector Damaged or Auxiliary Leads Damaged (Opt 600) (17) Bad Heat Sink Thermostat, if equipped	32 6 63 28 64 23 1 2 49 14 7 21 57 70 9

SYMPTOM	PROBABLE CAUSES	ACTION STEPS
Display Reads (Low Battery Fault)	(1) Fixed Cell Setting Incorrect (2) Bad Harness/Connections – Loose Or Incorrect (3) Bad Battery (4) Bad Control Board (5) Bad Output Cables/Connector (6) BID not Programmed Properly	65 6 28 7 16 34
Display Reads (Hi Battery Fault)	(1) Fixed Cell Setting Incorrect (2) Bad Battery (3) Bad Control Board (4) BID not Programmed Properly	65 28 7 34
Display Reads (Setup Error Fault)	(1) Shunt Size Setting Has Been Changed On Control Board (2) Cell Size Setting Has Been Changed On Control Board (3) A.H. Resistor Has Been Changed On Control Board (4) Bad Keypad Connection (Keypad-Control) (5) Bad Keypad (6) Bad Control Board	66 67 68 10 11 7
Display Reads (Check AC Power)	(1) Intermittent AC Fail (Supply) (2) Control Transformer Connection (3) Bad Harness/Connection – Loose Or Incorrect (4) Bad Control Transformer (5) Bad Control Board	1 5 6 4 7

SYMPTOM	PROBABLE CAUSES	ACTION STEPS
Display Reads (Control Error COP)	(1) Noise (Supply) (2) Bad Control Board (3) Bad Suppressor Core	12 7 17
Display Reads (Control Error Clock Monitor)	(1) Noise (Supply) (2) Bad Control Board	12 7
Display Reads (Control Error Illegal Opcode)	(1) Noise (Supply) (2) Bad Control Board (3) Bad Suppressor Core	12 7 17
Display Reads (DIDT Fault)	(1) Bad Battery (2) Bad Control Board (3) Bad BID	28 7 34
Display Reads (High Amp Hour Fault)	(1) Bad Battery (2) Bad Control Board (3) Bad/Incorrect Shunt	28 7 57
Display Reads (Low Voltage Fault)	(1) Bad Battery (2) Bad Control Board (3) Bad Power Connection (4) Bad Harness/Connections - Loose or Incorrect	28 7 23 6
Display Reads (Bad BID Fault)	(1) Bad BID (2) Bad Power Connection (3) Bad Harness/Connections - Loose or Incorrect (4) Noisy Environment	34 23 6 12
Fan Does Not Work	(1) Connected Battery is at Finish Current or Terminated (2) Fan Fuse Blown (3) Bad Fan Switch/Capacitor (4) Control not Set Up Properly	62 69 71 72

Action Steps

1. Reference the INSTALLATION chapter (pg. 4-1).
2. Disconnect AC power and replace the bad AC fuse. Reapply AC power to the charger. If the fuse (s) blows instantly, check the connections on the input side of the contactor to make sure there are no shorts between any of the input wires. If that's okay, then check or change the control transformer. If the fuse(s) blow after the contactor closes, then check the input wiring from the contactor to the main transformer (s). Refer to the DIAGRAM chapter and locate the diagram for your charger to confirm that the charger is wired correctly. Also check the wires going up to the terminal block on the transformer; the wires will have numbers that correspond to the number on the terminal block. If they are incorrect, change them and start over. If it still blows fuse (s), the transformer will have to be replaced.
3. Reset the breaker. Disconnect the control and reapply AC power to the charger. Measure to see if 24VAC is on the output side of the control transformer. If there is, the control has failed. If there isn't 24VAC, then replace the control transformer. It is still possible that the control has failed; so once the control transformer is replaced, measure to see if the 24VAC drops once the control is connected.
4. Check and see if any input fuses are blown. Visually inspect the control transformer for discoloration on the casing of the input side of the control transformer. Disconnect the control before applying AC power. Once AC power is reapplied, measure the input voltage to the control transformer; it should be the AC supply voltage (208/240/480). If not, check the control transformer input wiring. If you did read the supply voltage, then measure the output side and you should read 24VAC. If not, replace the control transformer.
5. Look at the casing of the control transformer on the input side. Reference the DIAGRAM chapter to determine the input. There will be four pins and each one will be labeled as follows: COM (common), 208 (208VAC), 240 (240VAC), and 480 (480VAC). Some models may have a 575 (575VAC) pin. There should always be a wire on the common pin no matter what voltage is applied to the charger, and the second wire will go to the pin labeled as the voltage that is applied to operate the charger. Measure the voltage on the output side of the control transformer, it should read approximately 24VAC.
6. A bad harness/connection can cause many different problems. The best way to confirm a bad harness/connection problem is to take measurements where the harness is connected to the charger and then follow the wire (s) up the harness to the PC boards and measure there also. The measurement should match what was measured at the charger connection. If it doesn't, check the following: Check the connectors at the square plugs where the control harness connects to the charger harness; the connectors could be pressed out of the plugs. Make sure the connectors look okay inside the edge mount connector at the PC board (s). Make sure the harness connections are tight where they connect to the charger. Make sure the wires are crimped to the terminals tightly and also check to make sure that they are crimped to the bare wire and not to the insulation only.
7. To check the Control Board for proper operation, first check the DIP Switch settings of S1. Make sure the shunt size and cell selections match the charger, see the nameplate. For a 200A shunt, the 100A and 400A switches should be open. They should both be closed for a 600A shunt. Check the voltages between J10-1 (gnd) and the following points, they should be within 5% of the voltages given: J10-2 = 3.00V, J10-3 = 12.00V, and J10-4 = 5.00V. J10 is located at The bottom left of the PCB.

If the charger operates normally except there is no alphanumeric display, the check the connection from the display to the Control Board. Replace the Control Board if the connection is correct.

If the charger still does not work properly even though the above settings and voltages are correct, the Control Board may need replaced. However, this is unlikely and all other possibilities should be checked before taking this step.

8. Fan not operating (if equipped) - See "Fan does not work" symptom of this section.
9. Bad heat Sink thermostat (if equipped) - The thermostat is used on all fan equipped units. It is located on the center mounted heat sink. If the fan is okay and the unit still gets too hot, the thermostat will open and terminate the charge cycle with a low current shutdown. Check the thermostat when the unit is cool. It should have low resistance between its terminals. If the fan operates and the charger is operating within its normal limits and symptoms persist, replace the thermostat.

10. Look at the inside of the door and locate the Control Board . (Reference the illustrated Parts List for locations). The keypad is connected to the Control Board. Look up between the Control Board and the inside of the door. You should be able to see the keypad ribbon cable. The ribbon cable should be connected to a pin header on the Control Board. If it's not connected, or looks questionable, remove the Control Board and correct it.
11. With no battery connected to the charger, press all of the keys on the keypad and the display should indicate that the button did function. The only exception will be the Equalize and Stop keys. To test them, connect a battery and allow the charger to start, then press the button. The ULTRA MAXX was shipped set for automatic equalize which means unless this was changed, the Equalize button will not respond. To find out if the Status LED's on the keypad are okay, press key number "0" and a complete review will occur that starts out by performing a lamp test which lights all the Status LED's.
12. Temporarily shut down any equipment on the same voltage supply line and see if the charger starts to respond normally. If the charger does, then check all grounds going to the equipment that is shut down. If the problems still exist, then return power to all the other equipment and call your local PRESTOLITE POWER Representative.
13. Measure the AC supply voltage coming into the charger to confirm that it matches the charge input tap settings.
14. Use an Ohmmeter and measure directly across the DC Fuse. A good fuse will measure almost (0) Ohms and a bad one will measure a very high resistance, in the megohm range or greater. If for some reason a DC Fuse measures somewhere in between, replace the DC Fuse and send it in to your local PRESTOLITE POWER Representative.
15. Refer to the DIAGRAM chapter in the owners manual and locate the diagram for your charger to determine where the output cables connect to the charger. The black (Negative) output cable goes into the charger and connects to a bus bar on the end of the DC Fuse which is located on the left side of the unit. The red (Positive) output cable goes into the charger and connects to the leads of the inductor that is located on the right of the charger base. The output connector will have a (+) and (-) symbol on it. The (+) terminal should have the red output cable connected to it, and the (-) should have the black output cable connected to it.
16. Make sure the output connector does not have any cracks on its casing that could result in a short. Make sure the output cable lugs are making a good connection with the battery connector. You will see traces of pitting on the lug surface from arcing if there isn't a good connection. This could be the result of a weak retainer clip in the connector or lugs that were soldered on incorrectly. If the lugs had too much heat applied to them when the cables were soldered on, the solder will wick up the cable and make it very stiff. When they are inserted into the connector, the stiff cable forces the retainer clip down and creates poor connection between the battery connector and the charger connector.
17. Make sure the suppressor core is attached to the control wire harness with the green wire outside the core, and that it is not missing. Visually inspect the suppressor core for missing pieces or cracks. If so, replace the suppressor core.
18. Refer to the INSTALLATION chapter and go to the paragraph labeled "LOCATION". This will define the guide lines. If a charger has inadequate ventilation, many different problems can occur. If a charger runs under extreme temperatures, any component inside the charger could fail prematurely.
19. An extremely high ambient temperature can cause many different problems. If a charger runs under extreme temperatures, any component inside the charger could fail prematurely.
20. Refer to the MAINTENANCE chapter in the manual. Electrical parts tend to attract dust and dirt after a long period of time, which can cause parts to fail prematurely. If the unit is equipped with a fan, be sure it is in operating condition.
21. AC fuses are most likely to have failed. Visually inspect the transformer. If a winding has failed, the winding will appear to be burnt or look black. The varnish might be flaking off. Refer to the DIAGRAM chapter in the manual and locate the diagram for your charger. On the diagram there will be a winding configuration of the transformer. Disconnect the SCRs and diodes from the transformer and reapply AC to the charger. Measure the transformer secondary voltage, if less than 25VAC is present, replace the transformer.
22. Visually inspect for loose connections on the heat sink or components on the control board that appear to be bad. There are suppressors on the board that are designed to absorb energy surges. If the surge is too high the component will fail. It will be very dark in color or cracked.
23. Do a continuity or resistance test. Check for connection points that visually appear to have been exposed to extreme heat. Any connections that appear loose or overheated must be re-lugged and rechecked.

24. Connect a fully charged battery to the charger. Make sure that the charger is set to its maximum Fixed AH capacity (See the Programming Your UC2000 Control chapter in this manual). If the input current exceeds the nameplate rating (by more than 10%) for the input voltage range that the charger is connected to, replace the inductor. Also inspect the inductor for dark horizontal areas on the coil insulation. If any significant discoloration of the inductor is found, it should be replaced.
25. If the AH jumper is incorrect for the charger, it will cause the unit to charge at rates either higher or lower than nameplate rating.
26. To check the expansion board for proper operation, first make sure there is a good connection to the UC2000 Control board. The connection is in the lower center of the expansion PC board. Looking at the inside of the door, check the voltages at the following points: across C20 – 18 to 35 VDC, across C12 – 4.75 to 5.25 VDC, and across C19 – 4.75 to 5.25 VDC. Observe polarity when making these measurements. Check for the proper Charger I.D. number in function 43 (See the Programming Your UC2000 Control chapter of this manual) if the problem is long CDAC approval delays. Also check the CDAC cables for proper insertion or damage.

If the expansion board still does not work after these checks and/or if any of the voltage measurements are incorrect, replace the expansion PC board.

27. Specific Gravity readings vary with the temperature of the electrolyte. To temperature correct the Specific Gravity readings to match the nameplate ratings of the battery, use the following rule of thumb; + 1 S.G. point per 3° F that the electrolyte temperature exceeds 77° F.
28. Take Specific Gravity readings and measure Cell Voltages. If acid has been spilled or the battery has been extremely heated, it is possible that a battery's capacity could be greatly reduced, and the acid is not capable of increasing to the battery nameplate rating.
29. The proper equalize schedule is one that is tailored to the specific battery and charger operation. The UC2000 Auto Equalize feature can be used to automate the equalize schedule (See the UC2000 Features chapter of this manual).

Excess equalizing causes increased water usage. Too little or no equalizing can lead to battery sulfation and/or decrease battery shift run times. Adjusting the auto equalize number of cycles can improve the equalize performance (See the Programming Your UC2000 Control chapter of this manual). Some operations may also benefit from day of week or by BID cycle equalizing. This can be programmed by the Auto EQ type function to the UC2000 Control (See the Programming Your UC2000 Control chapter of this manual).
30. Using the Review feature of the control (See the Control Features chapter of this manual), check the charge curve setting of the charger. If it does not match the Battery Type (Standard, Sealed, Custom), reprogram the control to the proper curve. (Refer to the Programming Your UC2000 Control chapter of this manual).
31. Using the Review feature of the control (See the Control Features chapter of this manual), check the Fixed AH setting of the charger. If it does not match the battery nameplate rating of the battery (it should be within 20% of the battery nameplate rating), reprogram the control to the proper Fixed AH rating (Refer to the Programming Your UC2000 Control chapter of this manual). If this is not possible due to the maximum rating of the charger, a larger charger should be used.
32. Refer to Program chapter. Go to function number 37 and confirm that the control is set for the correct Fixed Temperature Setting. If not, enter the correct setting.
33. If battery electrolyte temperatures are well below 32° F, the ULTRA MAXX will not be able to adequately charge the battery. Battery insulation or heaters would be required to keep the battery electrolyte temperatures close to 32°F.
34. The BID module communicates battery temperature, cell size, voltage, ampere hour size, BID no. , and type to the charger. A nonfunctioning or incorrectly programmed BID can cause charging and /or battery problems. Using the UC2000 Review Features (See the UC2000 Review Features in this manual), check the review items listed above. Replace a nonfunctioning or incorrectly programmed module with a new one.
35. A faulty lift interrupt on a lift truck can cause the battery to be over or under discharged. Check the interrupt voltage of the interrupt following the procedures found in your truck and/or lift interrupt operator's manual (s).
36. When it is necessary to stop the charge cycle before charge complete, *always terminate the charge cycle by pressing the STOP key before disconnecting the battery from the charger.*

37. If the application requires a larger AH battery than is presently in use, the only long term solution is to replace the battery with one of the proper AH rating.
38. If the control is set to perform forming cycles , DV/DT termination is disabled, and the low current shutdown is disabled. To return to normal operation, program the control to "00" Forming Cycles (See the Programming Your UC2000 Control chapter of this manual).
39. Not enough charging time - In cases where opportunity charging is taking place, more time charging may be needed to keep the battery within its proper operating range. Be sure that the battery is charged per the users operations guidelines. Those procedures may need to be adjusted to allow for more charging time or less battery load.
40. Program the control to DV/DT charge termination (See the Programming Your UC2000 Control chapter of this manual).
41. If fully discharged batteries are desired for efficient operations, lift interrupts can be installed on the trucks to allow the operators to recognize a fully discharged battery.
42. In opportunity charging applications, higher than normal battery temperatures should be expected. In cases where the temperature is exceeding a reasonable value, utilize the battery cooling feature of the UC2000 Control or adjust the battery use versus charging schedule to allow for lighter loads on the battery. In a standard charging mode, a cool down can be programmed into the UC2000 Control to add a specified cool down time between charge termination and the signaling of charge complete (See the Programming Your UC2000 Control chapter of this manual). A delayed start can be programmed into the UC2000 Control to add a specified delay time between battery connection and the start on the charge (See the Programming Your UC2000 Control chapter of this manual).
43. Battery is being discharged at too high (fast) of a rate. Consult the battery manufacturer or distributor for applications assistance.
44. Check and repair/reconnect connections between the last charger that is polling properly and the next charger connected (See your CDAC Owners Manual).
45. Reboot computer and select "Restart CDAC after abnormal termination" menu item (See your CDAC Owners Manual).
46. Check for control operation on all CDAC connected chargers down stream of the last connected charger that is polling properly (or all CDAC connected chargers). Loss of AC power connections or proper control transformer voltage will prevent proper CDAC operation (See CDAC Owners Manual).
47. The Charger I.D. function in the UC2000 Control must be set to 0000 for proper normal (non-CDAC) operation (See the Programming Your UC2000 Control chapter of this manual).
48. Check and tighten all sheet metal fasteners (screws and bolts).
49. Check the voltage across the contactor coil. If the voltage is 24VAC +/- 10%, replace contactor with a properly functioning part.
50. Check and tighten all transformer mounting screws.
51. Check and tighten all inductor mounting screws.
52. Check inductor for visible damage. Coat the transformer coil with a Prestolite approved (contact Prestolite Service) air dry varnish. If that fails to reduce the noise level, drive a shim of the proper material (contact Prestolite Service) between coil and core.
53. Check transformer for visible damage. Coat the transformer coil with a Prestolite approved (contact Prestolite Service) air dry varnish. If that fails to reduce the noise level, drive a shim of the proper material (contact Prestolite Service) between coil and core.
54. Check for and tighten any loose fasteners on the rack. Remove any lightweight loose objects that are on the rack near the charger.

55. Check the SCR as described below. If it tests faulty, replace with an SCR of the proper type.
Connect a VOM set on the 1k Ohms scale; positive to SCR anode (stud), negative to SCR cathode (heavy red lead). The VOM should read a very high impedance (near open circuit). Touch and hold the SCR gate lead (small white lead) to the SCR anode. The VOM should read a low impedance (near short circuit). If the SCR reads shorted before the gate is touched to the anode, the SCR is bad. If the SCR reads open when the gate is touched to the anode, the SCR is bad (A DVM may be used if it is set to the Diode scale). A high impedance will be indicated by an over range indication (usually OL), a low impedance will be indicated by a low reading 1.00.
56. Disconnect the charger from the battery and the input AC. Blow out the charger with compressed air, and allow the unit to set unused for 1 to 2 weeks in a warm dry environment (as hot, up to 104° F) and dry as possible.
57. Replace damaged and/or incorrect shunt with one of correct size.
58. Reconnect transformer primary wiring to match the schematic included in this manual.
59. Reconnect transformer secondary wiring to match the schematic included in this manual.
60. Using a VOM or DVM, check the diode for proper operation as stated below.
Set the VOM to the 1k Ohms scale. Connect the positive VOM lead to the anode (cable lead) and the negative VOM lead to the cathode (stud). The VOM should read a low impedance (near short circuit). Reverse the VOM leads. The VOM should read high impedance (near open circuit). Replace any diodes that fail with the proper part.
61. Reconnect the input primary jumpers to match the input voltage, see the installation chapter of this manual. *Be sure to connect the control transformer primary properly.*
62. Connect a fully discharged battery. With the charger at full output current, the fan should operate.
63. Program the forming cycles feature of the UC2000 Control to the number of cycles required to properly form the battery. See the Programming Your UC2000 chapter of this manual.
64. Reprogram the fixed AH setting of the UC2000 Control to match the battery nameplate AH rating. See the Programming Your UC2000 chapter of this manual.
65. Program the UC2000 Control to Multi-cell mode "ON" or program the Fixed cell setting to the proper cell size for your battery. See the Programming Your UC2000 chapter of this manual.
66. Set the control PCB shunt size dip switch to match the shunt on the charger (1 leaf = 100A, 2 leaves = 200A, 4 leaves = 400A, 4 leaves 1-3/4" wide = 600A). Reset by pressing both Arrow keys simultaneously until the display resets.
67. Set the Control PCB cell size dip switches to match the charger nameplate cell size. Reset by pressing both Arrow keys simultaneously until the display resets.
68. Replace the ampere hour jumper with one that matches the nameplate AH rating of the charger. See the parts list included in this manual. Reset by pressing both Arrow keys simultaneously until the display resets.
69. Check the 2 fuses that are in series with the fan motor. If one or both are found to be blown, replace them with one (s) that are of the same type and size. Also see the wiring diagram to check for proper connection.
70. Carefully examine the charger and battery connector auxiliary contacts. Look for open wiring, or loose connectors. Also check the output cabling; be sure that the small signal wiring is not cut or otherwise damaged in some way.
71. If the wiring and fan fuses all are okay, check the solid state fan switch in series with 1 lead of the fan motor and fuses. With a discharged battery connected to the charging unit, read the AC voltage on input and output sides of the switch. It must appear at both terminals, approximately 230VAC. If that is okay, disconnect all power to the charger and check the fan motor starter capacitor with an ohm meter.
72. Perform a master reset on the control assembly. Apply AC power to the charger while holding the 2 arrow keys Pressed until the control displays "Master Reset".

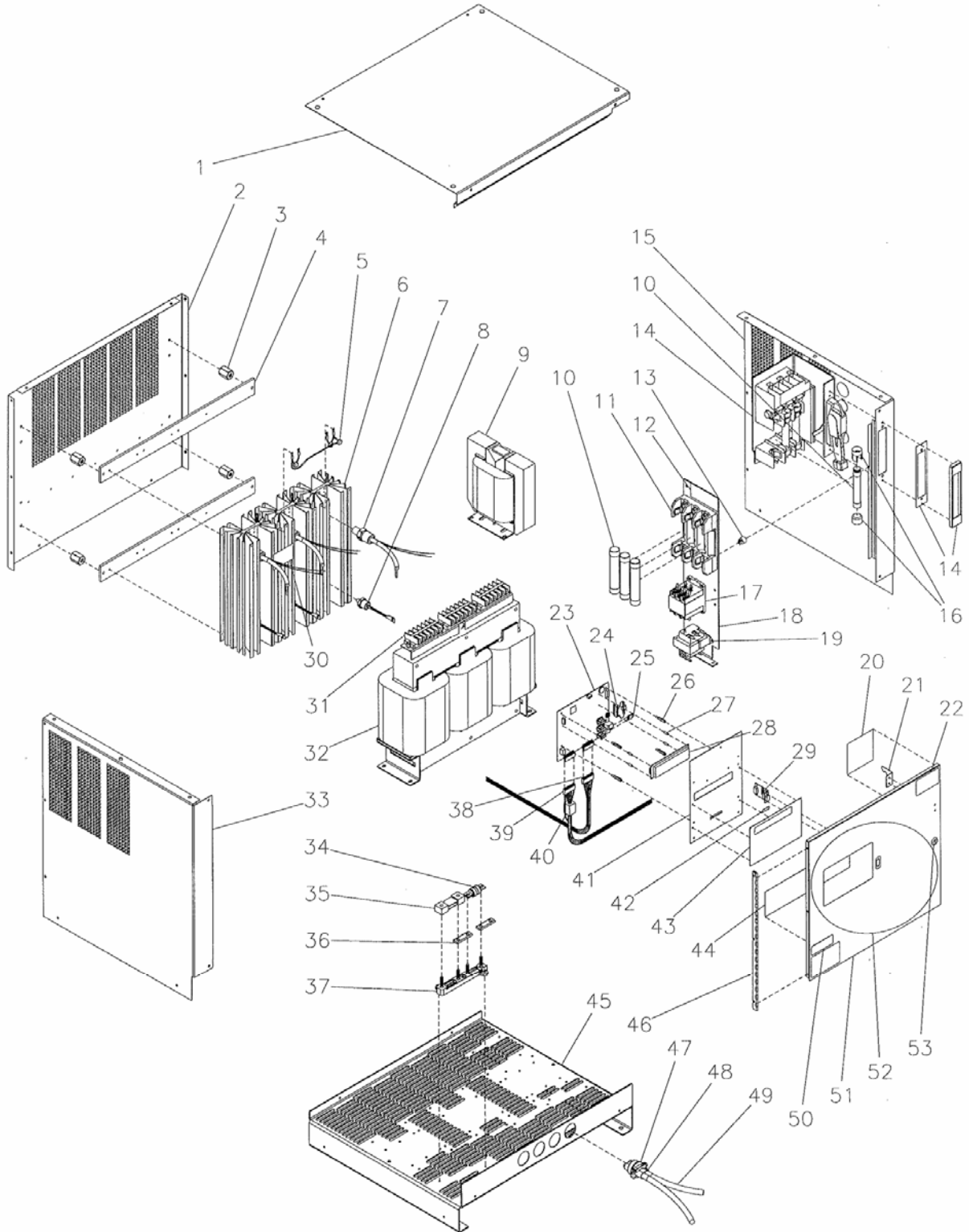

Figure 11-1

Parts List For Figure 11-1

		500659C-1 500659C-2 500659C-3	500660C-1 500660C-2 500660C-3	500661C-1 500661C-2 500661C-3	500662C-1 500662C-2 500662C-3	500723C-1	500663C-1 500663C-2 500663C-3	500664C-1 500664C-2 500664C-3	500665C-3 500665C-4 500665C-5 500665C-7 555T3-40UM
		680T3-12UM	680T3-18UM	785T3-18UM	910T3-18UM	425T3-24UM	680T3-24UM	785T3-24UM	
Item No.	Item Description	Part No.	Part No.	Part No.	Part No.	Part No.	Part No.	Part No.	Part No.
1	Panel, Top (-1 thru -6 Spec only) Panel, Top (-7 Spec only)	194376 N/A	194376 N/A	194376 N/A	194376 N/A	194376 N/A	194376 N/A	194376 N/A	194376 See Note 1
2	Panel, Rear (-1 thru -6 Spec only) Panel, Rear (-7 Spec only)	194373 N/A	194373 N/A	194373 N/A	194373 N/A	194373 N/A	194373 N/A	194373 N/A	194373 196546
3	Insulator, Heat Sink	404033	404033	404033	404033	404033	404033	404033	404033
4	Insulator, Heat Sink	196222	196222	196222	196222	196222	196222	196222	196222
5	Capacitor, Ay.	194708	194708	194708	194708	194708	194708	194708	194708
6	Heat Sink, Extruded	194391	194391	194391	194391	194391	194391	194391	194391
7	Rectifier, Silicon Controlled	192113-1	192113-1	192113-1	192113-1	192113-1	192113-1	192113-1	192113-1
8	Diode, Silicon, 150 A.	402832-3	402832-3	402832-3	402832-3	402832-3	402832-3	402832-3	402832-3
9	Choke	192178	192179	192179	196115	192180	196109	196117	196111
10	Fuse, AC Input (208 V.) (-1 & -2 Spec only) Fuse, AC Input (240 V.) (-1,-2,-3,-5 & -6 Spec only) Fuse, AC Input (480 V.) (-1 thru -7 Spec) Fuse, AC Input (575 V.) (-3,-4,-5,-6 & -7 Spec only) * Requires Item #16, 1 pair per fuse.	196030-30 196030-25 196030-12 N/A	196030-45 196030-40 196030-20 * 196030-15 *	196030-60 196030-50 196030-25 * 196030-20 *	196030-60 196030-50 196030-25 * 196030-20 *	196030-35 196030-30* 196030-15* N/A	196030-60 196030-60 196030-30 * 196030-25 *	196030-60 196030-60 196030-30 * 196030-25 *	N/A N/A 196030-40 196030-35
11	Block, Fuse (-1, -3, -5 & -7 Spec only) Block, Fuse (-2, -4 & -6 Spec only)	404605-4 N/A	404605-5 N/A	404605-5 N/A	404605-5 N/A	404605-5 N/A	404605-5 N/A	404605-5 N/A	404605-5 N/A
12	Label, Input	196182	196182	196182	196182	196182	196182	196182	196182
13	Grommet, Mounting	194827-1	194827-1	194827-1	194827-1	194827-1	194827-1	194827-1	194827-1
14	Switch, Disconnect (-1, -3, -5 & -7 Spec only) Switch, Disconnect (-2, -4 & -6 Spec only)	N/A 403956-1	N/A 403956-2	N/A 403956-2	N/A 403956-2	N/A 403956-2	N/A 403956-2	N/A 403956-2	N/A 403956-2
15	Panel, Side, Right (-1, -3 & -5 Spec only) Panel, Side, Right (-2, -4 & -6 Spec only) Panel, Side, Right (-7 Spec only)	194521 194375 N/A	194521 194375 N/A	194521 194375 N/A	194521 194375 N/A	194521 194375 N/A	194521 194375 N/A	194521 194375 N/A	194521 194375 196562
16	Reducer, Fuse	N/A	196017	196017	196017	196017	196017	196017	N/A
17	Contact, 3 Pole (-1 & -2 Spec only) Contact, 3 Pole (-3,-4,-5,-6 & -7 Spec only)	406243-1 406243-1	406243-1 406243-1	406244-1 406243-1	406244-1 406243-1	406243-1 N/A	406244-1 406244-1	406244-1 406244-1	N/A 406243-1
18	Panel, Interior	194447	194447	194447	194447	194447	194447	194447	194447
19	Transformer, Control (-1 & -2 Spec only) Transformer, Control (-3,-4,-5,-6 & -7 Spec only)	406247-2 406247-4	406247-2 406247-4	406247-2 406247-4	406247-2 406247-4	406247-2 N/A	406247-2 406247-4	406247-2 406247-4	N/A 406247-4
20	Label, AC Input (208/240/480 Volt) Label, AC Input (240/480/575 Volt) Label, AC Input (480/575 Volt)	406461 194140 N/A	406461 194140 N/A	406461 194140 N/A	406461 194140 N/A	406461 194140 N/A	406461 194140 N/A	406461 194140 N/A	N/A N/A 192667
21	Latch, Disconnect (-1, -3, -5 & -7 Spec only) Latch, Disconnect (-2, -4 & -6 Spec only)	N/A 407250	N/A 407250	N/A 407250	N/A 407250	N/A 407250	N/A 407250	N/A 407250	N/A 407250
22	Label, Disc. Sw. (-1, -3, -5 & -7 Spec only) Label, Disc. Sw. (-2, -4 & -6 Spec only)	N/A 407250	N/A 407250	N/A 407250	N/A 407250	N/A 407250	N/A 407250	N/A 407250	N/A 407250
23	Board, PC, Control	196425-1	196425-1	196425-1	196425-1	196425-1	196425-1	196425-1	196425-2
24	Connector, Arcless Disconnect	196639	196639	196639	196639	196639	196639	196639	196639
25	Connector, Amp-Hour	192302-1	192302-1	192302-2	192302-8	192302-5	192302-1	192302-2	192302-4
26	Spacer, Hex, Threaded, Alum, 1"	192262-2	192262-2	192262-2	192262-2	192262-2	192262-2	192262-2	192262-2
27	Support, PC Board, Display	196603	196603	196603	196603	196603	196603	196603	196603
28	Display, Vacuum Fluorescent	196611	196611	196611	196611	196611	196611	196611	196611
29	Board, PC, Ultra Communications	196626	196626	196626	196626	196626	196626	196626	196626
30	Label, Warning	406518	406518	406518	406518	406518	406518	406518	406518
31	Block, Terminal	192273	192273	192273	192273	192273	192273	192273	192273

193111-067
ULTRA MAXX W/O FAN PARTS LIST

Parts List For Figure 11-1 (Continued)

Item No.	Item Description	Part No.	Part No.	Part No.	Part No.	Part No.	Part No.	Part No.	Part No.
		500659C-1 500659C-2 500659C-3	500660C-1 500660C-2 500660C-3	500661C-1 500661C-2 500661C-3	500662C-1 500662C-2 500662C-3	500723C-1	500663C-1 500663C-2 500663C-3	500664C-1 500664C-2 500664C-3	500665C-3 500665C-4 500665C-5
		680T3-12UM	680T3-18UM	785T3-18UM	910T3-18UM	425T3-24UM	680T3-24UM	785T3-24UM	500665C-7 555T3-40UM
		500660C-5 500660C-6	500661C-5 500661C-6				500663C-5		
32	Transformer Assy. (-1 & -2 Spec only) Transformer Assy. (-3,-4,-5,-6 & -7 Spec only)	196228 196264	196232 196268	196234 196270	196236 196786	196238 N/A	196242 196278	196631 196280	N/A 196248
33	Panel, Side, Left (-1 thru -6 Spec only) Panel, Side, Left (-7 Spec only)	194374 N/A	194374 N/A	194374 N/A	194374 N/A	194374 N/A	194374 N/A	194374 N/A	194374 196561
34	Fuse, DC	Y1890-6	Y1890-6	Y1890-7	Y1890-8	Y1890-4	Y1890-6	Y1890-7	Y1890-5
35	Shunt, Current	193125-3	193125-3	193125-3	193125-3	193125-2	193125-3	193125-3	193125-2
36	Bus Bar	392458	392458	392458	392458	392458	392458	392458	392458
37	Insulator, Shunt	193114	193114	193114	193114	193114	193114	193114	193114
38	Harness, Wire, Rectifier	194808	194808	194808	194808	194808	194808	194808	194808
39	Harness, Wire, Interior Panel	194810	194810	194810	194810	194810	194810	194810	194810
40	Suppressor, Harness	192266-1	192266-1	192266-1	192266-1	192266-1	192266-1	192266-1	192266-1
41	Panel, Control	196582	196582	196582	196582	196582	196582	196582	196582
42	Label, Not For Telephone Use	196533	196533	196533	196533	196533	196533	196533	196533
43	Kit, Switch, Assy.	192306	192306	192306	192306	192306	192306	192306	192306
44	Label, Warning & Information	196183	196183	196183	196183	196183	196183	196183	196183
45	Base, Mounting	194372	194372	194372	194372	194372	194372	194372	194372
46	Hinge, Door	194377	194377	194377	194377	194377	194377	194377	194377
47	Connector, Strain Relief	W10080-5	W10080-5	W10080-5	W10080-5	W10080-5	W10080-5	W10080-5	W10080-5
48	Cover, Neoprene	378234-13	378234-13	378234-13	378234-13	378234-13	378234-13	378234-13	378234-13
49	Cable, Output (-1,-2,-3,-4 & -7 Spec only) Cable, Output (-5 & -6 Spec only)	396263-81 N/A	396263-81 195488-1	396263-82 195488-3	396263-82 N/A	396263-80 N/A	396263-81 195488-1	396263-82 N/A	396263-81 195488-1
50	Label, UL & CUL	404079	404079	404079	404079	404079	404079	404079	404079
51	Door, Hinged	196635	196635	196635	196635	196635	196635	196635	196635
52	Overlay, Door, Ultra Maxx	196634	196634	196634	196634	196634	196634	196634	196634
53	Latch, Door	194530	194530	194530	194530	194530	194530	194530	194530

Note 1: For chargers with weather-resistant enclosures (-7 Spec),
in place of a Top Panel (Item 1) the following parts are used:

Canopy	195040	(Ref. Fig. 11-2, Item 2)
Support, Rear, Canopy	195064	(Ref. Fig. 11-2, Item 7)
Support, Side, Canopy	195065	(Ref. Fig. 11-2, Item 8)
Support, Front, Canopy	195063	(Ref. Fig. 11-2, Item 9)

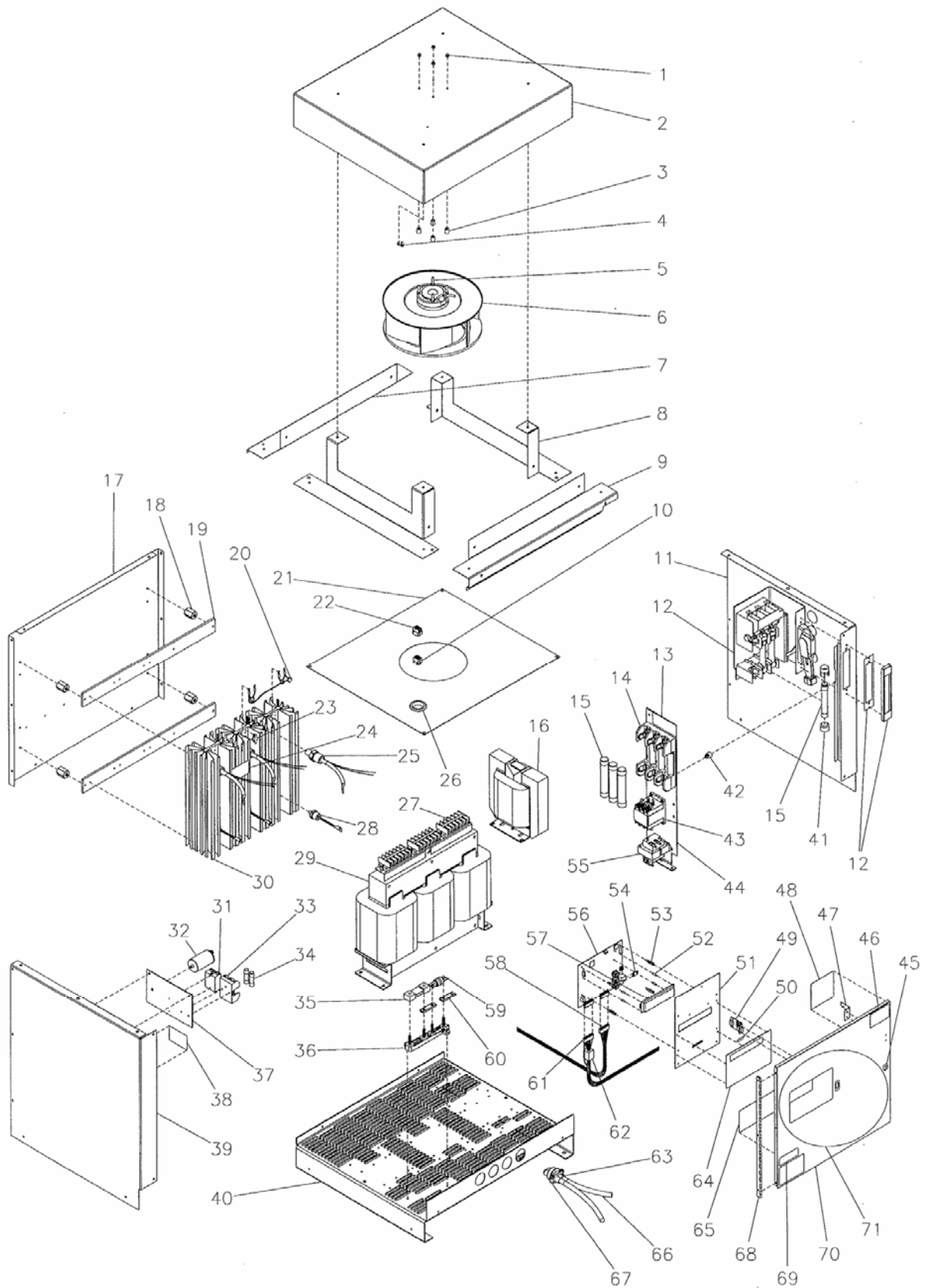

Figure 11-2

Parts List For Figure 11-2

		500666C-3 500666C-4 500666C-5 500666C-6 1045T3-18UMF	500667C-3 500667C-4 500667C-5 1270T3-18UMF	500702C-3 500702C-4 500702C-5 910T3-24UMF	500668C-3 500668C-4 1045T3-24UMF	500669C-3 500669C-4 1270T3-24UMF	500696C-3 785T3-40UMF
Item No.	Item Description	Part No.	Part No.	Part No.	Part No.	Part No.	Part No.
1	Nut, Keps, M6	50MS732-8	50MS732-8	50MS732-8	50MS732-8	50MS732-8	50MS732-8
2	Canopy	195040	195040	195040	195040	195040	195040
3	Spacer, Impeller	196352	196352	196352	196352	196352	196352
4	Clamp, Wire	196390-1	196390-1	196390-1	196390-1	196390-1	196390-1
5	Stud, Threaded, M6 x 40mm	196064-2	196064-2	196064-2	196064-2	196064-2	196064-2
6	Impeller	196078	196078	196078	196078	196078	196078
7	Support, Rear, Canopy	195064	195064	195064	195064	195064	195064
8	Support, Side, Canopy	195065	195065	195065	195065	195065	195065
9	Support, Front, Canopy	195063	195063	195063	195063	195063	195063
10	Harness, Wire	196636	196636	196636	196636	196636	196636
11	Panel, Side, Right (-3 & -5 Spec only) Panel, Side, Right (-4 & -6 Spec only)	196562 196564	196562 196564	196562 196564	196562 196564	196562 196564	196562 196564
12	Switch, Disconnect (-3 & -5 Spec only) Switch, Disconnect (-4 & -6 Spec only)	N/A 403956-2	N/A 403956-2	N/A 403956-2	N/A 403956-2	N/A 403956-2	N/A 403956-2
13	Label, Input	196182	196182	196182	196182	196182	196182
14	Block, Fuse (-3 & -5 Spec only) Block, Fuse (-4 & -6 Spec only)	404605-5 N/A	404605-5 N/A	404605-5 N/A	404605-5 N/A	404605-5 N/A	404605-5 N/A
15	Fuse, AC Input (240 V.) Fuse, AC Input (480 V.) Fuse, AC Input (575 V.) * Requires Item #41, 1 pair per fuse.	196030-60 196030-30 * 196030-25 *	N/A 196030-40 196030-35	N/A 196030-40 196030-30 *	N/A 196030-45 196030-35	N/A 196030-50 196030-40	N/A 196030-60 196030-45
16	Choke	192179	192179	196109	196109	196117	196111
17	Panel, Rear	196546	196546	196546	196546	196546	196546
18	Insulator, Heat Sink	404033	404033	404033	404033	404033	404033
19	Insulator, Heat Sink	196222	196222	196222	196222	196222	196222
20	Capacitor, Ay.	194708	194708	194708	194708	194708	194708
21	Panel, Top	196563	196563	196563	196563	196563	196563
22	Housing, Pin	401563-2	401563-2	401563-2	401563-2	401563-2	401563-2
23	Thermostat	196060	196060	196060	196060	196060	196060
24	Label, Warning	406518	406518	406518	406518	406518	406518
25	Rectifier, Silicon Controlled	192113-1	192113-1	192113-1	192113-1	192113-1	192113-1
26	Grommet, Rubber	402037-27	402037-27	402037-27	402037-27	402037-27	402037-27
27	Block, Terminal	192273	192273	192273	192273	192273	192273
28	Diode, Silicon, 150 A.	402832-3	402832-3	402832-3	402832-3	402832-3	402832-3
29	Transformer Assy.	196268	196592	196595	196595	196598	196601
30	Heat Sink, Extruded	194391	194391	194391	194391	194391	194391
31	Relay, Solid State	196570-1	196570-1	196570-1	196570-1	196570-1	196570-1
32	Capacitor, Impeller	196055	196055	196055	196055	196055	196055
33	Block, Fuse	405357-1	405357-1	405357-1	405357-1	405357-1	405357-1
34	Fuse, 3 A., 250 V.	W10085-2	W10085-2	W10085-2	W10085-2	W10085-2	W10085-2
35	Shunt, Current	193125-3	193125-4	193125-3	193125-3	193125-4	193125-3
36	Insulator, Shunt	193114	193114	193114	193114	193114	193114
37	Panel, Mounting, Relay	196569	196569	196569	196569	196569	196569
38	Label, Fan Fuse	196095	196095	196095	196095	196095	196095
39	Panel, Side, Left	196561	196561	196561	196561	196561	196561

Parts List For Figure 11-2 (Continued)

		500666C-3 500666C-4 500666C-5 500666C-6 1045T3-18UMF	500667C-3 500667C-4 500667C-5 1270T3-18UMF	500702C-3 500702C-4 500702C-5 910T3-24UMF	500668C-3 500668C-4 1045T3-24UMF	500669C-3 500669C-4 1270T3-24UMF	500696C-3 785T3-40UMF
Item No.	Item Description	Part No.	Part No.	Part No.	Part No.	Part No.	Part No.
40	Base, Mounting	194372	194372	194372	194372	194372	194372
41	Reducer, Fuse	196017	N/A	196017	N/A	N/A	N/A
42	Grommet, Mounting	194827-1	194827-1	194827-1	194827-1	194827-1	194827-1
43	Contactor, 3 Pole	406244-1	406243-1	406243-1	406243-1	406243-1	406244-1
44	Panel, Interior	194447	194447	194447	194447	194447	194447
45	Latch, Door	194530	194530	194530	194530	194530	194530
46	Label, Disc. Sw. (-3 & -5 Spec only) Label, Disc. Sw. (-4 & -6 Spec only)	N/A 407250	N/A 407250	N/A 407250	N/A 407250	N/A 407250	N/A 407250
47	Latch, Disconnect (-3 & -5 Spec only) Latch, Disconnect (-4 & -6 Spec only)	N/A 407250	N/A 407250	N/A 407250	N/A 407250	N/A 407250	N/A 407250
48	Label, AC Input (240/480/575 Volt) Label, AC Input (480/575 Volt)	194140 192667	194140 192667	194140 192667	194140 192667	194140 192667	194140 192667
49	Board, PC, Ultra Communications	196626	196626	196626	196626	196626	196626
50	Label, Not For Telephone Use	196533	196533	196533	196533	196533	196533
51	Panel, Control	196582	196582	196582	196582	196582	196582
52	Support, PC Board, Display	196603	196603	196603	196603	196603	196603
53	Spacer, Hex, Threaded, Alum, 1"	192262-2	192262-2	192262-2	192262-2	192262-2	192262-2
54	Connector, Amp-Hour	192302-9	192302-5	192302-8	192302-9	192302-5	192302-2
55	Transformer, Control (240/480/575 V.)	406247-4	406247-4	406247-4	406247-4	406247-4	406247-4
56	Board, PC, Control	196425-1	196425-1	196425-1	196425-1	196425-1	196425-2
57	Display, Vacuum Fluorescent	196611	196611	196611	196611	196611	196611
58	Harness, Wire, Rectifier	194808	194808	194808	194808	194808	194808
59	Fuse, DC	Y1890-8	Y1890-9	Y1890-8	Y1890-8	Y1890-9	Y1890-7
60	Bus Bar	392458	392458	392458	392458	392458	392458
61	Harness, Wire, Interior Panel	194810	194810	194810	194810	194810	194810
62	Suppressor, Harness	192266-1	192266-1	192266-1	192266-1	192266-1	192266-1
63	Cover, Neoprene	378234-13	378234-13	378234-13	378234-13	378234-13	378234-13
64	Kit, Switch, Assy.	192306	192306	192306	192306	192306	192306
65	Label, Warning & Information	196183	196183	196183	196183	196183	196183
66	Cable, Output (-3 & -4 Spec only) Cable, Output (-5 & -6 Spec only)	396263-95 195488-13	396263-93 195488-21	396263-82 195488-3	396263-95 N/A	396263-93 N/A	396263-82 N/A
67	Connector, Strain Relief	W10080-5	W10080-5	W10080-5	W10080-5	W10080-5	W10080-5
68	Hinge, Door	194377	194377	194377	194377	194377	194377
69	Label, UL & CUL	404079	404079	404079	404079	404079	404079
70	Door, Hinged	196635	196635	196635	196635	196635	196635
71	Overlay, Door, Ultra Maxx	196634	196634	196634	196634	196634	196634

Parts List For Figure 11-2 (Continued)

Item No.	Item Description	Part No.	Part No.	Part No.	Part No.	Part No.	Part No.
		500876C-3					
		910T3-40UMF					
1	Nut, Keps, M6	50MS732-8					
2	Canopy	195040					
3	Spacer, Impeller	196352					
4	Clamp, Wire	196390-1					
5	Stud, Threaded, M6 x 40mm	196064-2					
6	Impeller	196078					
7	Support, Rear, Canopy	195064					
8	Support, Side, Canopy	195065					
9	Support, Front, Canopy	195063					
10	Harness, Wire	196636					
11	Panel, Side, Right (-3 & -5 Spec only)	196562					
	Panel, Side, Right (-4 & -6 Spec only)	196564					
12	Switch, Disconnect (-3 & -5 Spec only)	N/A					
	Switch, Disconnect (-4 & -6 Spec only)	403956-2					
13	Label, Input	196182					
14	Block, Fuse (-3 & -5 Spec only)	404605-5					
	Block, Fuse (-4 & -6 Spec only)	N/A					
15	Fuse, AC Input (240 V.)	N/A					
	Fuse, AC Input (480 V.)	196030-60					
	Fuse, AC Input (575 V.)	196030-45					
	* Requires Item #41, 1 pair per fuse.						
16	Choke	197268					
17	Panel, Rear	196546					
18	Insulator, Heat Sink	404033					
19	Insulator, Heat Sink	196222					
20	Capacitor, Ay.	194708					
21	Panel, Top	196563					
22	Housing, Pin	401563-2					
23	Thermostat	196060					
24	Label, Warning	406518					
25	Rectifier, Silicon Controlled	192113-1					
26	Grommet, Rubber	402037-27					
27	Block, Terminal	192273					
28	Diode, Silicon, 150 A.	402832-3					
29	Transformer Assy.	196601					
30	Heat Sink, Extruded	194391					
31	Relay, Solid State	196570-1					
32	Capacitor, Impeller	196055					
33	Block, Fuse	405357-1					
34	Fuse, 3 A., 250 V.	W10085-2					
35	Shunt, Current	193125-3					
36	Insulator, Shunt	193114					
37	Panel, Mounting, Relay	196569					
38	Label, Fan Fuse	196095					
39	Panel, Side, Left	196561					

Parts List For Figure 11-2 (Continued)

Item No.	Item Description	Part No.	Part No.	Part No.	Part No.	Part No.	Part No.
		500876C-3					
		910T3-40UMF					
40	Base, Mounting	194372					
41	Reducer, Fuse	N/A					
42	Grommet, Mounting	194827-1					
43	Contactor, 3 Pole	406244-1					
44	Panel, Interior	194447					
45	Latch, Door	194530					
46	Label, Disc. Sw. (-3 & -5 Spec only) Label, Disc. Sw. (-4 & -6 Spec only)	N/A 407250					
47	Latch, Disconnect (-3 & -5 Spec only) Latch, Disconnect (-4 & -6 Spec only)	N/A 407250					
48	Label, AC Input (240/480/575 Volt) Label, AC Input (480/575 Volt)	194140 192667					
49	Board, PC, Ultra Communications	196626					
50	Label, Not For Telephone Use	196533					
51	Panel, Control	196582					
52	Support, PC Board, Display	196603					
53	Spacer, Hex, Threaded, Alum, 1"	192262-2					
54	Connector, Amp-Hour	192302-8					
55	Transformer, Control (240/480/575 V.)	406247-4					
56	Board, PC, Control	196425-2					
57	Display, Vacuum Fluorescent	196611					
58	Harness, Wire, Rectifier	194808					
59	Fuse, DC	Y1890-8					
60	Bus Bar	392458					
61	Harness, Wire, Interior Panel	194810					
62	Suppressor, Harness	192266-1					
63	Cover, Neoprene	378234-13					
64	Kit, Switch, Assy.	192306					
65	Label, Warning & Information	196183					
66	Cable, Output (-3 & -4 Spec only) Cable, Output (-5 & -6 Spec only)	396263-82 N/A					
67	Connector, Strain Relief	W10080-5					
68	Hinge, Door	194377					
69	Label, UL & CUL	404079					
70	Door, Hinged	196635					
71	Overlay, Door, Ultra Maxx	196634					

DIAGRAMS

INPUT VOLTAGE	DIAGRAMS		DIMENSIONAL OUTLINE
	WITHOUT FAN	WITH FAN	
208/240/480	196565	N/A	196590
240/480/575	196565	196589	196590
480/575	196588	196566	196590

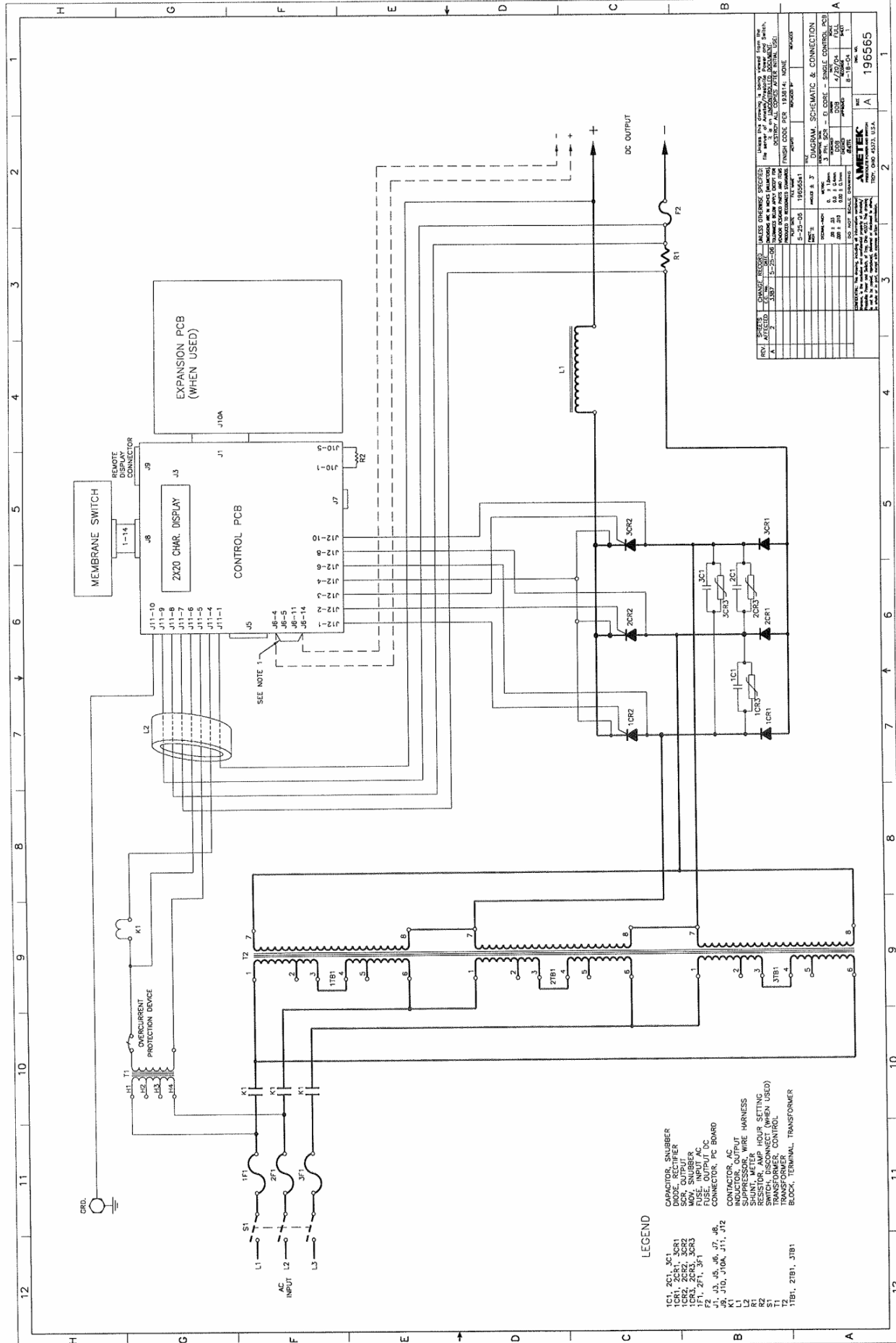

REV.	DATE	BY	CHKD.	DESCRIPTION
1	12-25-56			ISSUED FOR PRODUCTION
2	12-25-56			REVISIONS TO BE MADE BY THE MANUFACTURING DEPARTMENT
3	12-25-56			REVISIONS TO BE MADE BY THE MANUFACTURING DEPARTMENT
4	12-25-56			REVISIONS TO BE MADE BY THE MANUFACTURING DEPARTMENT
5	12-25-56			REVISIONS TO BE MADE BY THE MANUFACTURING DEPARTMENT
6	12-25-56			REVISIONS TO BE MADE BY THE MANUFACTURING DEPARTMENT
7	12-25-56			REVISIONS TO BE MADE BY THE MANUFACTURING DEPARTMENT
8	12-25-56			REVISIONS TO BE MADE BY THE MANUFACTURING DEPARTMENT
9	12-25-56			REVISIONS TO BE MADE BY THE MANUFACTURING DEPARTMENT
10	12-25-56			REVISIONS TO BE MADE BY THE MANUFACTURING DEPARTMENT
11	12-25-56			REVISIONS TO BE MADE BY THE MANUFACTURING DEPARTMENT
12	12-25-56			REVISIONS TO BE MADE BY THE MANUFACTURING DEPARTMENT

- LEGEND**
- 1C1, 2C1, 3C1 CAPACITOR, SNUBBER
 - 1CR1, 2CR1, 3CR1 DIODE, RECTIFIER
 - 1CR2, 2CR2, 3CR2 DIODE, RECTIFIER
 - 1CR3, 2CR3, 3CR3 DIODE, RECTIFIER
 - 1F1, 2F1, 3F1 FUSE, OUTPUT DC
 - J1, J2, J3, J4, J5, J6, J7, J8 CONNECTOR, PC BOARD
 - L1, L2, L3 INDUCTOR, OUTPUT
 - M1, M2 SHUNT METER
 - R1, R2 RESISTOR, AMP HOUR SETTING
 - S1, S2 SWITCH, MEMBRANE SWITCH (WHEN USED)
 - T1 TRANSFORMER, CONTROL
 - 1T1, 2T1, 3T1 TRANSFORMER, TRANSFORMER

196565

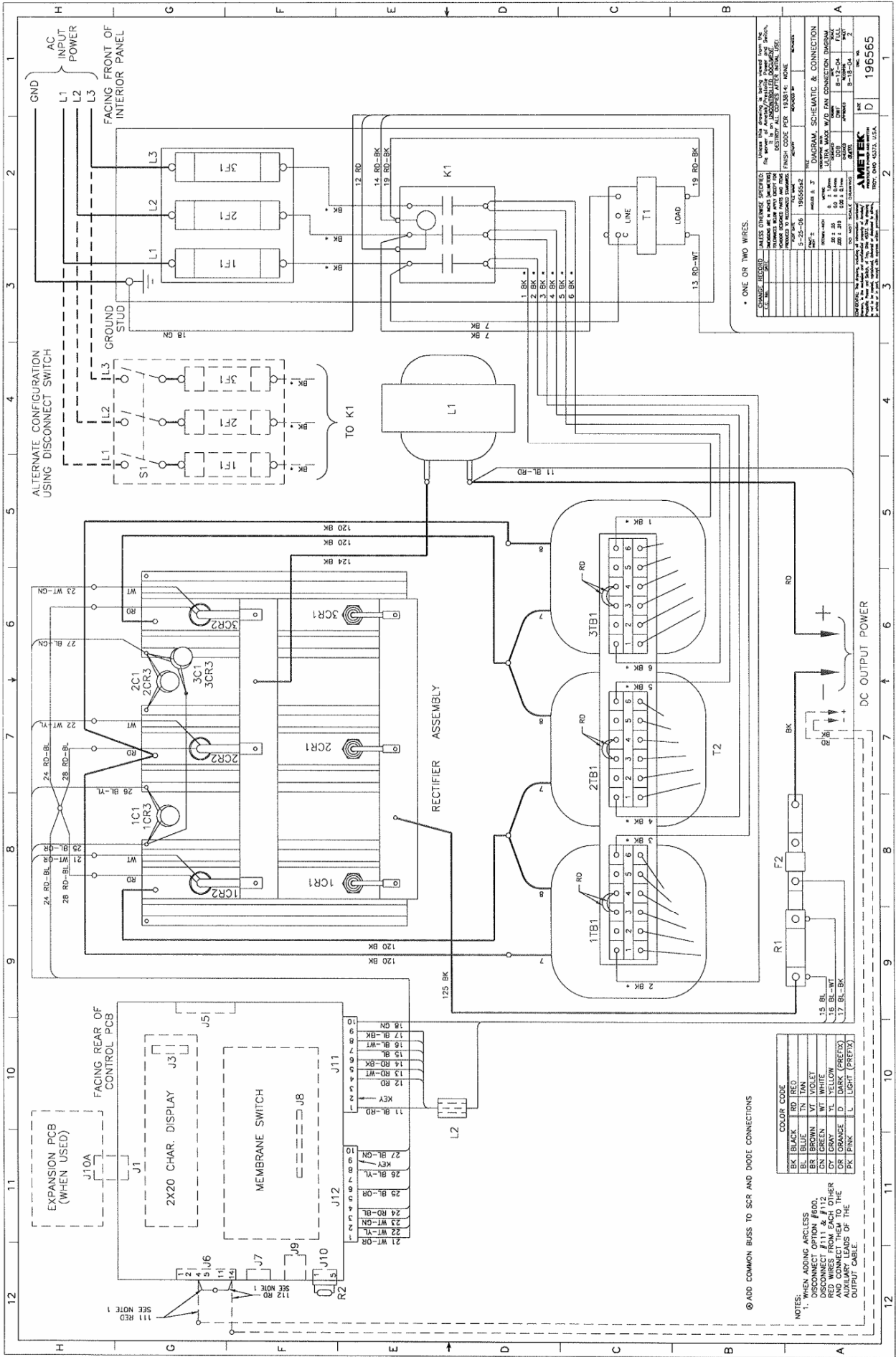

* ONE OR TWO WIRES.

CHANGE REQUEST (PLEASE INDICATE REVISION)
 U.S. MODEL NUMBER: 19650502
 U.S. MODEL NUMBER: 19650502
 U.S. MODEL NUMBER: 19650502
 U.S. MODEL NUMBER: 19650502

REVISION	DATE	BY	DESCRIPTION
1	5-25-68		ISSUE DRAWING (REVISED)
2			REVISIONS TO BE MADE (REVISIONS TO BE MADE)
3			REVISIONS TO BE MADE (REVISIONS TO BE MADE)
4			REVISIONS TO BE MADE (REVISIONS TO BE MADE)
5			REVISIONS TO BE MADE (REVISIONS TO BE MADE)
6			REVISIONS TO BE MADE (REVISIONS TO BE MADE)

DIAGRAM, SCHEMATIC & CONNECTION
 ULTRA MAX W/O PAN CONNECTION DIAGRAM
 PART NO. 19650502
 PART NO. 19650502
 PART NO. 19650502
 PART NO. 19650502

AMETEK
 19650502
 19650502
 19650502

COLOR CODE

BK	BLACK	RD	RED
BL	BLUE	TY	TAN
BR	BROWN	VT	VIOLET
DN	DARK GREEN	WT	WHITE
DR	DARK BROWN	YL	YELLOW
FK	PINK	ZE	ZEBRA
L	LIGHT	PREFFX	PREFFX

NOTES:
 1. WHEN ADDING ACCESSORIES, DISCONNECT J11 & J12 FROM THE MAIN POWER SUPPLY AND CONNECT THEM TO THE AUXILIARY LEADS OF THE OUTPUT CABLE.

⊕ ADD COMMON BUSS TO SCR AND DIODE CONNECTIONS

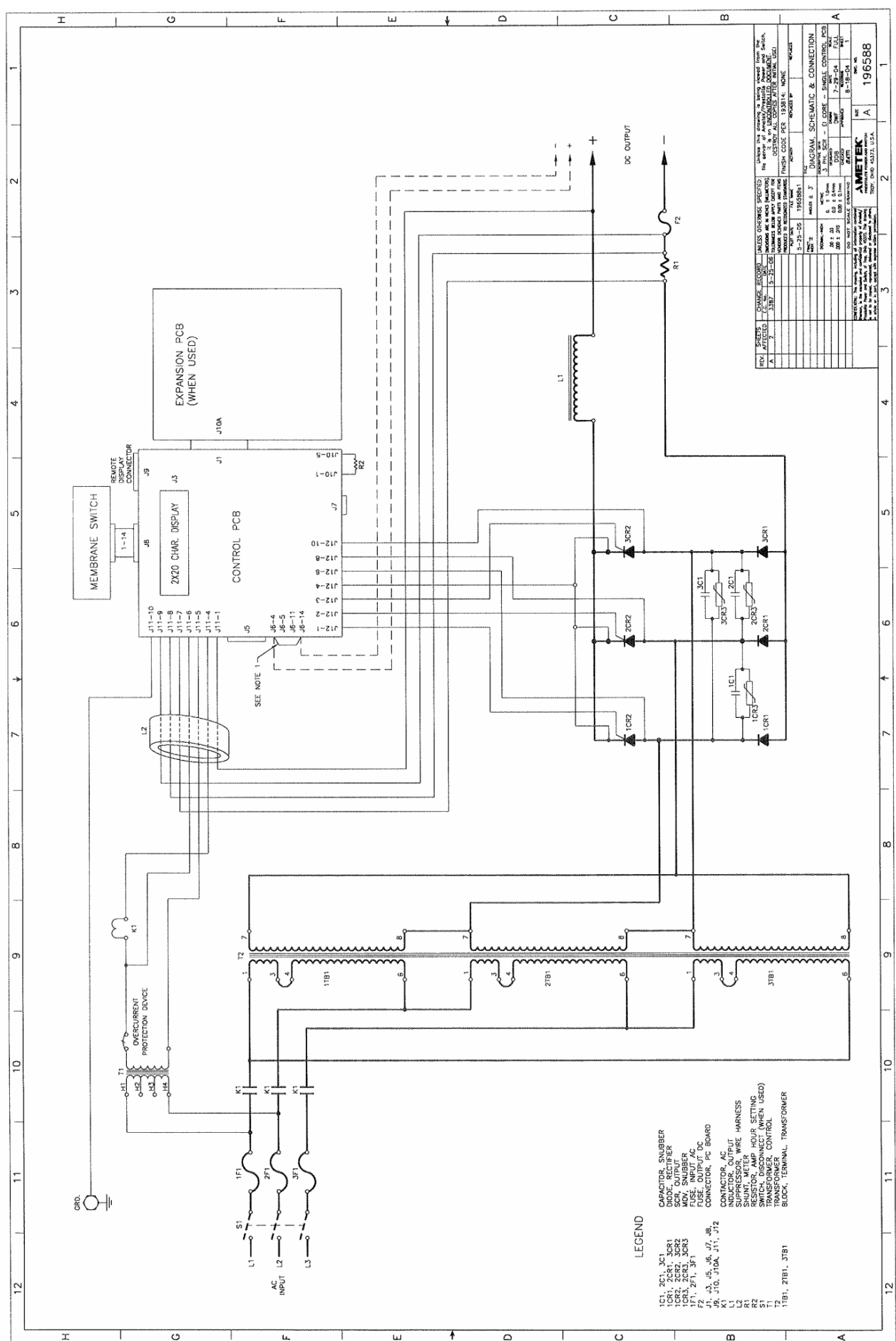

REV	SHEETS	CHANGE	REASON	DATE	BY	CHKD	APP'D	WORKST
A	2	1	INITIAL	11/17/58	J. J. ...	J. J. ...	J. J. ...	J. J. ...
A	2	2	REVISION	11/17/58	J. J. ...	J. J. ...	J. J. ...	J. J. ...

DIAGRAM SCHEMATIC & CONNECTION	
NO. 1	1181, 2181, 3181
NO. 2	1181, 2181, 3181
NO. 3	1181, 2181, 3181
NO. 4	1181, 2181, 3181
NO. 5	1181, 2181, 3181
NO. 6	1181, 2181, 3181
NO. 7	1181, 2181, 3181
NO. 8	1181, 2181, 3181
NO. 9	1181, 2181, 3181
NO. 10	1181, 2181, 3181
NO. 11	1181, 2181, 3181
NO. 12	1181, 2181, 3181

LEGEND

- 1C1, 2C1, 3C1 CAPACITOR, ANILINER
- 1CR1, 2CR1, 3CR1 DIODE, RECTIFIER
- 1CR2, 2CR2, 3CR2 SCR, OUTPUT
- 1CR3, 2CR3, 3CR3 DIODE, RECTIFIER
- 1F1, 2F1, 3F1 FUSE, INPUT AC
- J1, J3, J5, J6, J7, J8, J9, J10, J10A CONNECTOR, PC BOARD
- K1, K2 CONTACTOR, AC
- L1 INDUCTOR, OUTPUT SUPPRESSOR
- R1 RESISTOR, SHUNT, METER
- T1, T2 TRANSFORMER, AUTO-SETTING
- 1T1, 2T1, 3T1 TRANSFORMER, CONTROL
- 1181, 2181, 3181 BUCK, TERMINAL, TRANSFORMER

AMETEK
 196588

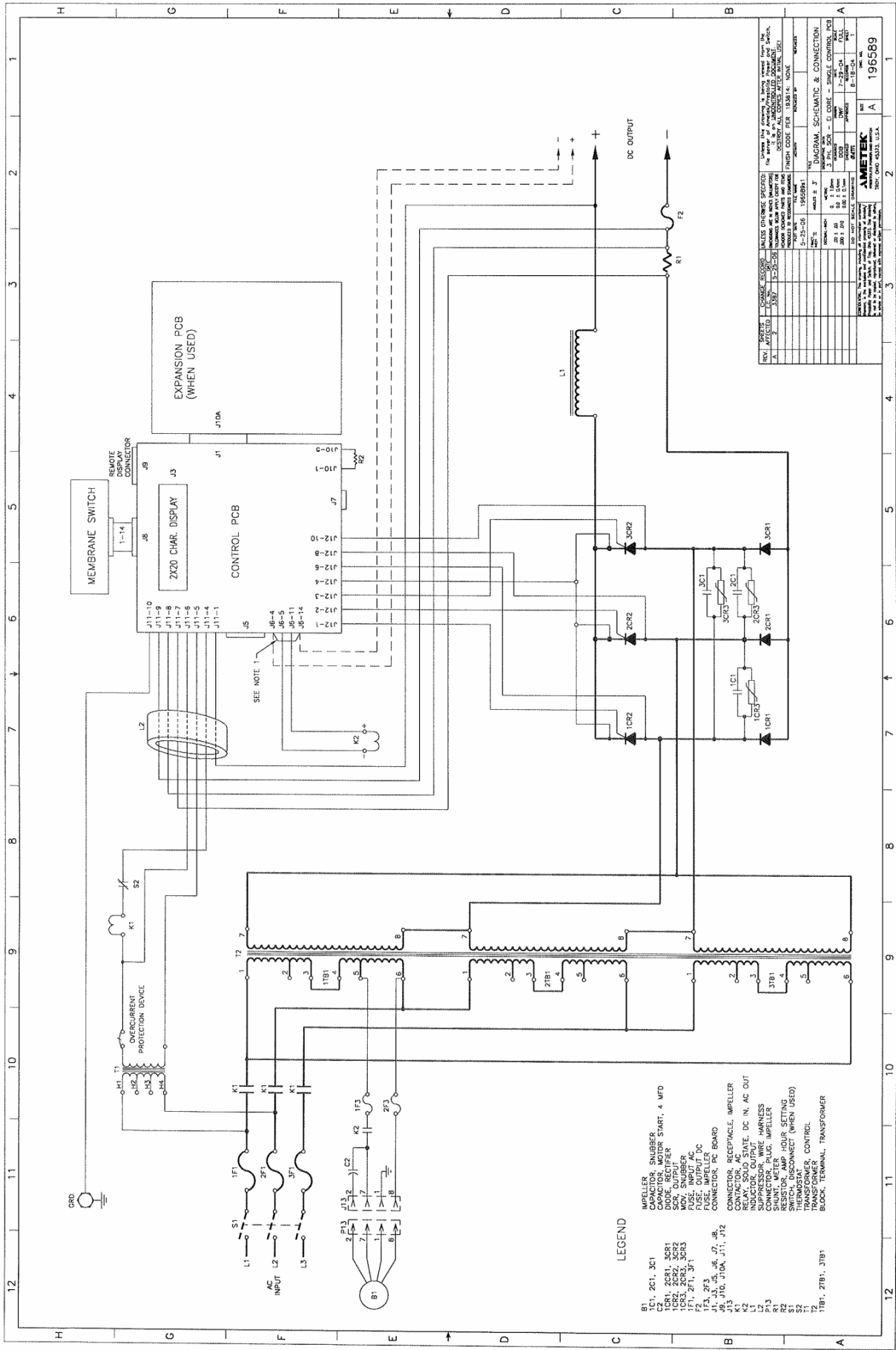

REV SHEETS CHANGE RECORD UNLESS OTHERWISE SPECIFIED: Changes that require a being noted from the original drawing are shown in parentheses. Changes that do not require a being noted from the original drawing are shown in brackets. Changes that require a being noted from the original drawing are shown in brackets and are indicated by a checkmark in the revision column.

REV	DATE	BY	CHKD	DESCRIPTION
1	11-15-58	J. J. W.	J. J. W.	INITIAL DESIGN FOR PRODUCTION
2	12-15-58	J. J. W.	J. J. W.	REVISION TO CORRECT DRAWING ERRORS
3	1-15-59	J. J. W.	J. J. W.	REVISION TO CORRECT DRAWING ERRORS
4	2-15-59	J. J. W.	J. J. W.	REVISION TO CORRECT DRAWING ERRORS
5	3-15-59	J. J. W.	J. J. W.	REVISION TO CORRECT DRAWING ERRORS
6	4-15-59	J. J. W.	J. J. W.	REVISION TO CORRECT DRAWING ERRORS
7	5-15-59	J. J. W.	J. J. W.	REVISION TO CORRECT DRAWING ERRORS
8	6-15-59	J. J. W.	J. J. W.	REVISION TO CORRECT DRAWING ERRORS
9	7-15-59	J. J. W.	J. J. W.	REVISION TO CORRECT DRAWING ERRORS
10	8-15-59	J. J. W.	J. J. W.	REVISION TO CORRECT DRAWING ERRORS
11	9-15-59	J. J. W.	J. J. W.	REVISION TO CORRECT DRAWING ERRORS
12	10-15-59	J. J. W.	J. J. W.	REVISION TO CORRECT DRAWING ERRORS

THE DIAGRAM SCHEMATIC & CONNECTION:
 1. 1PH. SCHEMATIC - SINGLE CONTROL PCB
 2. 2PH. SCHEMATIC - SINGLE CONTROL PCB
 3. 3PH. SCHEMATIC - SINGLE CONTROL PCB
 4. 4PH. SCHEMATIC - SINGLE CONTROL PCB
 5. 5PH. SCHEMATIC - SINGLE CONTROL PCB
 6. 6PH. SCHEMATIC - SINGLE CONTROL PCB
 7. 7PH. SCHEMATIC - SINGLE CONTROL PCB
 8. 8PH. SCHEMATIC - SINGLE CONTROL PCB
 9. 9PH. SCHEMATIC - SINGLE CONTROL PCB
 10. 10PH. SCHEMATIC - SINGLE CONTROL PCB
 11. 11PH. SCHEMATIC - SINGLE CONTROL PCB
 12. 12PH. SCHEMATIC - SINGLE CONTROL PCB

AMETEK
 1000 OHIO AVENUE, CINCINNATI, OHIO 45202, U.S.A.
 196589

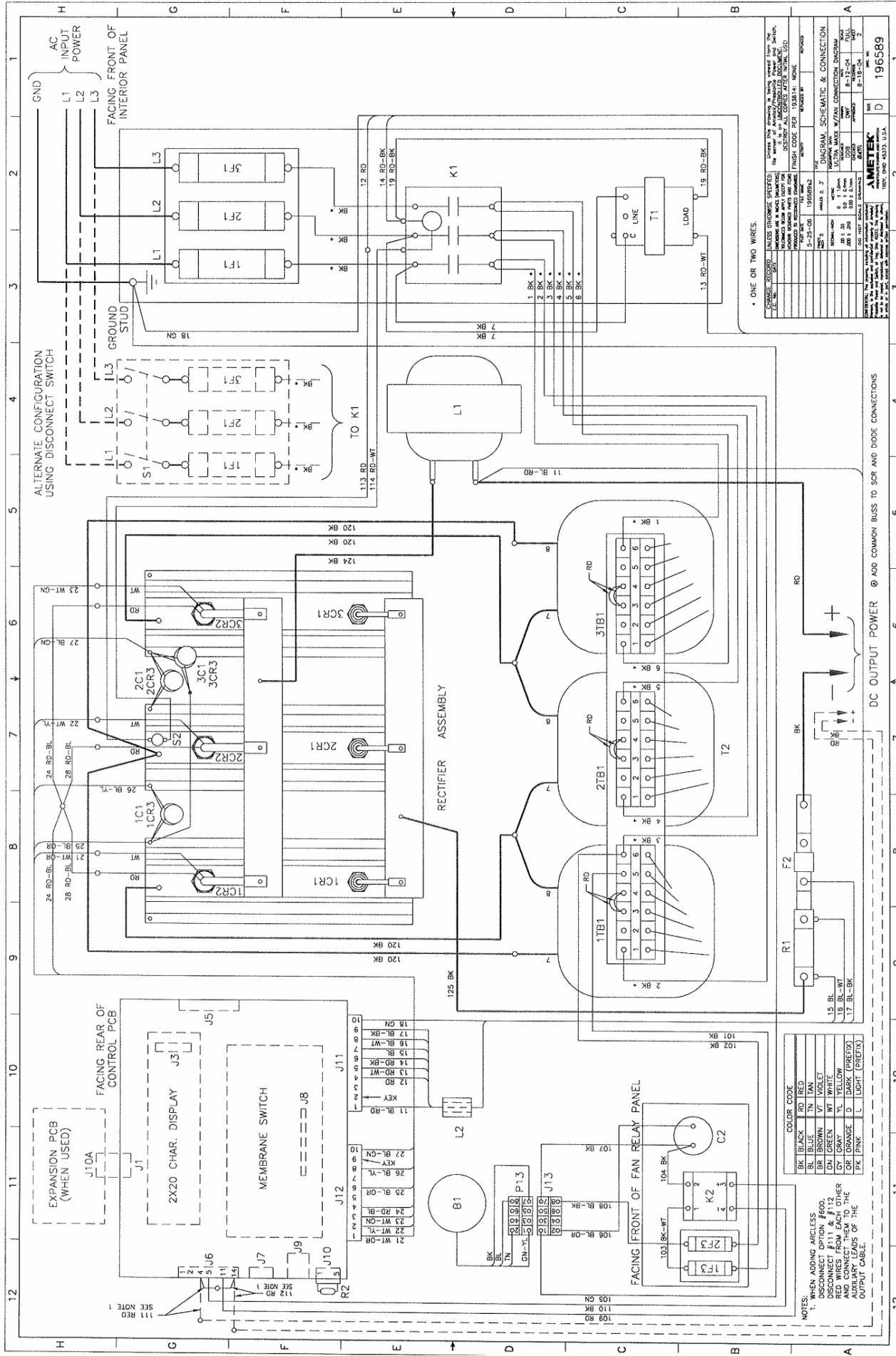

• ONE OR TWO WIRES.

WIRE GAUGE (AWG) TABLE

WIRE GAUGE (AWG)	DIAGRAM SYMBOL	WIRE COLOR	WIRE TYPE
18	○	BLK	18 AWG
20	○	BRN	20 AWG
22	○	GRN	22 AWG
24	○	WHT	24 AWG
26	○	GRY	26 AWG
28	○	YEL	28 AWG
30	○	DRK	30 AWG
32	○	PRNK	32 AWG
34	○	LT	34 AWG

DIAGRAM SYMBOLS & CONNECTIONS

DIAGRAM SYMBOL	WIRE COLOR	WIRE TYPE
○	BLK	18 AWG
○	BRN	20 AWG
○	GRN	22 AWG
○	WHT	24 AWG
○	GRY	26 AWG
○	YEL	28 AWG
○	DRK	30 AWG
○	PRNK	32 AWG
○	LT	34 AWG

COLOR CODE TABLE

COLOR	WIRE COLOR	WIRE TYPE
BLK	BLK	18 AWG
BLU	BLU	18 AWG
BRN	BRN	20 AWG
GRN	GRN	22 AWG
WHT	WHT	24 AWG
GRY	GRY	26 AWG
YEL	YEL	28 AWG
DRK	DRK	30 AWG
PRNK	PRNK	32 AWG
LT	LT	34 AWG

NOTES:
 1. WHEN ADDING ACCESS DISCONNECT OPTION #100, DISCONNECT #111 & #112 RED WIRES FROM EACH OTHER AND THE OTHER RED ADJUTARY LEADS OF THE OUTPUT CABLE.

DC OUTPUT POWER @ ADD COMMON BUSS TO SCR AND DIODE CONNECTIONS

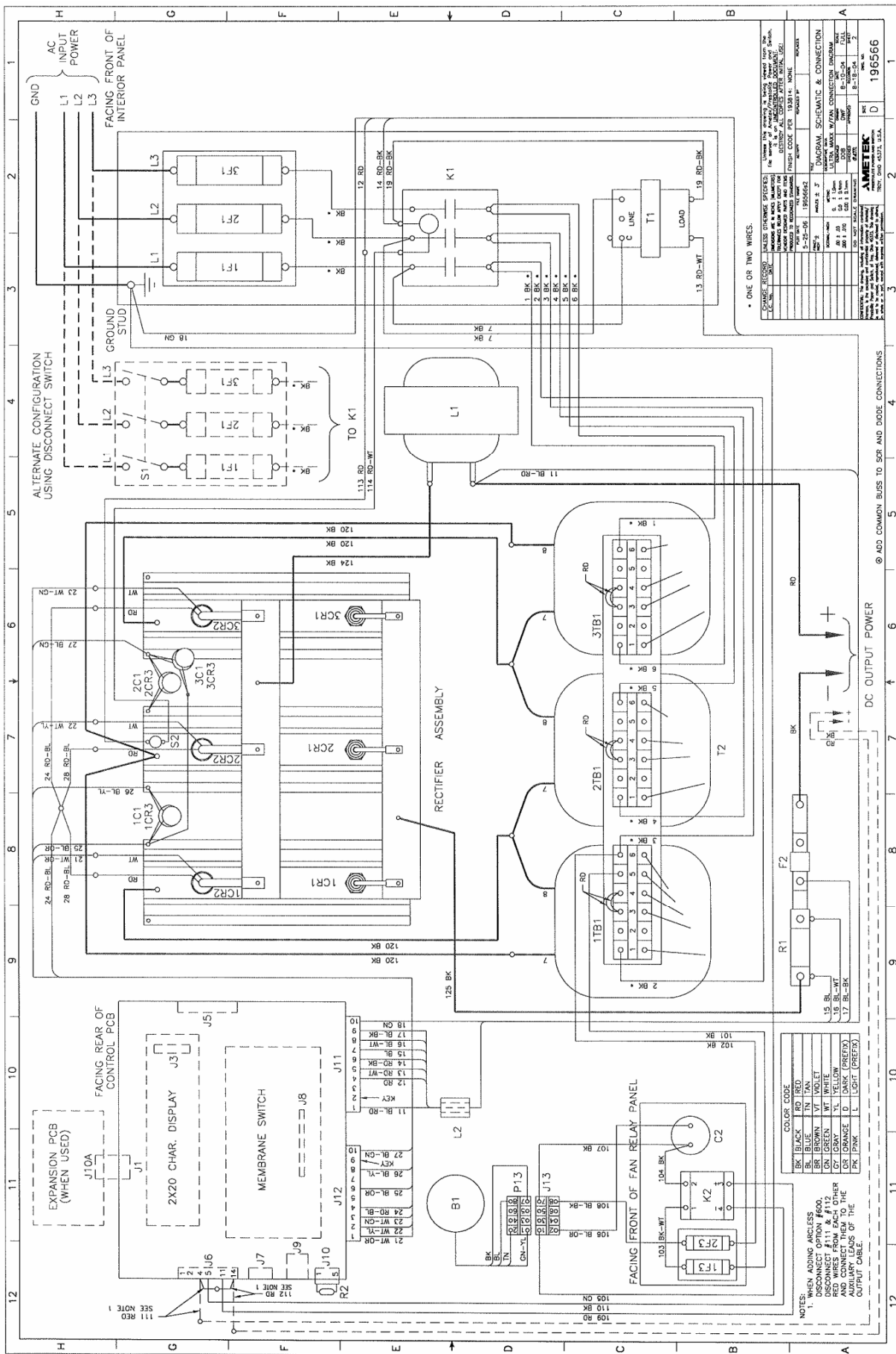

AMETEK

196566

DIAGRAM SCHEMATIC & CONNECTION

ULTRA-MAX W/FA CONNECTION

DATE: 8-13-54

DESIGNER: J. J. ...

APP'D: ...

REVISIONS:

NO.	DATE	DESCRIPTION
1	8-13-54	...
2

* ONE OR TWO WIRES.

© ADD COMMON BUSS TO SER AND DIODE CONNECTIONS



WARRANTY

AMETEK/PRESTOLITE POWER "SCR" INDUSTRIAL BATTERY CHARGERS

Ametek/Prestolite Power (hereinafter called "Prestolite") warrants that each new and unused Industrial Battery Charger manufactured and supplied by it is of good workmanship and is free from any inherent mechanical defects, provided that (1) the product is installed and operated in accordance with generally accepted industrial standards and in accordance with the printed instructions of Prestolite, (2) the product is used under normal conditions for which designed, (3) the product is not subjected to misuse, negligence or accident, and (4) the product receives proper care, protection and maintenance under supervision of competent personnel. This warranty is subject to the following provisions:

1. **PRODUCT AND PARTS WARRANTED.** Subject to the exceptions listed below each Industrial Battery Charger is warranted for a specific period of time commencing from the date of it's shipment by Prestolite, provided the charger is used in accordance with Prestolite's published performance rating for the unit involved. The exceptions to this warranty are as follows:

a) Terms and conditions for warranty coverage:

<u>SCR PRODUCTS</u>	ULTRA MAXX	ULTRA CHARGE	POWER STAR	POWERSTAR PLUS
FULL COVERAGE - LABOR, TRAVEL, MILEAGE & PART REPLACEMENT	1-year	1-year	1-year	1-year
PRINTED CIRCUIT BOARD (REPLACEMENT ONLY)	2-years additional	2-years additional	2-years additional	2-years additional
TRANSFORMER, INDUCTOR, SCR & DIODE (REPLACEMENT ONLY)	9-years additional	9-years additional	9-years additional	9-years additional
TOTAL WARRANTY TERM (YEARS)	10-years	10-years	10-years	10-years

b) Warranty Expense Limitation: The maximum warranty expense Prestolite will incur for any Battery Charger will be limited to the original purchase price of the Battery Charger.

c) Primary switch contacts, fuses, bulbs and filters are not warranted unless found to be defective prior to use.

2. **COMMENCEMENT OF WARRANTY TIME PERIODS.** The warranty periods indicated in the Warranty Schedule shall commence on the date of shipment by Prestolite.
3. **PERSONS COVERED BY WARRANTY.** Prestolite extends this warranty only to the purchaser of new equipment from Prestolite or one of its authorized distributors. The products purchased under this agreement shall be used exclusively by the buyer and its employees and by no other persons; and therefore there shall be no third party beneficiary to this warranty.
4. **LIMITATION OF REMEDY.** The existence of claimed defects in any product covered by this warranty is subject to Prestolite's factory inspection and judgement. Prestolite's liability is limited to repair of any defects found by Prestolite to exist or, at Prestolite's option, the replacement of the defective product F.O.B. factory after the defective product has been returned by the purchaser at its expense to Prestolite's shipping place. Replacement and exchange parts will be warranted for the remainder of the original Industrial Battery Charger Warranty or for a period of ninety (90) days, whichever is greater.
5. **USE OF DEFECTIVE PRODUCT.** Continued use of an Industrial Battery Charger after discovery of a defect **VOIDS ALL WARRANTIES.**
6. **ALTERED EQUIPMENT.** Except as authorized in writing, the warranty specified does not cover any equipment that has been altered by any party other than Prestolite.

THIS WARRANTY IS GIVEN AND ACCEPTED IN LIEU OF ALL OTHER WARRANTIES, WHETHER EXPRESS OR IMPLIED, INCLUDING WITHOUT LIMITATION ANY WARRANTIES OF MERCHANTABILITY OR FITNESS FOR A PARTICULAR PURPOSE, OTHER THAN AS EXPRESSLY SET FORTH HEREIN. IN NO EVENT SHALL PRESTOLITE BE LIABLE FOR ANY ANTICIPATED OR LOST PROFITS, SPECIAL, DIRECT, INDIRECT OR INCIDENTAL DAMAGES, CONSEQUENTIAL DAMAGES, TIME CHARGES OR OTHER COMMERCIAL EXPENSES OR LOSSES, AND BUYER ASSUMES ALL RISK AND LIABILITY RESULTING FROM USE OF THE GOODS. PRESTOLITE DOES NOT AUTHORIZE ANY REPRESENTATIVE OR OTHER PERSON TO ASSUME ON BEHALF OF PRESTOLITE ANY OTHER LIABILITY IN CONNECTION WITH THE SALE OR USE OF THE GOODS SOLD, AND THERE ARE NO ORAL AGREEMENTS OR WARRANTIES COLLATERAL TO OR AFFECTING THIS WRITTEN WARRANTY.

WARNING

At all times, safety must be considered an important factor in the installation, servicing and operation of the product and skilled, qualified technical assistance should be utilized.

AMETEK/PRESTOLITE POWER - TROY, OHIO USA

Data Sheet: 1148
 Index: 060110
 Replaces: 030105