

# **OWNER'S MANUAL 193111-051**

Issued August 9, 2002

---

**IMPORTANT:** Read these instructions before installing, operating, or servicing this system.

---

## **POWER PRO FERRO 60 SERIES CHARGERS**

**Silicon Diode Ferroresonant  
Transformer Type  
Battery Charger**

**DO NOT DESTROY**



**NOTE:** Information regarding obtaining additional copies of this manual is located in the Introduction chapter of this manual.

A battery charger is identified by model number. Incorporated into the model number is the 8-hour ampere-hour capacity, case size, input power phase, and number of cells in battery for which charger is intended. The following example explains the basic model numbering arrangement.

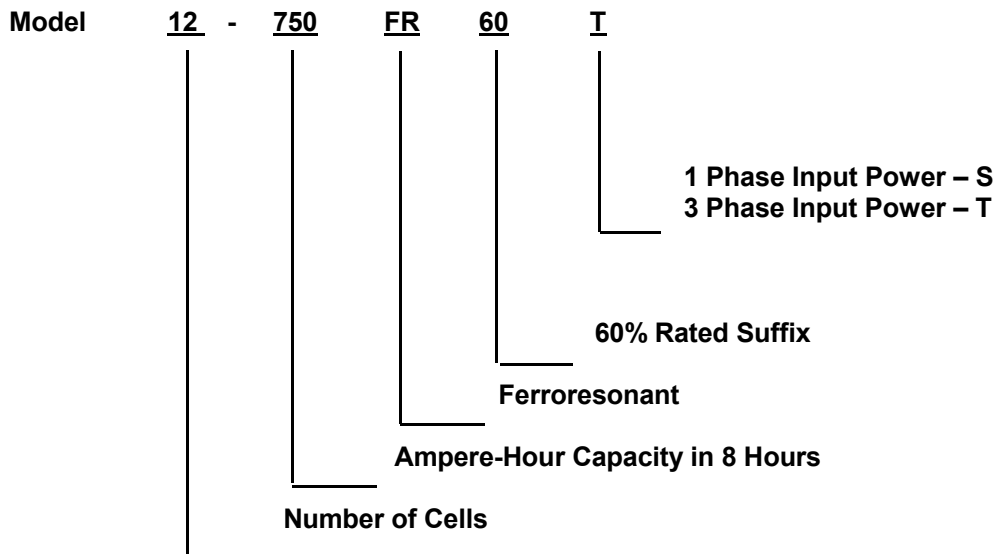

**NOTE:** This information is required for ordering certain replacement/service parts.



<b>INTRODUCTION</b> .....	<b>1</b>
How to use this Manual.....	1-1
Equipment Identification.....	1-1
Receipt of Equipment.....	1-1
<b>SAFETY INSTRUCTIONS AND WARNINGS</b> .....	<b>2</b>
<b>INITIAL SET-UP &amp; DESCRIPTION</b> .....	<b>3</b>
<b>INSTALLATION</b> .....	<b>4</b>
Location .....	4-1
Environmental Characteristics .....	4-1
Grounding .....	4-1
Line Voltage Changeover Instructions .....	4-2
Line Connections to Battery Charger.....	4-2
Charging Cable Connectors.....	4-3
Pre-operation Checks .....	4-3
<b>OPERATION</b> .....	<b>5</b>
Preliminary .....	5-1
Normal or Daily Charge .....	5-1
Equalize or Weekend Charge .....	5-2
Manual Stop.....	5-2
Refresh Charge.....	5-2
Backup Timer Shutdown.....	5-2
Battery Disconnect Shutdown.....	5-2
AC Power Fail .....	5-2
<b>MAINTENANCE</b> .....	<b>6</b>
Inspection and Cleaning .....	6-1
Lubrication .....	6-1
Fuse Replacement.....	6-1
Silicon Diode Testing .....	6-1
Capacitor Testing .....	6-2
Troubleshooting .....	6-3
<b>PARTS LIST</b> .....	<b>7</b>
<b>DIAGRAMS</b>	
<b>WARRANTY</b>	

This page intentionally left blank.

# INTRODUCTION

## How To Use This Manual

**IMPORTANT:** It is especially important that all charger internal components be kept clean and dry, and all electrical connections as tightened as instructed in the Maintenance chapter of this manual. Replace any precautionary or instruction label that cannot be easily read.

Throughout this manual, the words **WARNING**, **CAUTION**, and **NOTE** may appear. Pay particular attention to the information provided under these headings. These special annotations are easily recognized as follows:

**WARNING** gives information regarding possible personal injury. Warnings will be enclosed in a box such as this.

**CAUTION** refers to possible equipment damage. Cautions will be shown in bold type.

*NOTE* offers helpful information concerning certain operating procedures. Notes will be shown in italics.

## Equipment Identification

The unit's identification number (specification, model, serial number) usually appears on a nameplate attached to the front panel.

## Receipt Of Equipment

When you receive the equipment, check it against the invoice to make sure it is complete and inspect the equipment for possible damage due to shipping. If there is any damage, notify the carrier immediately to file a claim. Furnish complete information concerning damage claims or shipping errors to the company shown on the cover of this manual. Include all equipment identification numbers and group part numbers (if any) as described above along with a full description of the parts in error.

Move the equipment to the site of installation before uncrating. Use care to avoid damaging the equipment when using bars, hammers, etc., to uncrate the unit.

Additional copies of this manual may be purchased by contacting Ametek/Prestolite Power Troy OH 45373, include the Owner's Manual number and equipment identification numbers.

**This page intentionally left blank.**



# SAFETY INSTRUCTIONS AND WARNINGS

## FOR OPERATION OF BATTERY CHARGING EQUIPMENT

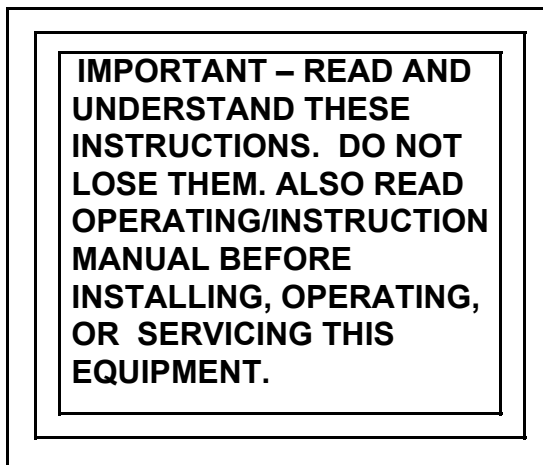

### A. General

Battery charging products can cause serious injury or death, or damage to other equipment or property, if the operator does not strictly observe all safety rules and take precautionary actions.

Safe practices have developed from past experience in the use of charging equipment. These practices must be learned through study and training before using this equipment. Anyone not having extensive training in battery charging practices should be taught by experienced operators.

Only qualified personnel should install, use, or service this equipment.

### B. Shock Prevention

Bare conductors, or terminals in the output circuit, or ungrounded, electrically-live equipment can fatally shock a person. To protect against shock, have competent electrician verify that the equipment is adequately grounded and learn what terminals and parts are electrically HOT.

The body's electrical resistance is decreased when wet, permitting dangerous current to flow through the body. Do not work in damp area without being extremely careful. Stand on dry rubber mat or dry wood and use insulating gloves when dampness or sweat cannot be avoided. Keep clothing dry.

1. Installation and Grounding of Electrically Powered Equipment – Electrical equipment must be installed and maintained in accordance with the National Electrical Code, NFPA 70, and local codes. A power disconnect switch must be located at the equipment. Check nameplate for voltage and phase requirements. If only 3-phase power is available, connect *single-phase* equipment to only two wires of the 3-phase line. DO NOT CONNECT the equipment grounding conductor (lead) to the third live wire of the 3-phase line as this makes the equipment frame electrically HOT, which can cause a fatal shock.

If a grounding lead (conductor) is part of the power supply cable, be sure to connect it to a properly grounded switch box or building ground. If not part of the supply cable, use a separate grounding lead (conductor). Do not remove a ground prong from any plug. Use correct mating receptacles. Check ground for electrical continuity before using equipment.

The grounding conductor must be of a size equal to or larger than the size recommended by Code or in this manual.

2. Charging Leads – Inspect leads often for damage to the insulation. Replace or repair cracked or worn leads immediately. Use leads having sufficient capacity to carry the operating current without overheating.
3. Battery Terminals – Do not touch battery terminals while equipment is operating.
4. Service and Maintenance – Shut OFF all power at the disconnect switch or line breaker *before* inspecting, adjusting, or servicing the equipment. Lock switch OPEN (or remove line fuses) so that the power cannot be turned ON accidentally. Disconnect power to equipment if it is to be left unattended or out of service.

Disconnect battery from charger. Measure voltage on capacitors and discharge through an insulated screwdriver if there is any voltage reading.

Keep inside parts clean and dry. Dirt and/or moisture can cause insulation failure. This failure can result in high voltage at the charger output.

### C. Burn and Bodily Injury Prevention

The battery produces very high currents when short circuited, and will burn the skin severely if in contact with any metal conductor that is carrying this current. Do not permit rings on fingers to come in contact with battery terminals or the cell connectors on top of the battery.

Battery acid is very corrosive. Always wear correct eye and body protection when near batteries.

### D. Fire and Explosion Prevention

Batteries give off explosive flammable gases which easily ignite when coming in contact with an open flame or spark. Do not smoke, cause sparking, or use open flame near batteries. Charge batteries only in locations which are clean, dry, and well ventilated. Do not lay tools or anything that is metallic on top of any battery. All repairs to a battery must be made only by experienced and qualified personnel.

### E. Arcing and Burning of Connector

To prevent arcing and burning of the connector contacts, be sure the charger is OFF before connecting or disconnecting the battery. (If the charger is equipped with an ammeter, the ammeter should not indicate current flow.) Always connect battery before turning charger ON.

### F. Medical and First Aid Treatment

First aid facilities and a qualified first aid person should be available for each shift for immediate treatment of electrical shock victims.

**EMERGENCY FIRST AID: Call physician and ambulance immediately. Use First Aid techniques recommended by the American Red Cross.**

**DANGER: ELECTRICAL SHOCK CAN BE FATAL. If person is unconscious and electric shock is suspected, do not touch person if he or she is in contact with charging leads, charging equipment, or other live electrical parts. Disconnect (open) power at wall switch and then use First Aid. Dry wood, wooden broom, and other insulating material can be used to move cables, if necessary, away from person. IF BREATHING IS DIFFICULT, give oxygen. IF NOT BREATHING, BEGIN ARTIFICIAL BREATHING, such as mouth-to-mouth. IF PULSE IS ABSENT, BEGIN ARTIFICIAL CIRCULATION, such as external heart massage.**

IN CASE OF ACID IN THE EYES, flush very well with clean water and obtain professional medical attention immediately.

### G. Equipment Warning Labels

Inspect all precautionary labels on the equipment. Order and replace all labels that cannot be easily read.

# INITIAL SET-UP & DESCRIPTION

## Charger

The basic charging circuit is the silicon diode, rectifier-type with ferroresonant transformer (s). This ferroresonant transformer design regulates charging current by allowing the battery to determine its own charge cycle rate in accordance with its state of discharge. It provides a constantly-tapering charge that eliminates the possibility of overcharging, even with line voltage variations of  $\pm 10\%$ . Single-phase input chargers have one transformer, three-phase input chargers have two. The charger is internally protected from overload and short circuits.

When charging lead acid batteries, with the same number of cells and ampere-hour capacity as shown on charger nameplate, the charging time will be approximately 8 hours. Batteries of smaller or larger ampere-hour capacities can also be charged, but will require shorter or longer charging, respectively.

**WARNING: Do not connect a battery to this charger if any LED is lit. Do not disconnect a battery from this charger while a charge is in progress. Otherwise, arcing and burning of connector parts or a battery explosion may result. Batteries produce explosive gases. Keep sparks, flame, and cigarettes away. Ventilate when charging in an enclosed area. Always shield eyes when working near batteries.**

## Set-Up

See [Location Diagram of Selector Switches](#) included in this manual.

For proper operation, the Control must be set to match the charger in which it is installed.

## Cell Size Selection

From the data plate on the charger, note the voltage output. Place the corresponding DIP switch (S1) on the Control in the "Closed" position.

S1-1	12 Volts
S1-2	24 Volts
S1-3	36 Volts
S1-4	48 Volts
S1-5	Optional

Only one of the above DIP switches should be in the "Closed" position at any one time.

## Auto Equalize

Switch S1-6 can be used to select either Auto Equalize or Manual Equalize.

S1-6	Equalize Type
Open	Auto Equalize every 5th Cycle
Closed	Manual Equalize

## Termination Type

Switch S1-7 can be used to select either 2.37 V/C or 2.45 V/C 80% Trip Point.

S1-7	80% V/C
Open	2.37
Closed	2.45

## Charger Control

The Control has an on board microcontroller to monitor and control the charging process. The up-to-date status of the charge cycle can be easily monitored by watching the status of the four LED's, charge in progress, 80% charged, charge complete, and equalize. The Control utilizes a patented pt/dv/dt charge termination technique which eliminates excessive gassing by returning approximately 107% of the amp-hours removed from the battery.

All front panel information (including operation instructions) is back printed on a polycarbonate overlay which is resistant to damage from oils, gasoline, and frequent operator handling. The Control is "matched" to the output voltage of the charger by means of a printed circuit board mounted DIP switch. Features of the Control include Auto Start/Stop, Auto/Manual Equalize, Manual Stop, Backup Timer Protection, pt/dv/dt Termination Method, 2.37 V/C & 2.45 V/C 80% Point, 48 Hour Refresh, and AC Power Fail Recovery.

## FERRO SERIES CONTROL DIP SWITCHES

### DIP SWITCHES

- S1-1 12 VOLT
- S1-2 24 VOLT
- S1-3 36 VOLT
- S1-4 48 VOLT
- S1-5 OPTIONAL VOLT
- S1-6 AUTO EQUALIZE
- S1-7 80% POINT
- S1-8 NOT USED
- S1-9 NOT USED
- S1-10 NOT USED

  
 CLOSED POSITION      OPEN POSITION



VIEW FROM  
TOP OF CONTROL

# INSTALLATION

## Location

For best operating characteristics and longest unit life, take care in selecting an installation site. Avoid locations exposed to high humidity, dust, high ambient temperature, or corrosive fumes. Moisture can condense on electrical components, causing corrosion or shorting of circuits (especially when dirt is also present).

Adequate air circulation is needed at all times in order to assure proper operation. Provide a minimum of 6 inches of free air space at rear and sides of the unit. Make sure that ventilation openings are not obstructed.

Always remove the charger shipping skid from the unit before installation. The charger must be installed over a noncombustible surface such as concrete or metal. Keep the charging area clear of all combustible material such as wood, paper, and cloth.

**WARNING: SPARKS OR MOLTEN METAL falling through open bottom can cause fire or explosion.**

- **Install over noncombustible material such as concrete or metal.**
- **Keep charging area clear of combustible material.**

## Environmental Characteristics

Operating Characteristics	0°C to 40°C (32°F to 104°F)
Operating Altitude	To 2000 Meters (6562 Feet)
Operating Humidity	80% up to 31°C, decreasing to 50% at 40°C, non-condensing  80% up to 88°F decreasing to 50% at 104°F, non-condensing

## Grounding

The frame of the power source must be grounded for personnel safety. Where grounding is mandatory under state or local codes, it is the responsibility of the user to comply with all applicable rules and regulations. Where no state or local codes exist, it is recommended that the National Electrical Code be followed.

In addition to the usual function of protecting personnel against the hazard of electrical shock due to fault in the equipment, grounding serves to discharge the static electrical charges which tend to build up on the surfaces of equipment. These static charges can cause painful shock to personnel, and can lead to the erroneous conclusion that an electrical fault exists in the equipment.

If a charger is to be connected to the AC power supply with a flexible jacketed cable, one having a separate grounding conductor should be used. When included in cable assembly, grounding conductor will be green, green with a yellow stripe, or bare. When connecting input power to charger (as instructed in Line Connection to Battery Charger section of this manual), connect grounding conductor to equipment grounding terminal (stud with a green nut and a cup washer and identified by symbol  $\equiv$ ), taking care to make a good electrical connection. Connect other end of grounding conductor to the system ground.

If, for any reason, an input cable which does not include a grounding conductor is used, the equipment must be grounded with separate conductor. Minimum size and color coding requirements must be in accordance with any applicable state or local code, or the National Electrical Code.

If metallic armored cable or conduit is used, the metal sheathing or conduit must be effectively grounded as required by state or local code, or the National Electrical Code.

If a system ground is not available, the charger frame must be connected to a driven ground rod (at least 8 ft [2438 mm] long), or to a water pipe that enters the ground not more than 10 ft (3048 mm) from the charger. A grounding conductor must be connected to the rod or pipe in a manner that will assure a permanent and effective ground. The conductor must be sized in accordance with any applicable state or local code, or by the National Electrical Code. If in doubt, use the same size conductor as is used for the conductors supplying power to the charger.

**WARNING: ELECTRIC SHOCK HAZARD - Under no circumstance should you use a grounding conductor with a current carrying capacity less than the ampere rating shown in Table 4-1.**

LINE AMPS	DISCONNECT SWITCH *	BRANCH FUSE SIZE (AMPERES)	COPPER CABLE SIZE AWG **	
			POWER	GROUND
0-2.5	30A	5	No. 14	No. 14
2.6-4.5	30A	7	No. 14	No. 14
4.6-7.5	30A	10	No. 14	No. 14
7.6-12	30A	15	No. 14	No. 14
12.1-16	30A	20	No. 12	No. 12
16.1-18	30A	25	No. 10	No. 10
18.1-22	30A	30	No. 10	No. 10
22.1-24.5	60A	35	No. 8	No. 10
24.6-32.5	60A	40	No. 8	No. 10
32.6-40	60A	50	No. 8	No. 10
40.1-45	60A	60	No. 6	No. 10
45.1-57.5	100A	80	No. 4	No. 8
57.6-78	100A	100	No. 2	No. 8
78.1-102.5	200A	125	No. 2	No. 6
102.6-135	200A	150	No. 1/0	No. 6

**Table 4-1 Recommended AC Input and Branch Fusing**

The above table (Table 4-1) is based on 75°C (167°F) rated conductors and 40°C (104°F) ambient temperatures. Refer to National Electrical Code (1999) Tables 310-16 corrected to 40°C (104°F).

- \* For 115, 208, and 230-volt lines, use 250-volt disconnect switch.  
 For 440-480, 575-volt lines, use 600-volt disconnect switch.
- \*\* Two conductors and ground conductor required for single phase.  
 Three conductors and ground conductor required for three phase.

Recommended minimum size of grounding conductors (based on National Electrical Code 1999 – Table 250-95).

### Line Voltage Changeover Instructions

1. Determine if the charger is connected for available line voltage. A label located near AC input terminals is marked with the AC voltage for which the charger is factory connected.
2. If charger is not connected correctly, check serial nameplate to determine that charger is equipped to be connected for available line voltage. If charger is suitably equipped, make voltage changeover connections by following instructions on AC INPUT label inside charger.
3. If charger is reconnected, check input fuse (s) ratings with ratings specified on label and replace if necessary.

**CAUTION: INCORRECT CONNECTIONS AND INCORRECT FUSE SIZE can damage this equipment. Follow voltage changeover instructions carefully.**

### Line Connections to Battery Charger

Follow local code requirements if different than instructions in this manual.

1. Turn charger OFF.
2. Be sure charger is connected correctly for available line voltage as instructed above.
3. On charger nameplate, note the AC input amperes corresponding to the line voltage to which charger is to be connected. Use that ampere value to select the proper disconnect switch, fuse, and power cable sizes from Table 4-1.

4. Route AC power input cable in through knock-out provided in side panel of charger cabinet. Securely fasten cable wires to a power input terminal inside charger. Refer to Grounding section of this manual for proper connection of grounding conductor. (Charger cabinet top or side panel, or both, may have to be removed to provide access to terminal block.)
5. With disconnect switch (on AC input power line) in "OPEN" or "OFF" position, connect power cable coming from charger, to the switch. Install fuses in switch.

## Charging Cable Connectors

If connectors are already attached to charging cables, make sure that they're attached so that positive charger polarity will connect to positive battery terminal.

If connectors must be attached to charging cables, follow instructions supplied with connectors.

**CAUTION: Make sure connectors are securely attached to cables (good solder joint or well tightened set screws, whichever is applicable). Be certain that positive charger cable will connect to positive battery terminal. If necessary, trace cables into charger and use supplied connection diagram to determine polarity. The use of a DC voltmeter may show polarity. Improper connections will "blow" output fuse and may cause other damage.**

## Pre-operation Checks

1. Inspect charger thoroughly for damage; loose screws, nuts, or electrical connections.

**WARNING: ELECTRICAL SHOCK HAZARD – Before inspecting or cleaning inside cabinet, turn OFF and remove fuses of disconnect switch (supplying AC power to charger), disconnect battery, and check for voltage on capacitors. Discharge through insulated screwdriver if there is any reading.**

2. Remove all special tags that are tied to charger. Keep tags with this manual for future reference. Leave all precautionary and instruction labels in place on charger. Carefully read and follow instructions on all tags and labels. Make sure all labels remain visible to anyone operating charger.
3. Make sure all charger cabinet panels are fastened in place, to assure proper flow of ventilating air through cabinet.

**This page intentionally left blank.**



# OPERATION

## A. Preliminary

Make sure the charger is installed and grounded as instructed in the INSTALLATION chapter of this manual.

Maintain electrolyte level in the batteries to be charged, as instructed by the battery manufacturer. Because the volume of electrolyte expands during the charging process, only add water when the battery is at least 80% charged. An amber light will be illuminated on the charger control panel when the battery is at or above 80% charge.

Insure the battery size matches the charger.

Battery number of cells must equal the number of cells stated on the charger data plate.

Battery ampere-hour capacity must be within the ampere-hour range stated on the charger data plate.

**WARNING: EXPLOSION HAZARD – Do not connect a battery to this charger if the “Charge in Progress” LED is illuminated on the charger. Do not disconnect a battery from this charger if the “Charge in Progress” LED is illuminated or ammeter is indicating charging current; otherwise, arcing and burning of connector parts can occur or a battery explosion may result. Batteries produce explosive gases. Keep sparks, flames, and cigarettes away. Ventilate when charging in an enclosed area. Always shield eyes using face shield and goggles when working near batteries.**

**CAUTION:** The charging of a battery with the incorrect number of cells or an ampere-hour capacity outside the range stated on the charger data plate will result in severe over or under charging of the battery, resulting in reduced battery performance and life.

## B. Normal or Daily Charge

**WARNING: DO NOT connect a battery to this charger if the “Charge in Progress” LED is lit. Do not disconnect a battery from this charger while a charge is in progress; otherwise, arcing and burning of connector parts or a battery explosion may result. Batteries produce explosive gases. Keep sparks, flame, and cigarettes away. Ventilate when charging in an enclosed area. Always shield eyes when working near batteries.**

1. Insure the battery size matches the charger (Battery voltage and ampere hour capacity are within nameplate information).
2. Securely engage the battery and charger connectors.
3. After a five second delay (all LED's will be lit), the charger will turn on. The “Charge in Progress” LED will indicate charging current.
4. The “80% CHARGED” LED will light when the battery on charge reaches the 80% charged voltage.
5. The charger will automatically turn off and the “Charge Complete” LED will light when the charge has finished. reaching 80% charge. The light will remain on until the battery is disconnected from the charger.

*NOTE: To disconnect battery from charger before charge is complete, first press the “Manual Stop” key, then disconnect the battery from the charger.*

## C. Equalize Or Weekend Charge

The Control features Auto Equalize on every 5th charge cycle. Closing S1-6 can disable the feature. When the Auto Equalize feature is disabled, an Equalize charge can be selected or de-selected for any charge cycle using the sequence below.

1. Insure the battery size matches the charger. (Number of cells and ampere-hour capacity are within charger nameplate rating.)
2. Securely engage the battery and charger connectors.
3. After a 5 second delay (all LED's will be lit), the charger will turn on. The "Charge in Progress" LED will indicate charging current.
4. Press the "EQUALIZE" key. The "Equalize" LED will light solid. Press the key again to cancel the equalize charge.

*NOTE: The equalize charge cannot be cancelled once the battery reaches the equalize charging period. Press the STOP key to terminate the charge.*

5. The "80% CHARGED" LED will light when the battery on charge reaches the 80% charged voltage.
6. The battery reaches the normal termination point. However, the battery is charged another 3 hours. The "Equalize" LED will flash during this equalize period.
7. The charger will automatically turn off, and the "Charge Complete" and the "Equalize" LED will light when the equalized charge has finished. The LEDs will remain on until the battery is disconnected from the charger.

**WARNING: DO NOT connect a battery to this charger if the "Charge in Progress" LED is lit. Do not disconnect a battery from this charger while a charge is in progress; otherwise, arcing and burning of connector parts or a battery explosion may result. Batteries produce explosive gases. Keep sparks, flame, and cigarettes away. Ventilate when charging in an enclosed area. Always shield eyes when working near batteries.**

## D. Manual Stop

1. To turn the charger OFF during any part of a charge cycle, press the STOP key. All four LEDs will flash.
2. To restart the charger, disconnect and reconnect the battery. A new charge cycle will begin.

## E. Refresh Charge

In order to guarantee that a fully charged battery is always ready for use, a "Refresh" feature has been incorporated into the Control. If a battery is left connected to the charger for 72 hours after a "Charge Complete" has been reached, the Control will start a charge sequence. The running time of this "Refresh" charge will depend on the depth of self-discharge of the battery.

## F. Back-up Timer Shutdown

A back-up timer will shut down the charger and all 4 LEDs will flash then the "Charge Complete" LED will flash if the battery on charge does not reach the 80% voltage during the first 10 hours of charging.

Likewise, if the charger does not reach the termination point within 5 hours after reaching the 80% charged voltage, all 4 LEDs will flash then the "Charge Complete" LED will flash.

## G. Battery Disconnect Shutdown

If the battery is disconnected from the charger during a charge cycle, the charger will be shut down. All LEDs will be off.

## H. AC Power Failure

During an AC power failure, the Control stores key information about the charge cycle. The information is retained by powering some of the control's key components with a battery derived power supply. This causes the control to resume the charge where it left off when the AC power is returned, unaffected timers and equalize requests.

# MAINTENANCE

**WARNING: ELECTRICAL SHOCK HAZARD** — Before inspecting or cleaning inside cabinet, turn OFF and remove fuses of disconnect switch (supplying AC power to charger), disconnect battery, and check for voltage on capacitors. Discharge through insulated screwdriver if there is any reading.

## Inspection And Cleaning

For uninterrupted, satisfactory service from this charger, it's necessary to keep unit clean, dry, and well ventilated. At least every three months, or more often as necessary, wipe and blow out all dirt from unit's interior components, with clean, dry air of not over 25 psi (172 kPa) pressure. Use a hand bellows if compressed air isn't available.

Check and tighten all electrical connections as necessary to eliminate unnecessary losses and to avoid subsequent trouble from overheating or open circuits. Check for broken wiring or damaged insulation on wiring.

**WARNING: ELECTRICAL SHOCK HAZARD** — Failure to keep internal parts clean and dry may allow transformer (s) to short out, causing secondary circuits to carry dangerously high voltage.

Be sure to replace all charger cabinet panels after any servicing, to assure proper flow of cooling air through unit and to protect internal components.

**WARNING: ELECTRICAL SHOCK HAZARD** — All cabinet panels must be replaced to protect personnel from contact with hazardous voltages.

## Lubrication

None required.

## Fuse Replacement

The silicon diodes in this charger are protected by a "fast-clearing" type fuse.

**CAUTION: The use of any other type fuse besides the "fast-clearing" type may cause damage to silicon diodes.**

## Silicon Diode Testing

**WARNING: ELECTRICAL SHOCK HAZARD** — Before checking electrical components, turn OFF and remove fuses of disconnect switch (supplying AC power to charger), disconnect battery, and check for voltage on capacitors. Discharge through insulated screwdriver if there is any reading.

1. Disconnect one diode lead to isolate diode from electrical circuitry.
2. Use a good quality ohmmeter (preferably one having a mid-scale value of approximately 50 ohms) to measure resistance values.
3. Zero ohmmeter on R x 1 scale.
4. Record indicated resistance while placing either ohmmeter lead on threaded end of diode and other ohmmeter lead on diode lead.
5. Reverse ohmmeter leads on diode and record indicated resistance.
6. Consider diode good if one resistance reading is infinitely (or very) high and the other is extremely low.

*NOTE: An acceptable low resistance value or range of values can't be given because of different readings from different ohmmeters, and differences in diodes of the same rating.*

## Capacitor Testing

1. Heed WARNING in Silicon Diode Testing section.
2. Disconnect capacitor and connect leads of ohmmeter (set to highest scale) to capacitor terminals.
3. If capacitor is good, pointer will deflect, indicating capacitor is being charged, followed by a deflection in the opposite direction indicating partial discharge.

If there is no deflection, capacitor is “open” and must be replaced. Also, if meter needle moves and stops at one value, replace capacitor.

Replacement capacitors must be ordered from factory. When ordering, supply serial number of charger and microfarad (MFD) or ( $\mu\text{F}$ ) value printed on capacitor.

# Troubleshooting

**DANGER: ELECTRICAL SHOCK HAZARD** — Before checking electrical components, turn OFF and remove fuses of disconnect switch (supplying AC power to charger), disconnect battery, and check for voltage on capacitors. Discharge through insulated screwdriver if there is any reading.

**CAUTION: HIGH VOLTAGE FROM TEST EQUIPMENT** can damage silicon diodes and other parts. Short silicon diodes with extremely short leads, or disconnect, before applying voltage from a "megger" or other high voltage test equipment.

The following chart contains information which can be used to diagnose and correct unsatisfactory operation or failure of various components of the unit. Each malfunction is followed by a suggested checking or inspection procedure. Refer to Connection/Schematic Diagram in the Diagrams chapter included in this manual.

## Troubleshooting Guide

### **No charging current (Ammeter reads zero)**

Check line voltage.

*Close fused disconnect switch or repair open circuit.*

Check for proper line voltage.

*Refer to Line Voltage Changeover instructions in Installation chapter.*

Check for blown fuses.

*Replace blown fuses. See Table 4-1 for proper fuse sizes.*

Check for internal short circuit (diode, winding, wiring).

*Repair short circuit, or replace faulty component.*

Check for "open" battery circuit.

*Clean and tighten connections, especially battery cable connections.*

Check Charge Control.

*Connect a jumper from the red-white lead of Control Transformer T1 to the red lead of Contactor K1 coil. If charger starts and ammeter shows charging current when a battery is connected, check further for faulty printed circuit card on control and replace as necessary.*

Check output circuit fuses. If fuse has blown, check for problem causing fuse to blow.

*a. Reverse battery connections, if polarity is wrong.*

*b. Determine whether a diode is shorted. Refer to Silicon Diode Testing in Maintenance chapter.*

**Low charging current at beginning of cycle (battery fully discharged)**

Check for failed capacitor (s) (one or more).

*Replace capacitor if can is ruptured or fails test. Refer to Capacitor Testing in Maintenance chapter.*

Check line voltage for connection to proper input voltage.

*Refer to Line Voltage Changeover instructions in Installation chapter.*

Check battery for one or more defective cells.

**Less than rated output on fully discharged battery (approximately 1/2 rated output) (3-phase chargers only)**

Check for either a shorted transformer, or wiring short circuit.

*Replace as necessary.*

**Charger does not shut OFF automatically or start automatically**

Check Charge Control.

1. If charger does not start automatically, check for 24 volts AC between the red-white lead and the red-black wire of control transformer T1. If 24V AC is present, connect a jumper from the red-white lead of control transformer T1 to the red lead of contactor K1 coil. If charger starts, check further for faulty printed circuit card on control and replace as necessary.
2. If charger does not stop automatically when equipped with pt/dv/dt control, check to be sure charging voltage rises above 2.37 volts/cell during the cycle. If not, see low charging current or less than rated output above. If battery on-charge voltage rises above 2.37 volts/cell during the cycle, check for defective control printed circuit card.

**DANGER: ELECTRICAL SHOCK HAZARD** — Before checking electrical components, turn OFF and remove fuses of disconnect switch (supply AC power to charger), disconnect battery, and check for voltage on capacitors. Discharge through insulated screwdriver if there is any reading.

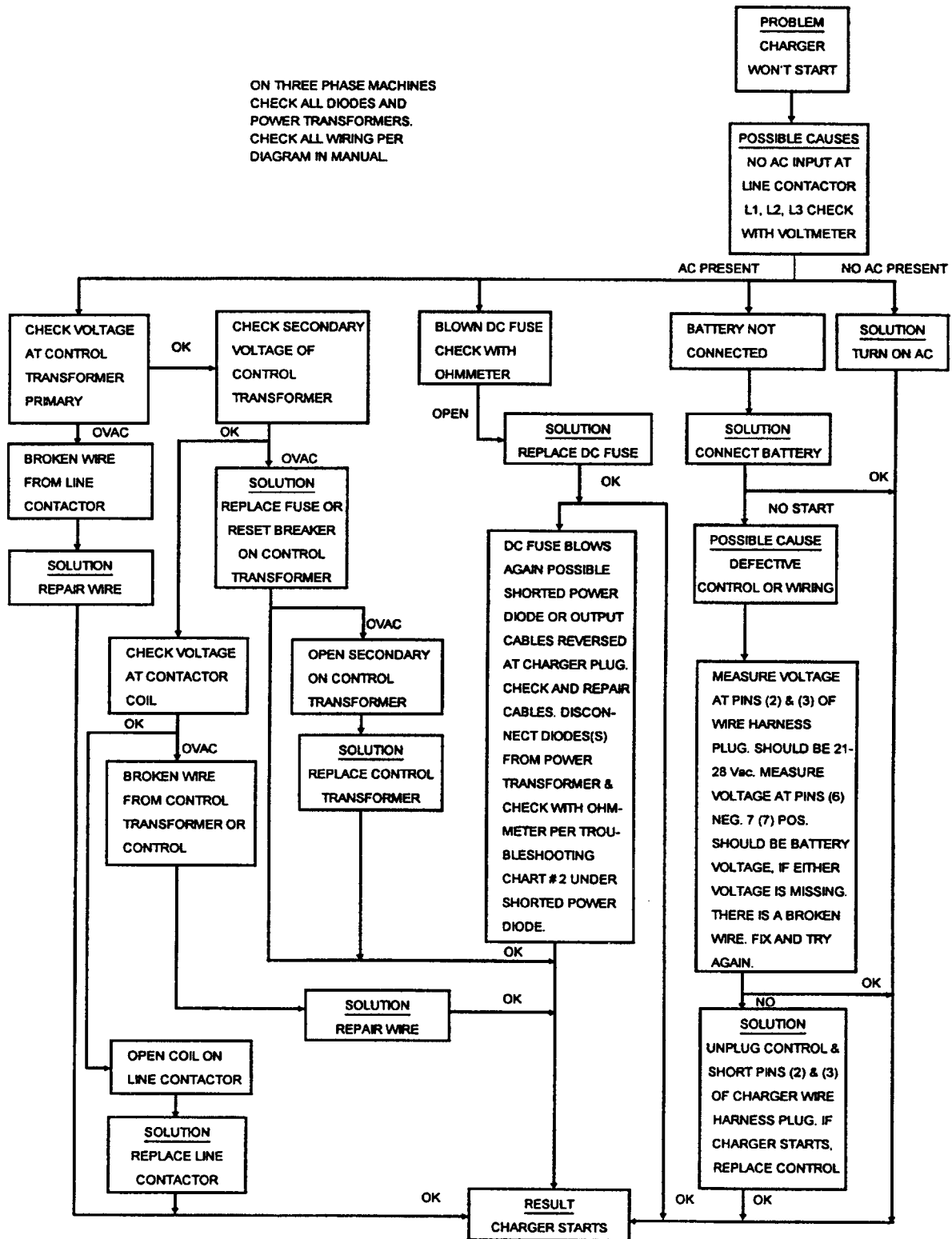

**DANGER: ELECTRICAL SHOCK HAZARD** — Before checking electrical components, turn OFF and remove fuses of disconnect switch (supply AC power to charger), disconnect battery, and check for voltage on capacitors. Discharge through insulated screwdriver if there is any reading.

ON THREE PHASE MACHINES  
 CHECK ALL DIODES AND AC  
 CAPACITORS. CHECK ALL  
 WIRING PER DIAGRAM IN  
 MANUAL.

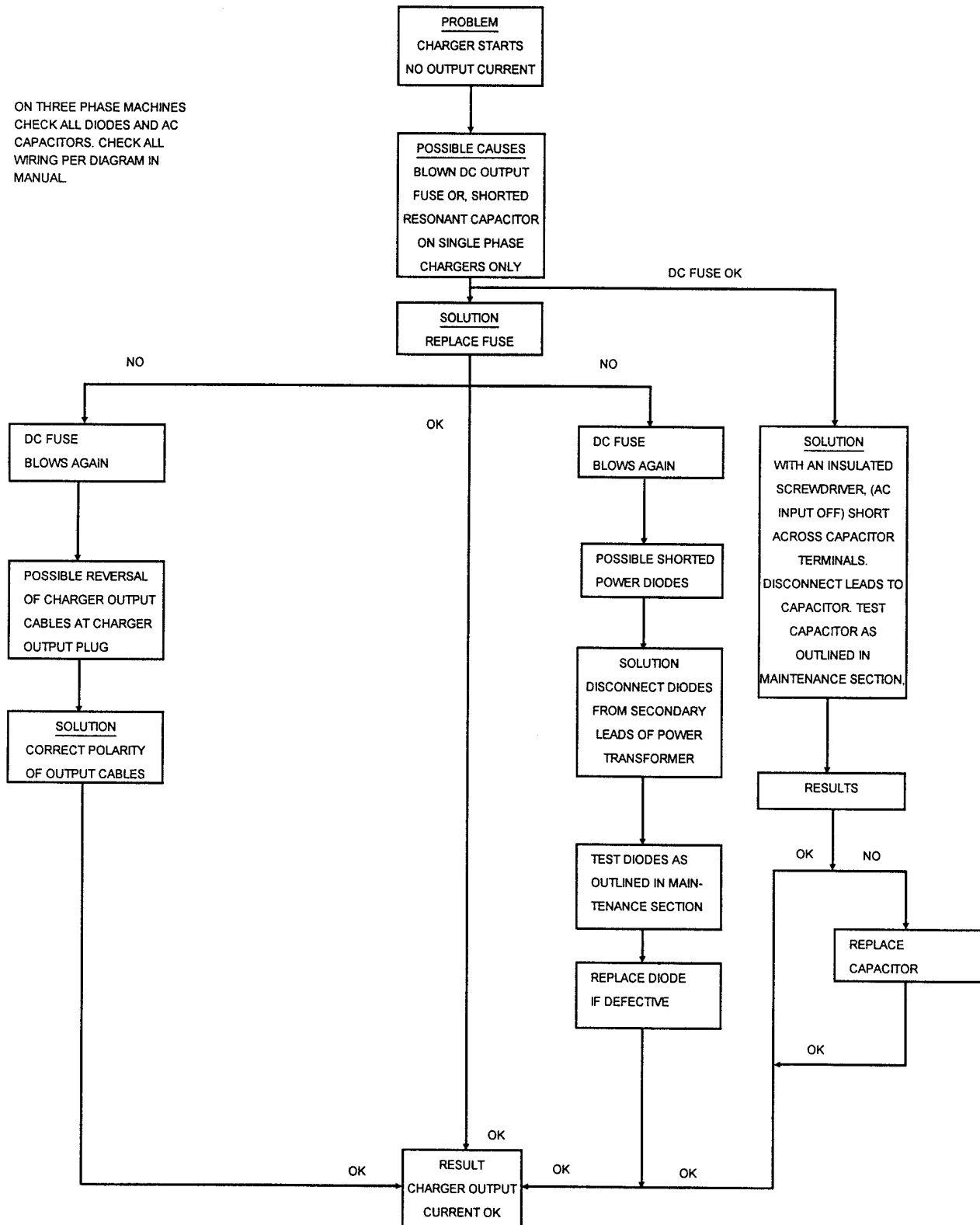



**DANGER: ELECTRICAL SHOCK HAZARD** — Before checking electrical components, turn OFF and remove fuses of disconnect switch (supply AC power to charger), disconnect battery, and check for voltage on capacitors. Discharge through insulated screwdriver if there is any reading.

**NOTE 1:**  
 ON THREE PHASE MACHINES, CHECK ALL DIODES AND CAPACITORS. CHECK ALL WIRING PER DIAGRAM IN MANUAL.

**NOTE 2:**  
 IF RESONANT CAPACITOR IS SHORTED ON SINGLE PHASE CHARGER, OUTPUT CURRENT WILL GO TO ZERO.

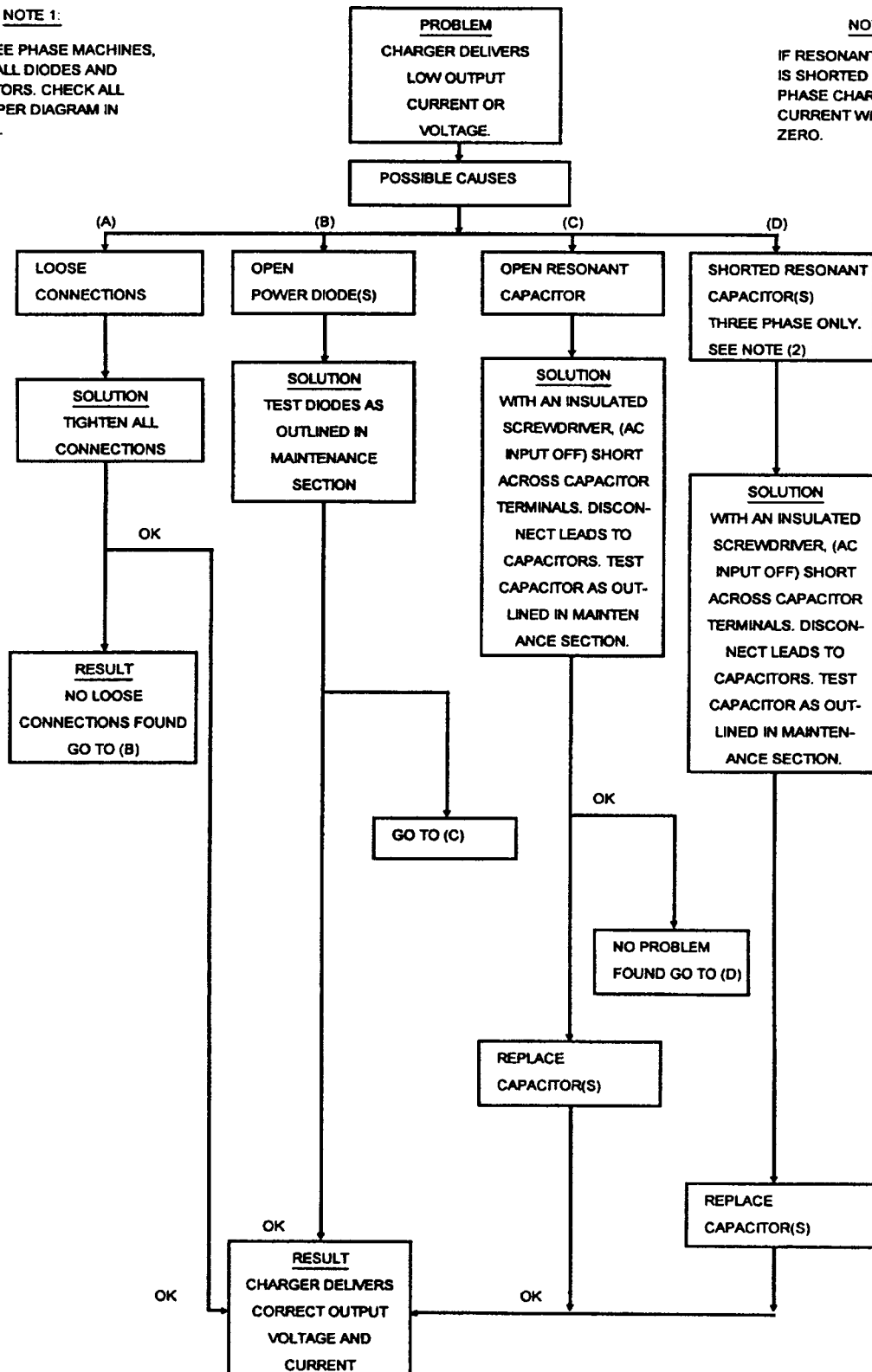

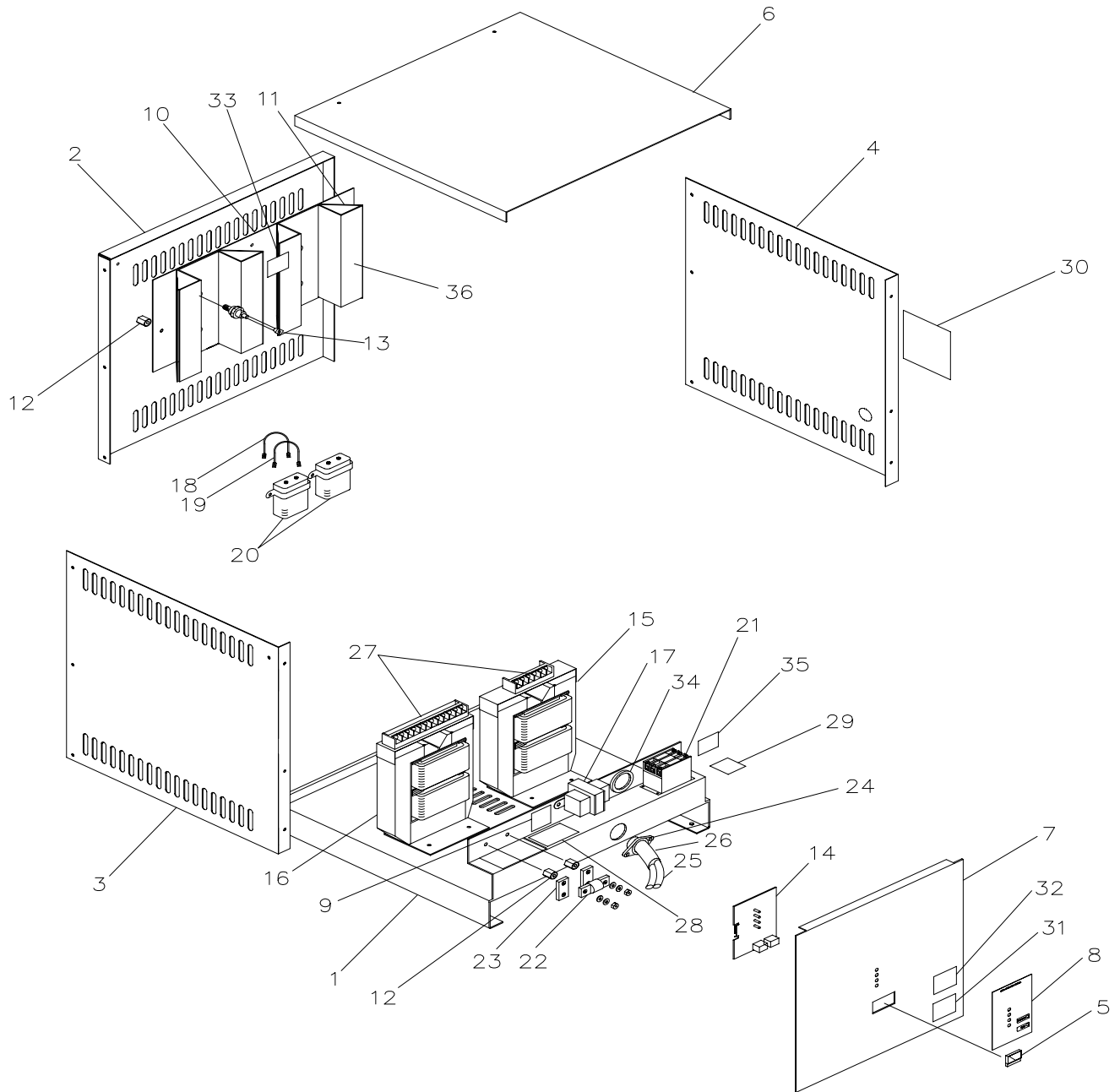

Figure 7-1 THREE PHASE

<u>ITEM NO.</u>	<u>PART NO.</u>	<u>DESCRIPTION</u>
1	195534	Base, Charger
2	195535	Panel, Rear
3	195537	Panel, Side, Left
4	195536	Panel, Side, Right
5	See Table	Meter, DC Amps
6	195538	Panel, Top
7	195539	Panel, Front
8	195251	Overlay, Charger
9	195531	Label, DC Output
10	191191	Heat Sink, Flat
11	191192	Heat Sink, Formed, 45 De- gree
12	404033	Insulator, Standoff
13	See Table	Diode, Silicon
14	195529-001	Control, Charger
15	See Table	Transformer, Power, Teaser
16	See Table	Transformer, Power, Main
17	See Table	Transformer, Control
18	357205-060	Jumper, Orange
19	357205-061	Jumper, White
20	See Table	Capacitor, Trans.
21	406243-001	Contactora, AC Input
22	See Table	Fuse, Output
23	392458	Bus Bar (2 Required)
24	W10080-005	Connector, Output Cable
25	See Table	Cable, Output
26	378234-013	Covering, Flex Cable

**193111-051  
PARTS LIST**

---

<b><u>ITEM NO.</u></b>	<b><u>PART NO.</u></b>	<b><u>DESCRIPTION</u></b>
27	Call Factory	Block, Terminal
28	406434	Label, Warning, Sparks
29	405548	Label, Supply Connections
30	See Table	Label, AC Input
31	404099	Label, Danger
32	195532	Label, Caution, Input Service
33	406518	Label, Warning
34	402037-027	Grommet, Rubber
35	406593	Label, Input Service
36	191193	Heat Sink, Formed, 90 Degree

3 PHASE

208/240/480 VOLT UNITS

MODEL NUMBER	COMPLETE SPEC	OUTPUT FUSE	DC METER	T2 TRANS	T3 TRANS	CAPS /TRANS	AC INPUT LABEL	CONTROL TRANS	OUTPUT CABLE
12-510FR60T	500580-1	409023-1	195540-1	195560	195561	TRY-154-4	191457	406247-2	396143-1
12-600FR60T	500581-1	409023-3	195540-1	195569	195570	TRY-154-4	191457	406247-2	396143-2
12-750FR60T	500582-1	409023-4	195540-2	195578	195579	TRY-154-4	191457	406247-2	396143-2
12-880FR60T	500583-1	409023-4	195540-2	195587	195588	TRY-154-6	191457	406247-2	396143-2
12-965FR60T	500584-1	409023-5	195540-2	195596	195597	TRY-154-6	191457	406247-2	396143-4
12-1050FR60T	500585-1	409023-5	195540-2	195605	195606	TRY-154-4 TRY-154-1	191457	406247-2	396143-4
12-1260FR60T	500586-1	409023-6	195540-2	195614	195615	TRY-154-4 TRY-154-1	191457	406247-2	396143-4
18-510FR60T	500587-1	409023-1	195540-1	195623	195624	TRY-154-4	191457	406247-2	396143-1
18-600FR60T	500588-1	409023-3	195540-1	195632	195633	TRY-154-4 TRY-154-2	191457	406247-2	396143-2
18-750FR60T	500589-1	409023-4	195540-2	195641	195642	TRY-154-6	191457	406247-2	396143-2
18-880FR60T	500590-1	409023-4	195540-2	195650	195651	TRY-154-6 TRY-154-1	191457	406247-2	396143-2
18-965FR60T	500591-1	409023-5	195540-2	195659	195660	TRY-154-6	191457	406247-2	396143-2
18-1050FR60T	500592-1	409023-5	195540-2	195668	195669	TRY-154-6	191457	406247-2	396143-4
18-1260FR60T	500593-1	409023-6	195540-2	195677	195678	TRY-154-6	191457	406247-2	396143-4
18-1400FR60T	500594-1	409023-7	195540-2	195686	195687	TRY-154-6	191457	406247-2	396143-5
24-750FR60T	500595-1	409023-4	195540-2	195695	195696	TRY-154-6	191457	406247-2	396143-2
24-880FR60T	500596-1	409023-4	195540-2	195704	195705	TRY-154-6 TRY-154-1	191457	406247-2	396143-2
24-965FR60T	500597-1	409023-5	195540-2	195713	195714	TRY-154-6 TRY-154-1	191457	406247-2	396143-4
24-1050FR60T	500598-1	409023-5	195540-2	195722	195723	TRY-154-6 TRY-154-1	191457	406247-2	396143-4
24-1260FR60T	500599-1	409023-6	195540-2	195731	195732	TRY-154-6	191457	406247-2	396143-4
40-600FR60T	500600-1	409023-3	195540-1	195740	195741	TRY-154-6	191457	406247-2	396143-2
40-750FR60T	500601-1	409023-4	195540-2	195749	195750	TRY-154-6	191457	406247-2	396143-2

**3 PHASE**  
**480/575 VOLT UNITS**

MODEL NUMBER	COMPLETE SPEC	OUTPUT FUSE	DC METER	T2 TRANS	T3 TRANS	CAPS /TRANS	AC INPUT LABEL	CONTROL TRANS	OUTPUT CABLE
12-510FR60T	500580-2	409023-1	195540-1	195564	195565	TRY-154-4	191252	406247-4	396143-1
12-600FR60T	500581-2	409023-3	195540-1	195573	195574	TRY-154-4	191252	406247-4	396143-2
12-750FR60T	500582-2	409023-4	195540-2	195582	195583	TRY-154-4	191252	406247-4	396143-2
12-880FR60T	500583-2	409023-4	195540-2	195591	195592	TRY-154-6	191252	406247-4	396143-2
12-965FR60T	500584-2	409023-5	195540-2	195600	195601	TRY-154-6	191252	406247-4	396143-4
12-1050FR60T	500585-2	409023-5	195540-2	195609	195610	TRY-154-4 TRY-154-1	191252	406247-4	396143-4
12-1260FR60T	500586-2	409023-6	195540-2	195618	195619	TRY-154-4 TRY-154-1	191252	406247-4	396143-4
18-510FR60T	500587-2	409023-1	195540-1	195627	195628	TRY-154-4	191252	406247-4	396143-2
18-600FR60T	500588-2	409023-3	195540-1	195636	195637	TRY-154-4 TRY-154-2	191252	406247-4	396143-2
18-750FR60T	500589-2	409023-4	195540-2	195645	195646	TRY-154-6	191252	406247-4	396143-2
18-880FR60T	500590-2	409023-4	195540-2	195654	195655	TRY-154-6 TRY-154-1	191252	406247-4	396143-2
18-965FR60T	500591-2	409023-5	195540-2	195663	195664	TRY-154-6	191252	406247-4	396143-4
18-1050FR60T	500592-2	409023-5	195540-2	195672	195673	TRY-154-6	191252	406247-4	396143-4
18-1260FR60T	500593-2	409023-6	195540-2	195681	195682	TRY-154-6	191252	406247-4	396143-4
18-1400FR60T	500594-2	409023-7	195540-2	195690	195691	TRY-154-6	191252	406247-4	396143-5
24-750FR60T	500595-2	409023-4	195540-2	195699	195700	TRY-154-6	191252	406247-4	396143-2
24-880FR60T	500596-2	409023-4	195540-2	195708	195709	TRY-154-6 TRY-154-1	191252	406247-4	396143-2
24-965FR60T	500597-2	409023-5	195540-2	195717	195718	TRY-154-6 TRY-154-1	191252	406247-4	396143-4
24-1050FR60T	500598-2	409023-5	195540-2	195726	195727	TRY-154-6 TRY-154-1	191252	406247-4	396143-4
24-1260FR60T	500599-2	409023-6	195540-2	195735	195736	TRY-154-6	191252	406247-4	396143-4
40-600FR60T	500600-2	409023-3	195540-1	195744	195745	TRY-154-6	191252	406247-2	396143-2
40-750FR60T	500601-2	409023-4	195540-2	195753	195754	TRY-154-6	191252	406247-2	396143-2

**This page intentionally left blank.**

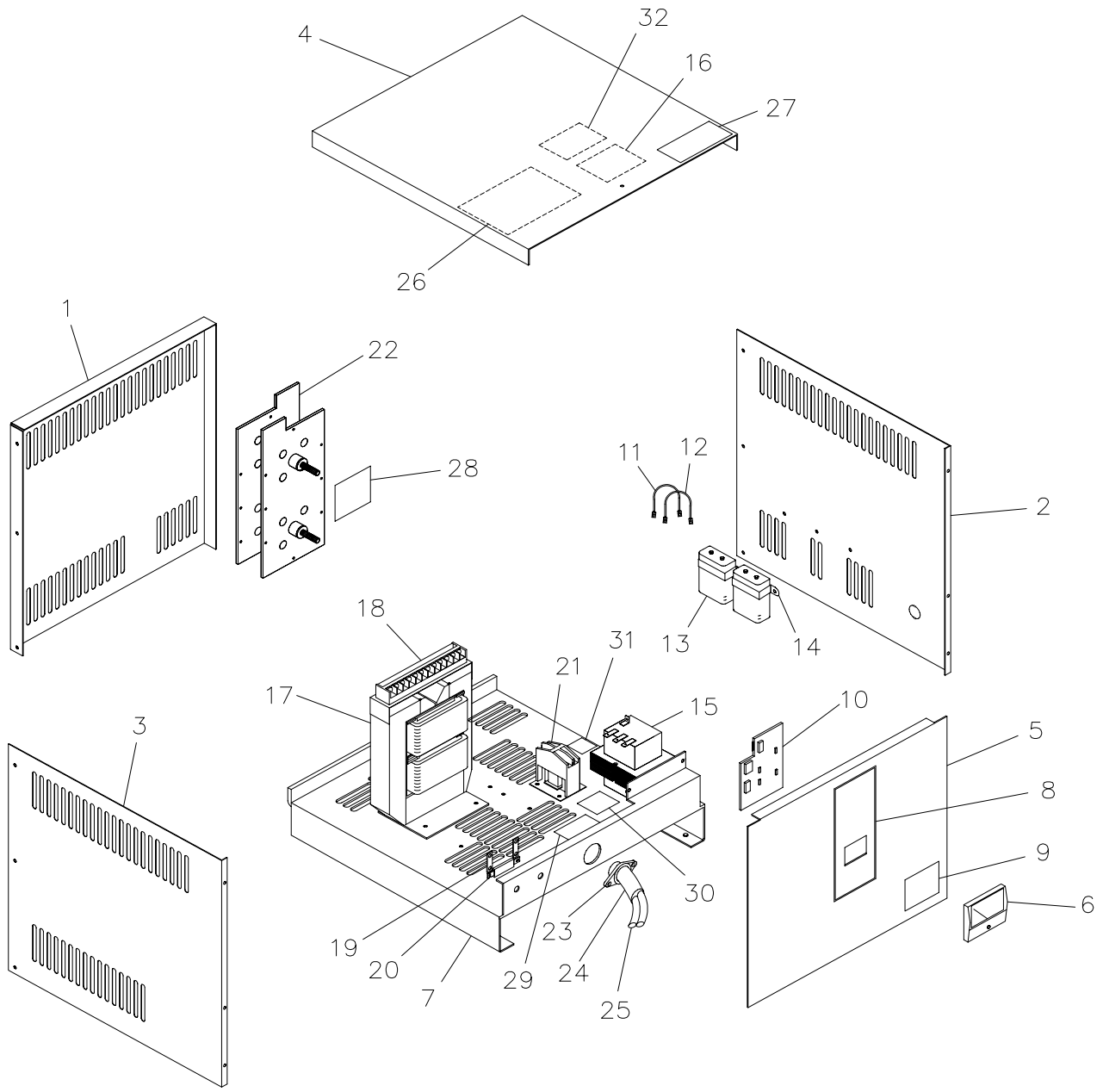

Figure 7-2 SINGLE PHASE



---

<u>ITEM NO.</u>	<u>PART NO.</u>	<u>DESCRIPTION</u>
1	191578	Panel, Rear
2	191580	Panel, Side, Right
3	191580	Panel, Side, Left
4	191581	Top
5	192983	Panel, Front
6	See Table	Meter DC Amps
7	191574	Base
8	195251	Overlay, Charger
9	195532	Label, Caution AC Input
10	195529-001	Board, PC, Ay
11	357205-060	Jumper, Orange (2 Required)
12	357205-061	Jumper, White (2 Required)
13	See Table	Capacitor, AC Oil
14	TRY174-003	Bracket, Capacitor
15	See Table	Transformer, Control
16	406434	Label, Warning, Input
17	See Table	Transformer, T2
18	Contact Factory	Terminal Block
19	392458	Bus Bar (2 Required)
20	See Table	Fuse, Output.
21	See Table	Contact, Line
22	See Table	Rectifier Ay
23	378234-013	Cover, Outer Neoprene
24	W10080-005	Connector, Strain Relief
25	See Table	Cable, Output
26	See Table	Label, AC Input

**193111-051  
PARTS LIST**

---

<u>ITEM NO.</u>	<u>PART NO.</u>	<u>DESCRIPTION</u>
27	404099	Label, Danger
28	406518	Label, Warning
29	195531	Label, DC Fuse
30	406593	Label, AC Input
31	405548	Label, Frame Ground
32	406748	Label, AC Line Connections,
120V		
33	195856	Harness, Wire (Not Shown)

**1 PHASE**  
**208/240/480 VOLT UNITS**

MODEL NUMBER	COMPLETE SPEC	OUTPUT FUSE	DC METER	RECTIFIER ASSY.	T2 TRANS	CAPS /TRANS	AC INPUT LABEL	CONTROL TRANS	OUTPUT CABLE
6-380FR60S	500602-1	409023-1	195540-1	194700	195757	TRY-154-4	406461	406247-2	396143-1
6-510FR60S	500603-1	409023-1	195540-1	194701	195762	TRY-154-4	406461	406247-2	396143-1
6-600FR60S	500604-1	409023-3	195540-1	194702	195767	TRY-154-4	406461	406247-2	396143-2
12-250FR60S	500605-1	409023-1	195540-1	194700	195772	TRY-154-4	406461	406247-2	396143-1
12-380FR60S	500606-1	409023-1	195540-1	194700	195777	TRY-154-4	406461	406247-2	396143-1
12-450FR60S	500607-1	409023-1	195540-1	194701	195782	TRY-154-4	406461	406247-2	396143-1
12-510FR60S	500608-1	409023-1	195540-1	194701	195787	TRY-154-6	406461	406247-2	396143-1
12-600FR60S	500609-1	409023-3	195540-1	194702	195792	TRY-154-6	406461	406247-2	396143-2
12-750FR60S	500610-1	409023-4	195540-2	194707	195797	TRY-154-6	406461	406247-2	396143-2
12-880FR60S	500611-1	409023-4	195540-2	194707	195802	TRY-154-6	406461	406247-2	396143-2
12-965FR60S	500612-1	409023-4	195540-2	194703	195807	TRY-154-6	406461	406247-2	396143-2
18-510FR60S	500613-1	409023-1	195540-1	194701	195812	TRY-154-4 TRY-154-2	406461	406247-2	396143-1
18-600FR60S	500614-1	409023-3	195540-1	194702	195817	TRY-154-6	406461	406247-2	396143-2
18-750FR60S	500615-1	409023-4	195540-2	194707	195822	TRY-154-6 TRY-154-1	406461	406247-2	396143-2
18-880FR60S	500616-1	409023-4	195540-2	194707	195827	TRY-154-6 TRY-154-2	406461	406247-2	396143-2
24-510FR60S	500617-1	409023-1	195540-1	194701	195832	TRY-154-6	406461	406247-2	396143-1
24-600FR60S	500618-1	409023-3	195540-1	194702	195837	TRY-154-6	406461	406247-2	396143-2
24-750FR60S	500619-1	409023-4	195540-2	194707	195842	TRY-154-6	406461	406247-2	396143-2

**1 PHASE**  
**480/575 VOLT UNITS**

MODEL NUMBER	COMPLETE SPEC	OUTPUT FUSE	DC METER	RECTIFIER ASSY.	T2 TRANS	CAPS /TRANS	AC INPUT LABEL	CONTROL TRANS	OUTPUT CABLE
6-510FR60S	500603-2	409023-1	195540-1	194701	195764	TRY-154-4	191655	406247-4	396143-1
6-600FR60S	500604-2	409023-3	195540-1	194702	195769	TRY-154-4	191655	406247-4	396143-2
12-250FR60S	500605-2	409023-1	195540-1	194700	195774	TRY-154-4	191655	406247-4	396143-1
12-380FR60S	500606-2	409023-1	195540-1	194700	195779	TRY-154-4	191655	406247-4	396143-1
12-450FR60S	500607-2	409023-1	195540-1	194701	195784	TRY-154-4	191655	406247-4	396143-1
12-510FR60S	500608-2	409023-1	195540-1	194701	195789	TRY-154-6	191655	406247-4	396143-1
12-600FR60S	500609-2	409023-3	195540-1	194702	195794	TRY-154-6	191655	406247-4	396143-2
12-750FR60S	500610-2	409023-4	195540-2	194707	195799	TRY-154-6	191655	406247-4	396143-2
12-880FR60S	500611-2	409023-4	195540-2	194707	195804	TRY-154-6	191655	406247-4	396143-2
12-965FR60S	500612-2	409023-4	195540-2	194703	195809	TRY-154-6	191655	406247-4	396143-2
18-510FR60S	500613-2	409023-1	195540-1	194701	195814	TRY-154-4 TRY-154-2	191655	406247-4	396143-1
18-600FR60S	500614-2	409023-3	195540-1	194702	195819	TRY-154-6	191655	406247-4	396143-2
18-750FR60S	500615-2	409023-4	195540-2	194707	195824	TRY-154-6 TRY-154-1	191655	406247-4	396143-2
18-880FR60S	500616-2	409023-4	195540-2	194707	195829	TRY-154-6 TRY-154-2	191655	406247-4	396143-2
24-510FR60S	500617-2	409023-1	195540-1	194701	195834	TRY-154-6	191655	406247-4	396143-1
24-600FR60S	500618-2	409023-3	195540-1	194702	195839	TRY-154-6	191655	406247-4	396143-2
24-750FR60S	500619-2	409023-4	195540-2	194707	195844	TRY-154-6	191655	406247-4	396143-2

1 PHASE  
120/208/240 VOLT UNITS

MODEL NUMBER	COMPLETE SPEC	OUTPUT FUSE	DC METER	RECTIFIER ASSY.	T2 TRANS	CAPS /TRANS	AC INPUT LABEL	CONTROL TRANS	OUTPUT CABLE
6-380FR60S	500602-5	409023-1	195540-1	195858-1	195757	TRY-154-4	406465	406247-1	396143-1
12-380FR60S	500606-5	409023-1	195540-1	195858-1	195759	TRY-154-4	406465	406247-1	366143-1

**This page intentionally left blank.**

# DIAGRAMS

MODEL NO. INFORMATION	DIAGRAM OUTPUT SCHEMATIC 208/240/480 VOLTS	DIAGRAM OUTPUT SCHEMATIC 480/575V	DIMENSIONAL OUTLINE
3 PHASE (2 TRANSFORMERS)	195432	195541	195542
See model number description inside front cover.			

MODEL NO. INFORMATION	DIAGRAM OUTPUT SCHEMATIC 208/240/480 VOLTS	DIAGRAM OUTPUT SCHEMATIC 480/575V	DIMENSIONAL OUTLINE
1 PHASE	195433	195860	195859
See model number description inside front cover.			

MODEL NO. INFORMATION	DIAGRAM OUTPUT SCHEMATIC 120/208/240 VOLTS	DIMENSIONAL OUTLINE
1 PHASE	195433	195859
See model number description inside front cover.		

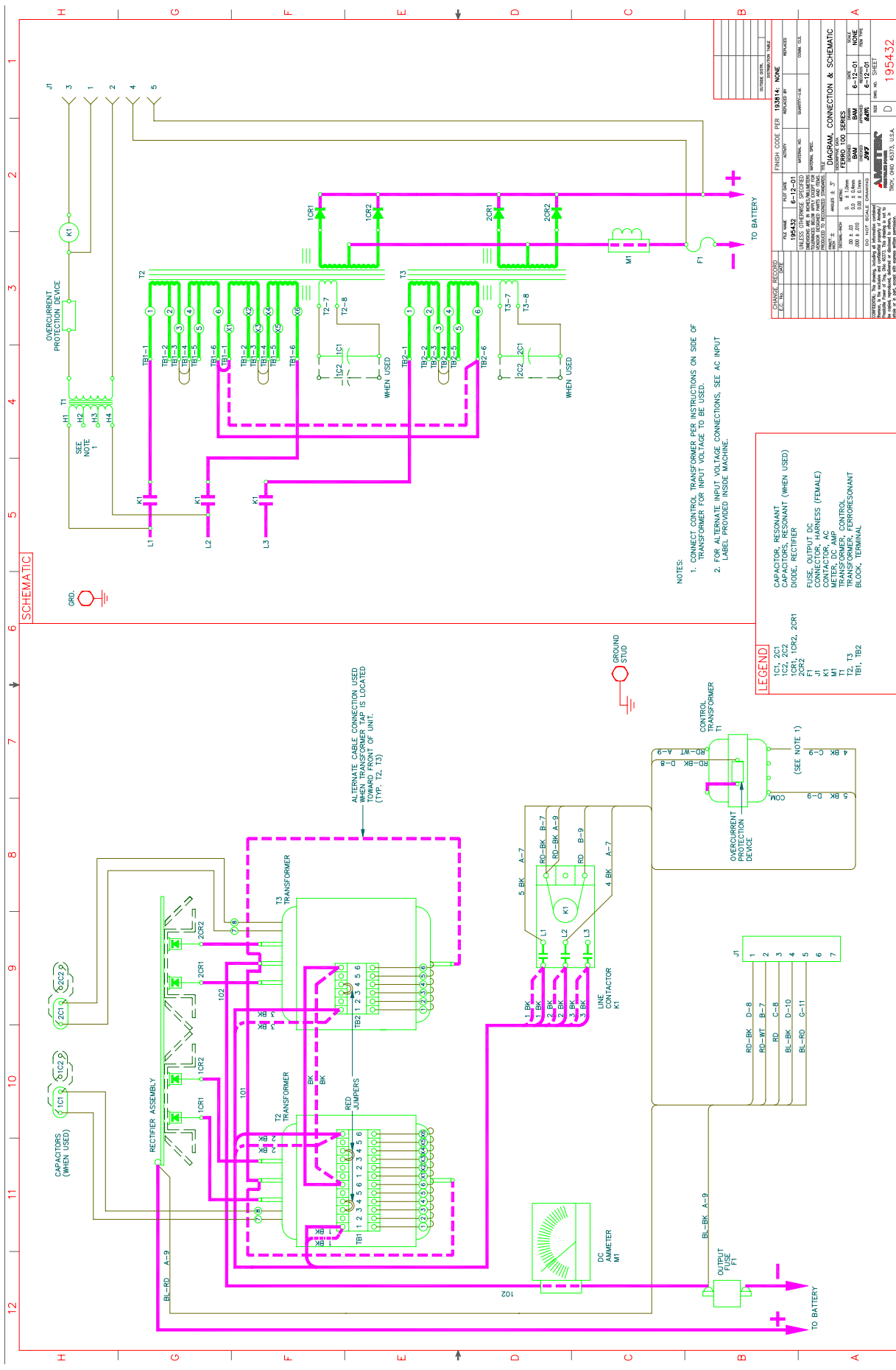



SCHEMATIC

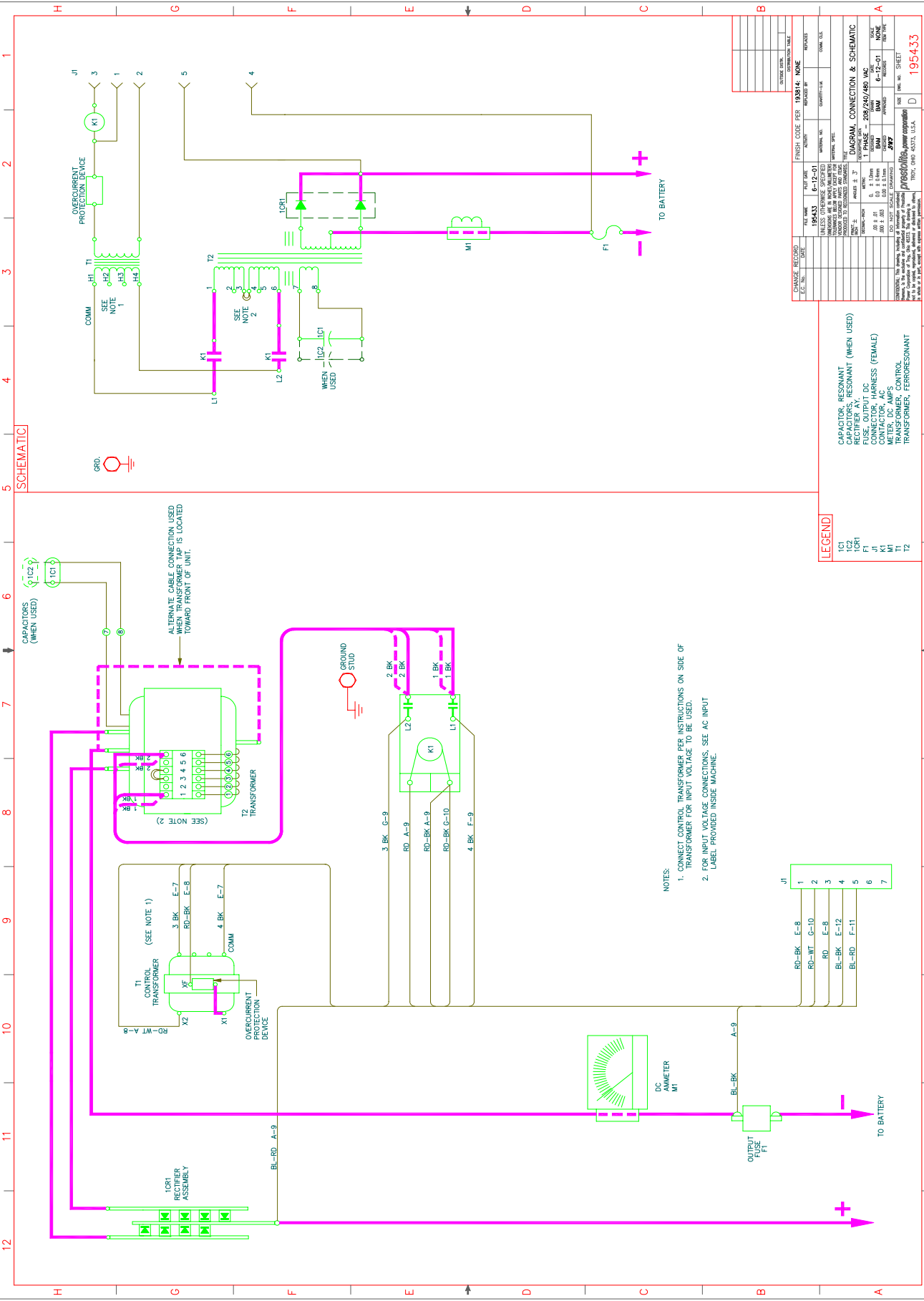

LEGEND

- 1CR1 1CR1 RECIFIER ASSEMBLY
- C1 CAPACITOR
- F1 FUSE
- M1 DC AMMETER
- T1 TRANSFORMER
- T2 TRANSFORMER

- NOTES:
1. CONNECT CONTROL TRANSFORMER PER INSTRUCTIONS ON SIDE OF TRANSFORMER FOR INPUT VOLTAGE TO BE USED.
  2. FOR INPUT VOLTAGE CONNECTIONS, SEE AC INPUT LABEL PROVIDED INSIDE MACHINE.



FILE NO.	DATE	DESCRIPTION
195433	8-12-01	REVISED PER 195433

FINISH CODE PER 195433	REVISION	DATE
NONE	1	8-12-01
	2	
	3	
	4	
	5	
	6	
	7	

DIAGRAM, CONNECTION & SCHEMATIC

PHASE - 208/240/480 VAC

APPROVED: [Signature]

DATE: 8-12-01

BY: [Signature]

SCALE: 1:1

FIG. NO. SHEET

195433

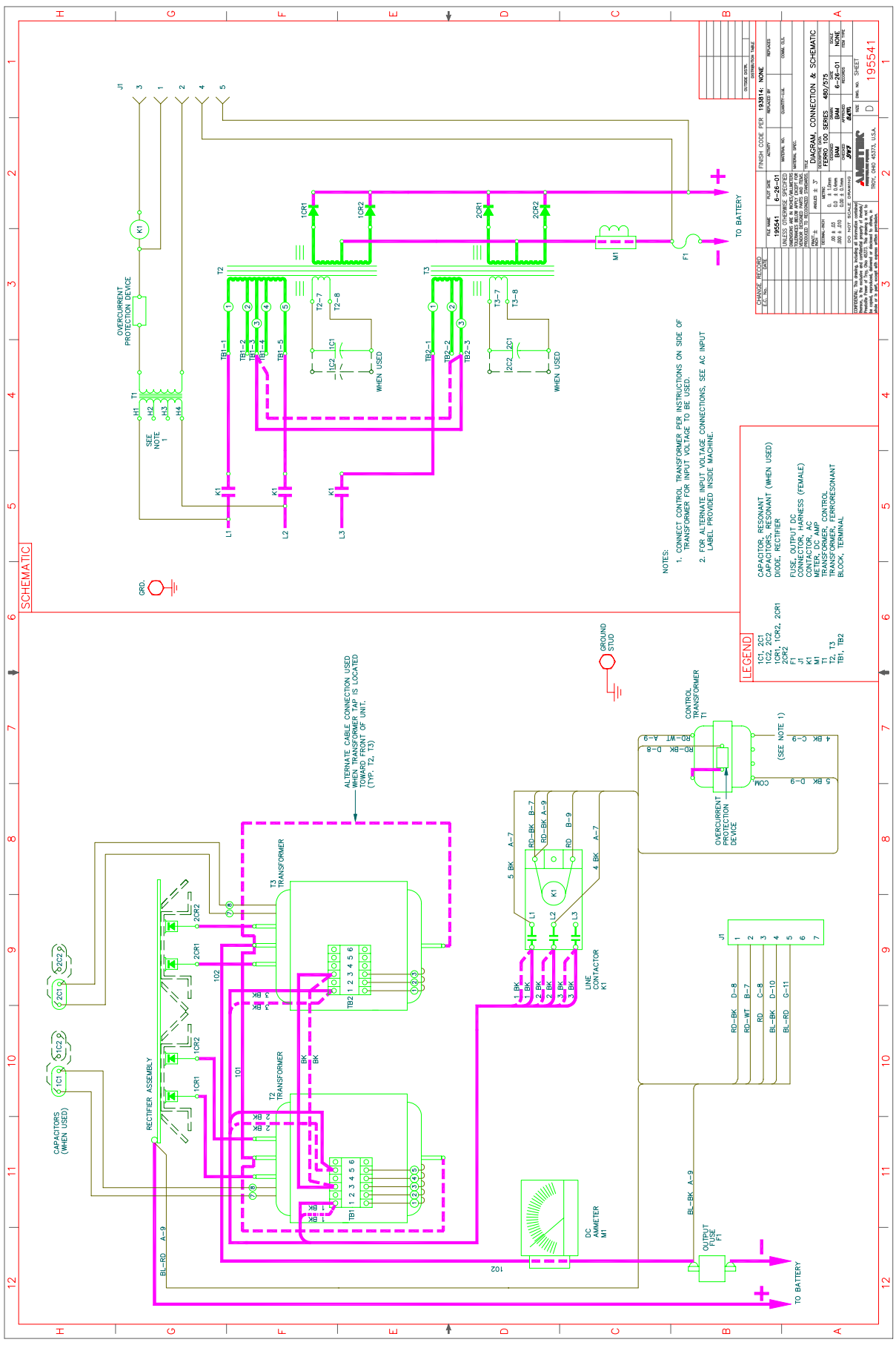

SCHEMATIC

REV.	DATE	DESCRIPTION

CHANGE RECORD	DATE	DESCRIPTION

FINISH CODE PER 183814	NONC	REWORKS

DATE	BY	DESCRIPTION

DIAGRAM CONNECTION & SCHEMATIC	480/975

REV.	DATE	DESCRIPTION

- NOTES:
1. CONNECT CONTROL TRANSFORMER PER INSTRUCTIONS ON SIDE OF TRANSFORMER FOR INPUT VOLTAGE TO BE USED.
  2. FOR ALTERNATE INPUT VOLTAGE CONNECTIONS, SEE AC INPUT LABEL PROVIDED INSIDE MACHINE.

- LEGEND
- 1C1, 1C2 CAPACITORS, RESONANT (WHEN USED)
  - 1C2, 2C2 DIODE, RECTIFIER
  - 2C1, 2C2 FUSE, OUTPUT DC
  - F1 FUSE, OVERCURRENT PROTECTION
  - M1 CONTACTOR, AC
  - M1 METER, DC AMP
  - T1 CONTROL TRANSFORMER
  - T2, T3 TRANSFORMER FERRORESONANT
  - TB1, TB2 BLOCK, TERMINAL

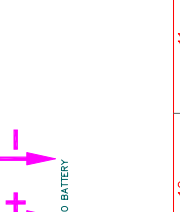
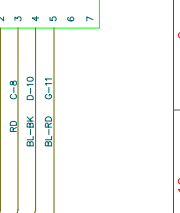
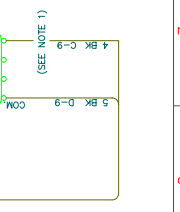

**SCHEMATIC**

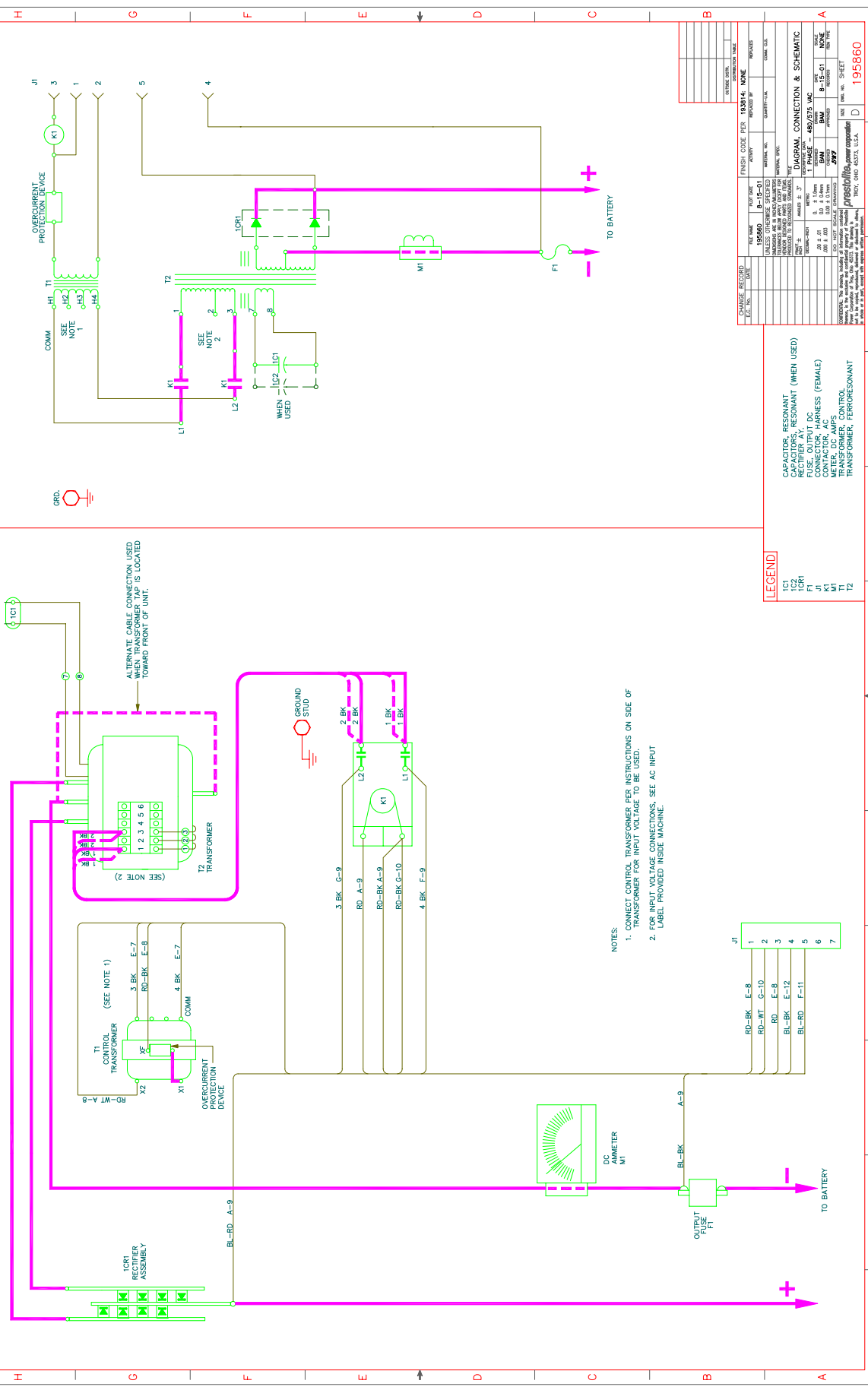

- NOTES:
1. CONNECT CONTROL TRANSFORMER PER INSTRUCTIONS ON SIDE OF TRANSFORMER FOR INPUT VOLTAGE TO BE USED.
  2. FOR INPUT VOLTAGE CONNECTIONS, SEE AC INPUT LABEL PROVIDED INSIDE MACHINE.

**LEGEND**

- 1C1 CAPACITOR, RESONANT (WHEN USED)
- 1C2 CAPACITOR, RESONANT (WHEN USED)
- F1 FUSE, OUTPUT DC
- J1 CONNECTOR, HARNESS (FEMALE)
- K1 CONTACT, INTERLOCK (FEMALE)
- M1 METER, DC AMP
- T1 TRANSFORMER, CONTROL
- T2 TRANSFORMER, FERGUSON/T

DATE	REVISION	DESCRIPTION
1958-01	1	ASSEMBLY

NO. IN QUANTITY	DESCRIPTION	FINISH CODE PER 1008B-14	RESISTOR VALUE
1	RESISTOR	8-15-01	NONE

NO. IN QUANTITY	DESCRIPTION	FINISH CODE PER 1008B-14	RESISTOR VALUE
1	RESISTOR	8-15-01	NONE

NO. IN QUANTITY	DESCRIPTION	FINISH CODE PER 1008B-14	RESISTOR VALUE
1	RESISTOR	8-15-01	NONE

NO. IN QUANTITY	DESCRIPTION	FINISH CODE PER 1008B-14	RESISTOR VALUE
1	RESISTOR	8-15-01	NONE

NO. IN QUANTITY	DESCRIPTION	FINISH CODE PER 1008B-14	RESISTOR VALUE
1	RESISTOR	8-15-01	NONE

NO. IN QUANTITY	DESCRIPTION	FINISH CODE PER 1008B-14	RESISTOR VALUE
1	RESISTOR	8-15-01	NONE

  

NO. IN QUANTITY	DESCRIPTION	FINISH CODE PER 1008B-14	RESISTOR VALUE
1	RESISTOR	8-15-01	NONE

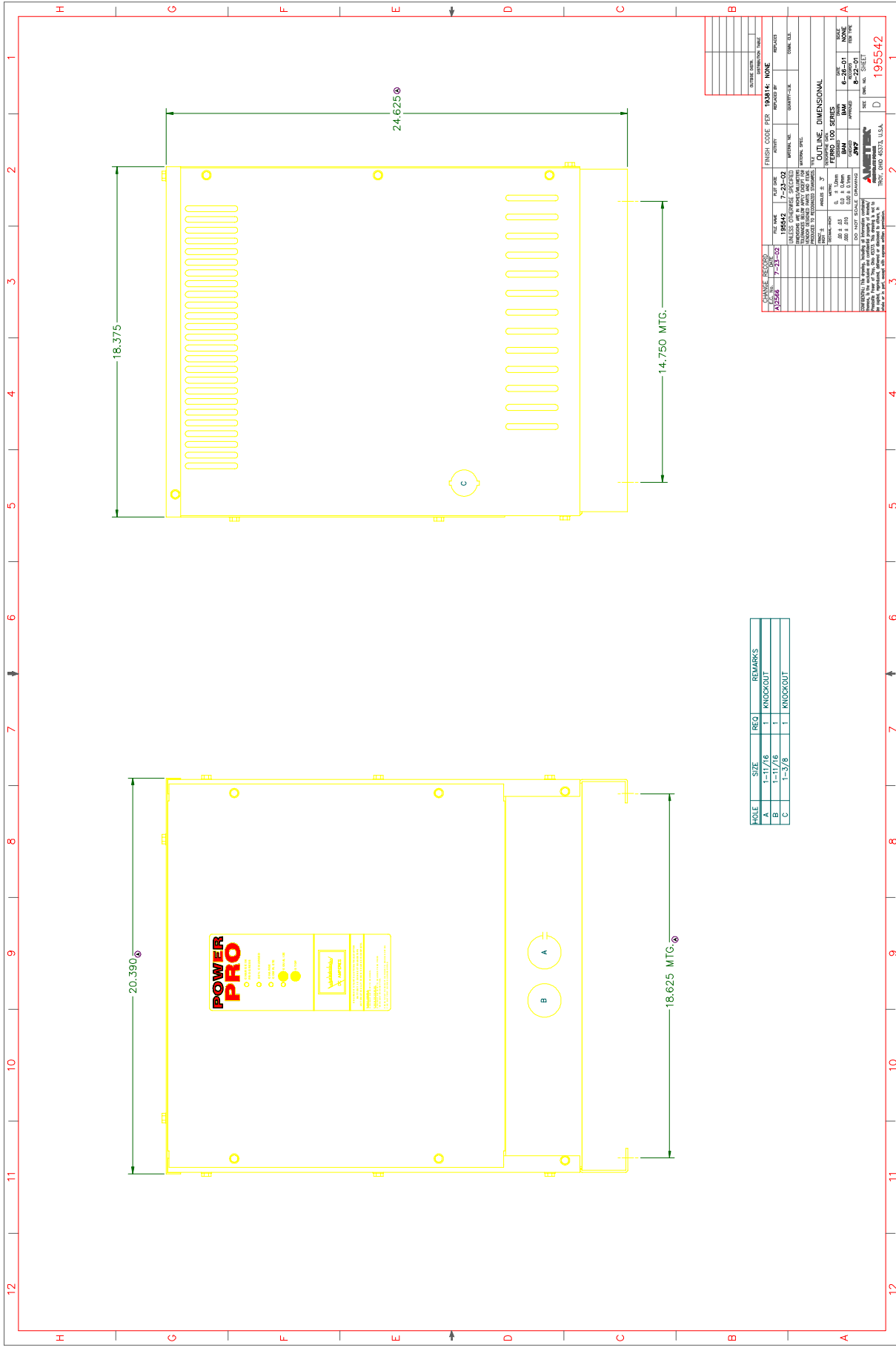

FILE	SIZE	REQ	REMARKS
A	1-11/8	1	KNOCKOUT
B	1-3/8	1	KNOCKOUT
C	1-3/8	1	KNOCKOUT

REVISED DESIGN	REV. NO.	REV. DATE	FINISH CODE PER	REVISION
25268	7-23-02	19542	19314	NONE
UNLESS OTHERWISE SPECIFIED				
MATERIALS SHALL BE AS SHOWN ON DRAWING				
DIMENSIONS ARE TO CENTER UNLESS OTHERWISE SPECIFIED				
TOLERANCES UNLESS OTHERWISE SPECIFIED				
FERRIS TOOL SERVICES				
1. MATERIAL				
2. DIMENSIONS				
3. FINISH				
4. COAT SYSTEM				
5. WEIGHT				
6. PRICE				
7. LEAD TIME				
8. COMMENTS				
9. OTHER				
10. DRAWING NO.				
11. SHEET NO.				
12. DATE				
13. DRAWN BY				
14. CHECKED BY				
15. APPROVED BY				
16. COMPANY				
17. ADDRESS				
18. PHONE				
19. FAX				
20. E-MAIL				
21. WEBSITE				
22. NOTES				
23. COMMENTS				
24. REVISIONS				
25. SCALE				
26. TYPING				
27. PRINTING				
28. FINISH				
29. COLOR				
30. OTHER				

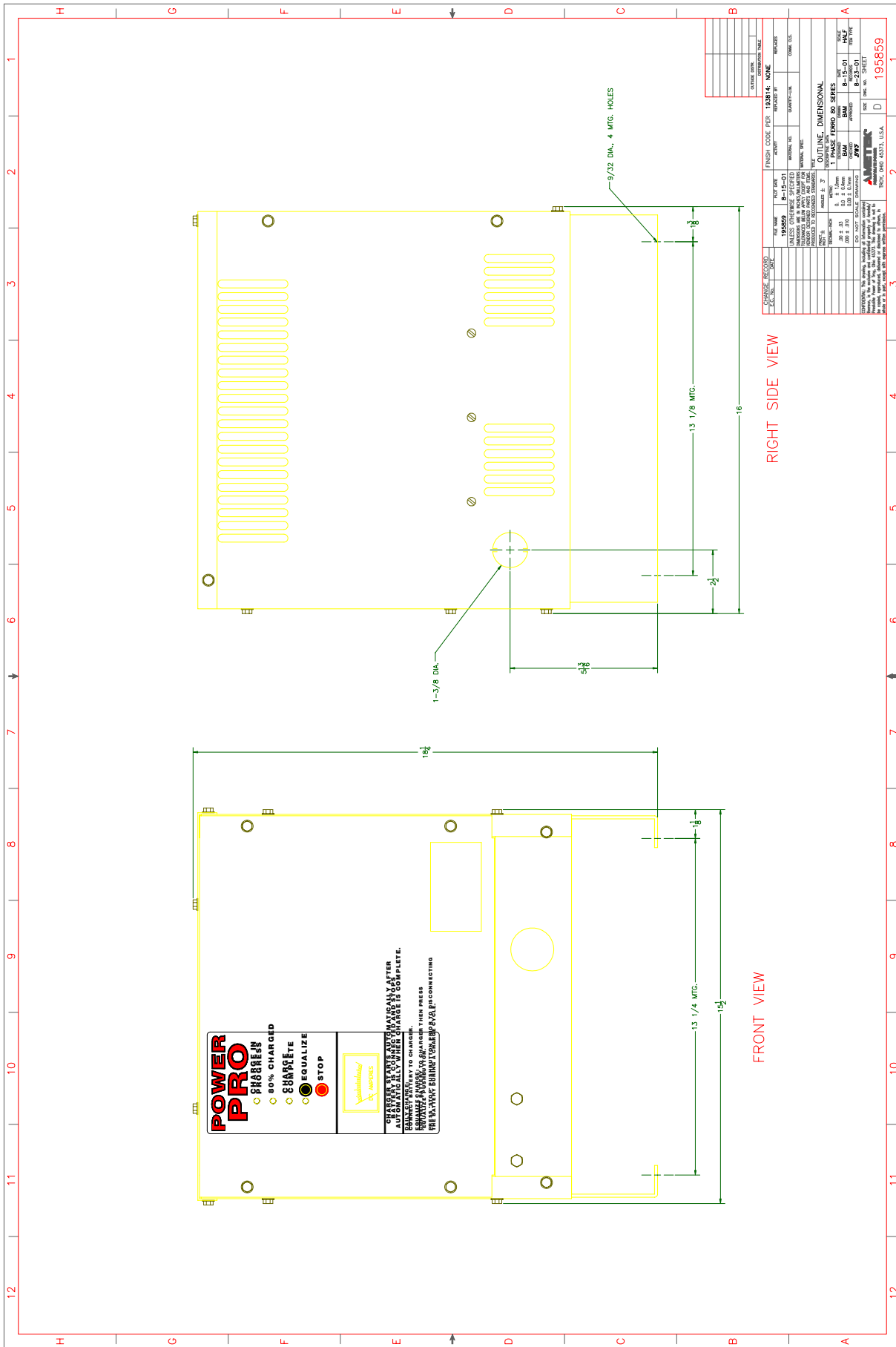

**POWER PRO**

80% CHARGED  
 CHARGE  
 COMPLETE  
 EQUALIZE  
 STOP



CHARGE BY PRESSING CHARGE/ANALYZE AFTER  
 AUTOMATICALLY WHEN CHARGE IS COMPLETE.  
 CONNECTION TO CHARGE.  
 RECHARGE BY PRESSING CHARGE/ANALYZE AFTER  
 THE BATTERY HAS BEEN FULLY CHARGED/CONNECTING

REVISE RECORD	FINISH CODE PER 192B14	NONE
DATE	REVISED BY	ISSUE
192B59	B-15-01	
UNLESS OTHERWISE SPECIFIED	MATERIAL NO.	QUANTITY
ENFORCE THE TOLERANCE AND SURFACE	FINISH	FORMING
PROCESSES TO BE USED	FINISH	FORMING
OUTLINE DIMENSIONAL		
ITEM	DESCRIPTION	QUANTITY
1	BATTERY PACK	1
2	1/4 IN DIA. 4 MTC. HOLES	4
3	1/8 IN DIA. 4 MTC. HOLES	4
4	1/4 IN DIA. 4 MTC. HOLES	4
5	1/8 IN DIA. 4 MTC. HOLES	4
6	1/4 IN DIA. 4 MTC. HOLES	4
7	1/8 IN DIA. 4 MTC. HOLES	4
8	1/4 IN DIA. 4 MTC. HOLES	4
9	1/8 IN DIA. 4 MTC. HOLES	4
10	1/4 IN DIA. 4 MTC. HOLES	4
11	1/8 IN DIA. 4 MTC. HOLES	4
12	1/4 IN DIA. 4 MTC. HOLES	4
13	1/8 IN DIA. 4 MTC. HOLES	4
14	1/4 IN DIA. 4 MTC. HOLES	4
15	1/8 IN DIA. 4 MTC. HOLES	4
16	1/4 IN DIA. 4 MTC. HOLES	4
17	1/8 IN DIA. 4 MTC. HOLES	4
18	1/4 IN DIA. 4 MTC. HOLES	4
19	1/8 IN DIA. 4 MTC. HOLES	4
20	1/4 IN DIA. 4 MTC. HOLES	4
21	1/8 IN DIA. 4 MTC. HOLES	4
22	1/4 IN DIA. 4 MTC. HOLES	4
23	1/8 IN DIA. 4 MTC. HOLES	4
24	1/4 IN DIA. 4 MTC. HOLES	4
25	1/8 IN DIA. 4 MTC. HOLES	4
26	1/4 IN DIA. 4 MTC. HOLES	4
27	1/8 IN DIA. 4 MTC. HOLES	4
28	1/4 IN DIA. 4 MTC. HOLES	4
29	1/8 IN DIA. 4 MTC. HOLES	4
30	1/4 IN DIA. 4 MTC. HOLES	4
31	1/8 IN DIA. 4 MTC. HOLES	4
32	1/4 IN DIA. 4 MTC. HOLES	4
33	1/8 IN DIA. 4 MTC. HOLES	4
34	1/4 IN DIA. 4 MTC. HOLES	4
35	1/8 IN DIA. 4 MTC. HOLES	4
36	1/4 IN DIA. 4 MTC. HOLES	4
37	1/8 IN DIA. 4 MTC. HOLES	4
38	1/4 IN DIA. 4 MTC. HOLES	4
39	1/8 IN DIA. 4 MTC. HOLES	4
40	1/4 IN DIA. 4 MTC. HOLES	4
41	1/8 IN DIA. 4 MTC. HOLES	4
42	1/4 IN DIA. 4 MTC. HOLES	4
43	1/8 IN DIA. 4 MTC. HOLES	4
44	1/4 IN DIA. 4 MTC. HOLES	4
45	1/8 IN DIA. 4 MTC. HOLES	4
46	1/4 IN DIA. 4 MTC. HOLES	4
47	1/8 IN DIA. 4 MTC. HOLES	4
48	1/4 IN DIA. 4 MTC. HOLES	4
49	1/8 IN DIA. 4 MTC. HOLES	4
50	1/4 IN DIA. 4 MTC. HOLES	4
51	1/8 IN DIA. 4 MTC. HOLES	4
52	1/4 IN DIA. 4 MTC. HOLES	4
53	1/8 IN DIA. 4 MTC. HOLES	4
54	1/4 IN DIA. 4 MTC. HOLES	4
55	1/8 IN DIA. 4 MTC. HOLES	4
56	1/4 IN DIA. 4 MTC. HOLES	4
57	1/8 IN DIA. 4 MTC. HOLES	4
58	1/4 IN DIA. 4 MTC. HOLES	4
59	1/8 IN DIA. 4 MTC. HOLES	4
60	1/4 IN DIA. 4 MTC. HOLES	4
61	1/8 IN DIA. 4 MTC. HOLES	4
62	1/4 IN DIA. 4 MTC. HOLES	4
63	1/8 IN DIA. 4 MTC. HOLES	4
64	1/4 IN DIA. 4 MTC. HOLES	4
65	1/8 IN DIA. 4 MTC. HOLES	4
66	1/4 IN DIA. 4 MTC. HOLES	4
67	1/8 IN DIA. 4 MTC. HOLES	4
68	1/4 IN DIA. 4 MTC. HOLES	4
69	1/8 IN DIA. 4 MTC. HOLES	4
70	1/4 IN DIA. 4 MTC. HOLES	4
71	1/8 IN DIA. 4 MTC. HOLES	4
72	1/4 IN DIA. 4 MTC. HOLES	4
73	1/8 IN DIA. 4 MTC. HOLES	4
74	1/4 IN DIA. 4 MTC. HOLES	4
75	1/8 IN DIA. 4 MTC. HOLES	4
76	1/4 IN DIA. 4 MTC. HOLES	4
77	1/8 IN DIA. 4 MTC. HOLES	4
78	1/4 IN DIA. 4 MTC. HOLES	4
79	1/8 IN DIA. 4 MTC. HOLES	4
80	1/4 IN DIA. 4 MTC. HOLES	4
81	1/8 IN DIA. 4 MTC. HOLES	4
82	1/4 IN DIA. 4 MTC. HOLES	4
83	1/8 IN DIA. 4 MTC. HOLES	4
84	1/4 IN DIA. 4 MTC. HOLES	4
85	1/8 IN DIA. 4 MTC. HOLES	4
86	1/4 IN DIA. 4 MTC. HOLES	4
87	1/8 IN DIA. 4 MTC. HOLES	4
88	1/4 IN DIA. 4 MTC. HOLES	4
89	1/8 IN DIA. 4 MTC. HOLES	4
90	1/4 IN DIA. 4 MTC. HOLES	4
91	1/8 IN DIA. 4 MTC. HOLES	4
92	1/4 IN DIA. 4 MTC. HOLES	4
93	1/8 IN DIA. 4 MTC. HOLES	4
94	1/4 IN DIA. 4 MTC. HOLES	4
95	1/8 IN DIA. 4 MTC. HOLES	4
96	1/4 IN DIA. 4 MTC. HOLES	4
97	1/8 IN DIA. 4 MTC. HOLES	4
98	1/4 IN DIA. 4 MTC. HOLES	4
99	1/8 IN DIA. 4 MTC. HOLES	4
100	1/4 IN DIA. 4 MTC. HOLES	4

1955859  
 D  
 1955859



# WARRANTY

## AMETEK/PRESTOLITE POWER "POWER PRO" BATTERY CHARGERS

AMETEK/Prestolite Power (hereinafter called "Prestolite") warrants that each new and unused Power Pro Battery Charger manufactured and supplied by it is of good workmanship and is free from any inherent mechanical defects, provided that (1) the product is installed and operated in accordance with generally accepted industrial standards and in accordance with the printed instructions of Prestolite, (2) the product is used under normal conditions for which designed, (3) the product is not subjected to misuse, negligence or accident, and (4) the product receives proper care, protection and maintenance under supervision of competent personnel. This warranty is subject to the following provisions:

**1.PRODUCTS AND PARTS WARRANTED.** Subject to the exceptions listed below each Power Pro Battery Charger is warranted for a period of one (1) year from the date of its shipment by Prestolite, provided the charger is used in accordance with Prestolite's published performance rating for the unit involved. The exceptions to this warranty are as follows:

- a) Power transformers and diodes on unit(s) are warranted for ten (10) years after Prestolite's shipment of the unit(s) of which they are a part, provided, however, that during the last nine (9) years of this ten (10) year period the warranty covers parts replacement only-no labor or other services are provided by Prestolite, nor shall Prestolite be obligated to reimburse the owner or any other person for any work performed.
- b) Primary switch contacts, fuses, bulbs, and filters are not warranted unless found to be defective prior to use.

**2.COMMENCEMENT OF WARRANTY TIME PERIODS.** The warranty periods indicated in the Warranty Schedule shall commence on the date of shipment by Prestolite.

**3.PERSONS COVERED BY WARRANTY.** This warranty is extended by Prestolite only to the purchaser of new equipment from Prestolite or one of its authorized distributors. The products purchased under this agreement shall be used exclusively by the buyer and its employees and by no other persons, and therefore there shall be no third party beneficiary to this warranty.

**4.LIMITATION OF REMEDY.** The existence of claimed defects in any product covered by this warranty is subject to Prestolite's factory inspection and judgment. Prestolite's liability is limited to repair of any defects found by Prestolite to exist or, at Prestolite's option, the replacement of the defective product. F.O.B. factory after the defective product has been returned by the purchaser at its expense to Prestolite's shipping place. Replacement parts will be warranted for the remainder of the original Power Pro Battery Charger Warranty or for a period of ninety (90) days, whichever is greater.

PRESTOLITE and its authorized distributors or dealers shall not be liable for direct or indirect, special or consequential damages in excess of such repair or replacement. In no event shall the purchaser be entitled to recover for contingent expenses resulting from, but not limited to, telephone calls, telegrams, travel expenses, lodging, duties and taxes, labor, rental or replacement equipment, loss of business or profits or other commercial losses.

**5.USE OF DEFECTIVE PRODUCT.** Continued use of a Power Pro Battery Charger after discovery of a defect VOIDS ALL WARRANTIES.

**6.ALTERED EQUIPMENT.** Except as authorized in writing, the warranty specified does not cover any equipment that has been altered by any party other than Prestolite.

EXCEPT AS STATED ABOVE, ALL OTHER WARRANTIES AND CONDITIONS, EITHER EXPRESSED OR IMPLIED, INCLUDING IMPLIED WARRANTIES OF MERCHANTABILITY AND FITNESS FOR A PARTICULAR PURPOSE, ARE EXCLUDED AND BUYER ASSUMES ALL RISK AND LIABILITY RESULTING FROM USE OF THE GOODS. AMETEK/PRESTOLITE POWER NEITHER ASSUMES NOR AUTHORIZES ANY PERSONS TO ASSUME FOR AMETEK/PRESTOLITE POWER ANY OTHER LIABILITY IN CONNECTION WITH THE SALE OR USE OF THE GOODS SOLD, AND THERE ARE NO ORAL AGREEMENTS OR WARRANTIES COLLATERAL TO OR AFFECTING THIS WRITTEN WARRANTY.

### WARNING

At all times, safety must be considered an important factor in the installation, servicing, and operation of the product, and skilled, qualified technical assistance should be utilized.

**AMETEK/PRESTOLITE POWER  
TROY, OHIO, U.S.A.**

Data Sheet: 1150  
Index: 080102  
Replaces: Original

