



# **User Manual**

## **EquaLink Battery Management System**

### **Copyright Statement for Intellectual Property and Confidential Information**

The information contained in this manual is non-conditional and may be changed without due notice. Although Storage Battery Systems LLC (SBS) has attempted to provide accurate information within this document, SBS assumes no responsibility for the accuracy of this information.

Storage Battery Systems shall not be liable for any indirect, special, consequential, or accidental damage including, without limitations, lost profits or revenues, costs of replacement goods, loss or damage to data arising out of the use of this document

The manufacturer of the EquaLink/BACS products undertakes no obligations with this information. The products that are described in this brochure are given on the sole basis of information to its channel partners for them to have a better understanding of the Generex products.

It is agreed that all rights, title and interest in the Generex's trademarks or trade names (whether or not registered) or goodwill from time to time of Generex or in any intellectual property right including without limitation any copyright, patents relating to the Products, shall remain the exclusive property of Generex.

## General Safety Precautions - Working with Batteries



Danger!

Improper use of the products described in this manual may lead to personal injury and/or property damage. STORAGE BATTERY SYSTEMS is not liable for injuries or damages that result from the improper handling of these products.



Risks associated with improper use include: explosion, fire, and short circuits. **Attention!** Battery terminals are always live, so never place metal objects or tools on top of the batteries.

Battery electrolyte solutions are highly corrosive. Should you observe leaks of electrolyte from a battery, be aware that these fluids are harmful to both eyes and skin.



Danger!

Installation, maintenance, and repair of batteries and battery equipment should be performed only by trained specialists (or personnel authorized by battery manufacturers to perform such services). Persons who have not been trained in battery safety or the proper handling of batteries (or who have not been authorized to work on them) must not handle batteries.

**Observe the following regulations (IEEE standards USA only):**

- ZVEI publication "Instructions for the Safe Handling of Electrolyte for Lead-acid Batteries."
- ZVEI publication "Safety Data Sheet on Battery Acid (Diluted Sulfuric Acid)."
- VDE 0510 Part 2: 2001-12, in accordance with EN 50272-2:2001: "Safety Requirements for Secondary Batteries and Battery Installations - Part 2: Stationary Batteries".
- IEEE Standard 450-2002: "Recommended Practice for Maintenance, Testing and Replacement of Vented Lead Acid Batteries for Stationary Application."
- IEEE Standard 1375-1998: "Guide for Protection of Stationary Battery Systems"



Attention!

Observe also the following safety rules:









1. **Ensure that all electrical loads and power supplies/charging devices (including separators, fuses, and switches) are switched off. This must be carried out by qualified personnel.**
2. Remove all wrist watches, rings, chains, jewelry and other metal objects before working with batteries.
3. Use insulated tools only.
4. Wear insulating rubber gloves and rubber shoes.
5. Never place tools or metal components on top of the batteries.
6. Make sure that the battery or batteries are not mistakenly grounded. (The consequences of an accidental or incorrect connection can be mitigated reduced by terminating the ground connection.) If the system is grounded, terminate the connection. **Touching a grounded battery by mistake can result in severe electric shock.**
7. Before establishing connections, make sure to verify polarity. (Better one too many times than one too few.)
8. Filled lead-acid batteries contain highly explosive gas (hydrogen/air mixture). **Never smoke, handle open flames or create sparks near the batteries.** Always avoid electrostatic discharge; wear cotton clothing and ground yourself if necessary.
9. Wear the appropriate safety clothing and equipment.



Attention!

For further information refer to the battery maker's instructions for installation, maintenance, and operation of their battery products.

## Safety – EQUALINK Safety Precautions

	 <b>ATTENTION</b>	
	<u>HIGH VOLTAGE WARNING</u>	<p>Do not open the EQUALINK sensor modules. Do not attach any kind of objects to the battery or the EQUALINK modules itself apart from the connecting cables! <b>The EQUALINK modules and cables could be live!</b></p>
 Attention!	<u>MAGNETIC EMISSIONS</u>	<p>Do not put any materials or equipment sensitive to magnetic emissions near the EQUALINK WEBMANAGER (For example, monitors, disk drives, memory chips or magnetic tapes.)</p>
 Attention!	<u>INSTALLATION BY QUALIFIED PERSONNEL ONLY!</u>	<p>The EQUALINK installation should only be installed by qualified personnel. EQUALINK is installed on batteries where high voltages could cause injuries or even death if not handled properly!</p>
 Danger!	<u>WARNING!</u>	<p>The EQUALINK connection cables (temperature cable, bus cable, measuring cable) could be live! To avoid short circuits, do not touch, replace, or cut EQUALINK cables, before having disconnected the system from the batteries!</p>
 Attention!	<u>CHECK MODULES DURING INSTALLATION AND INITIAL CHARGING</u>	<p>EQUALINK modules must NOT be mounted on a damaged battery! If a battery is damaged and its internal resistance is high, charging current (or current being discharged) may follow the path of least resistance and flow through the EQUALINK module, not the battery. Overheating and destruction of the EQUALINK module can result from this. For this reason, never use batteries that are damaged or show high internal resistances.</p>
 Danger!	<u>Observe battery temperature for up to 12 hours after a discharge period</u>	<p>The STORAGE BATTERY SYSTEMS service technician should monitor the EQUALINK modules and the initial charge during the installation. Excessive heat created by the EQUALINK may be indication of a damaged battery or incorrectly mounted cables. The installer should not leave the installation site before installation of the EQUALINK system is complete and the battery has had 60 minutes to charge. Once this has taken place, if the EQUALINK system shows stable voltages and normal internal resistance values, it may be considered safe and can be monitored remotely.</p> <p>Observe battery temperature for up to 12 hours after a discharge period! For VRLA batteries, the risk of thermal run-away is greatly elevated during the 12 hours following discharge. Rising temperatures in damaged battery cells and blocs can cause fire. React immediately if battery cell or bloc temperatures rise after a discharge phase.</p>

## Safety – EQUALINK Configuration and Installation

### AVOID INSTALLATIONS IN CERTAIN AREAS

Do **not** install EQUALINK in the following areas:

- Wet or dusty places, or rooms that are not protected from water or high humidity;
- Areas with a constantly high concentration of salted or oxidizing gases;
- Areas close to sources of extreme heat, open flames, or sparks, or having high variations in temperature;
- Areas prone to physical vibrations;
- Areas with high gas concentration or flammable materials.

### MONITORING SYSTEM - MONITORING AND ALARMS

EQUALINK is a monitoring system and should be used accordingly. Ensure proper setting of the alarm threshold and proper time frame for reaction to alarms!

- EQUALINK is a tool designed to increase the durability of batteries, but its most important function is to monitor the battery in order to avoid breakdowns. For this reason, it is recommended that situations that trigger alarms be attended to within two hours of alarm notification. EQUALINK may not be able to eliminate altogether the risk of battery or charger failures, but through its advance warning system and patented Equalization process, it gives the user the ability to prevent the issues that can result from such failures.
- **Never mix and match different EQUALINK C Module versions or EQUALINK Measuring cable types!** (For example: using EQUALINK C Modules with REV 2 and 3 on the same battery system, using EQUALINK BC2 and BC5 cables in the same battery system.) This practice can damage modules and lead to inaccurate measurements.

For questions and comments refer to: <http://www.SBSBattery.com> or [Test@SBSBattery.com](mailto:Test@SBSBattery.com)

# User Manual EQUALINK WEBMANAGER

## Contents

<a href="#"><u>Safety Precautions</u></a>	<b>1</b>
<a href="#"><u>Battery Management with EQUALINK</u></a>	<b>6</b>
<a href="#"><u>General Information</u></a>	<b>6</b>
<a href="#"><u>EQUALINK Components</u></a>	<b>7</b>
<a href="#"><u>EQUALINK Battery C-Modules</u></a>	7
<a href="#"><u>EQUALINK Measuring Cables</u></a>	8
<a href="#"><u>EQUALINK Bus Cables</u></a>	8
<a href="#"><u>EQUALINK WEBMANAGER Kit</u></a>	8
<a href="#"><u>EQUALINK RAS WEBMANAGER</u></a>	9
<b>1. <a href="#"><u>Quickstart - Installation of the EQUALINK Hardware</u></a></b>	<b>10</b>
<a href="#"><u>1.1 Installation of EQUALINK Cables, Module, Converter &amp; Splittbox</u></a>	10
<a href="#"><u>1.1.1 Assemble the EQUALINK Measuring Cable</u></a>	10
<a href="#"><u>1.1.2 Connect the EQUALINK Measuring Cables to the EQUALINK C Modules</u></a>	10
<a href="#"><u>1.1.3 Connect EQUALINK Bus Cables to Converter &amp; Webmanager</u></a>	13
<a href="#"><u>1.1.4 FINISH Step 1: Finish the Installation of the EQUALINK Hardware</u></a>	15
<b>2. <a href="#"><u>Configuration of the EQUALINK WEBMANAGER</u></a></b>	<b>15</b>
<a href="#"><u>EQUALINK WEBMANAGER</u></a>	15
<a href="#"><u>EQUALINK WEBMANAGER LED Status</u></a>	16
<a href="#"><u>2.1 Setup and Network Configuration of the EQUALINK WEBMANAGER</u></a>	16
<a href="#"><u>2.1.1 Installation/Network Integration of the EQUALINK WEBMANAGER</u></a>	16
<a href="#"><u>2.1.2 Network Integration of the EQUALINK WEBMANAGER</u></a>	17
<a href="#"><u>2.1.3 Testing the Network Connection</u></a>	17
<a href="#"><u>2.1.4 Setup the http-connection and login</u></a>	18
<a href="#"><u>2.1.5 Configuration of IP Address/EQUALINK System on EQUALINK WEBMANAGER</u></a>	18
<a href="#"><u>2.1.6 Switching into the Normal Mode</u></a>	18
<a href="#"><u>2.1.7 UPS Configuration</u></a>	18
<b>3. <a href="#"><u>Quickstart - EQUALINK Configuration</u></a></b>	<b>18</b>
<a href="#"><u>3.1 EQUALINK Configuration</u></a>	18
<a href="#"><u>3.1.1 Addressing the EQUALINK Modules</u></a>	19
<a href="#"><u>3.1.2 Enter Battery Information</u></a>	19
<a href="#"><u>3.1.3 Enter EQUALINK SETUP PAGE to Address your EQUALINK Modules</u></a>	21
<a href="#"><u>3.1.4 Start Addressing the EQUALINK Modules using the Setup Automatic Tool</u></a>	22
<b>4. <a href="#"><u>Quickstart - Starting EQUALINK the First Time</u></a></b>	<b>23</b>
<a href="#"><u>4.1 (Optional) Using the EQUALINK SETUP page in Manual Mode</u></a>	24
<a href="#"><u>4.2 (Optional) Set Selected Addresses to 0</u></a>	26
<a href="#"><u>4.3 EQUALINK Module &amp; Alarm Threshold Settings</u></a>	26
<a href="#"><u>4.3.1 Configuration of EQUALINK Module &amp; Alarm Threshold</u></a>	26
<a href="#"><u>4.3.2 Configuration of EQUALINK Offset Values</u></a>	28
<b>5. <a href="#"><u>Monitoring with EQUALINK</u></a></b>	<b>28</b>
<a href="#"><u>5.1 Monitoring with EQUALINK STATUS PAGE</u></a>	28
<a href="#"><u>5.2 Monitoring with EQUALINK AUX / Dry contacts</u></a>	32
<b>6. <a href="#"><u>Analysis of the Battery Data with EQUALINK Viewer</u></a></b>	<b>32</b>
<a href="#"><u>6.1 Installation of the EQUALINK Viewer</u></a>	32
<a href="#"><u>6.2 Add EQUALINK Device, Autosynchronization of the EQUALINK Data</u></a>	33
<a href="#"><u>6.3 Synchronization of the EQUALINK Data Manually</u></a>	35
<a href="#"><u>6.4 Deleting EQUALINK Data from EQUALINK Webmanager and Local Computer</u></a>	36
<a href="#"><u>6.5 Import EQUALINK Data</u></a>	37
<a href="#"><u>6.6 Starting EQUALINK Data Analysis</u></a>	38
<a href="#"><u>6.6.1 Voltage Analysis with the EQUALINK Viewer</u></a>	38
<a href="#"><u>6.6.2 Tool "Zoom-In"</u></a>	41

<a href="#"><u>6.6.3</u></a>	<a href="#"><u>Tool “Zoom-Out”</u></a>	41
<a href="#"><u>6.6.4</u></a>	<a href="#"><u>Tool “Reset Zoom”</u></a>	42
<a href="#"><u>6.6.5</u></a>	<a href="#"><u>Tool “Pan”</u></a>	42
<a href="#"><u>6.6.6</u></a>	<a href="#"><u>Tool “Identify Batteries”</u></a>	42
<a href="#"><u>6.6.7</u></a>	<a href="#"><u>Tool “Suppress Recording Gaps”</u></a>	43
<a href="#"><u>6.6.8</u></a>	<a href="#"><u>Tool “Highlight Batteries”</u></a>	44
<a href="#"><u>6.6.9</u></a>	<a href="#"><u>Tool “Isolate Batteries”</u></a>	45
<a href="#"><u>6.7</u></a>	<a href="#"><u>Current Analysis (Optional EQUALINK_CS Current Sensor Required)</u></a>	45
<a href="#"><u>6.8</u></a>	<a href="#"><u>Temperature Analysis with the EQUALINK Viewer</u></a>	46
<a href="#"><u>6.9</u></a>	<a href="#"><u>RI Impedance Analysis with the EQUALINK Viewer</u></a>	48
<a href="#"><u>6.9.1</u></a>	<a href="#"><u>RI Impedance Analysis with the EQUALINK Viewer Baseline</u></a>	49
<a href="#"><u>6.10</u></a>	<a href="#"><u>EQUALINK Balancing Voltage Analysis</u></a>	51
	<b><a href="#"><u>7. Other Menus in the EQUALINK VIEWER</u></a></b>	<b>52</b>
<a href="#"><u>7.1</u></a>	<a href="#"><u>Menu FILE</u></a>	52
<a href="#"><u>7.2</u></a>	<a href="#"><u>Menu EDIT/Settings</u></a>	52
<a href="#"><u>7.3</u></a>	<a href="#"><u>Menu FTP</u></a>	53
<a href="#"><u>7.4</u></a>	<a href="#"><u>Menu EXPORT</u></a>	53
<a href="#"><u>7.5</u></a>	<a href="#"><u>Menu Equalization/Balancing</u></a>	53
<a href="#"><u>7.6</u></a>	<a href="#"><u>Menu Recording Gaps</u></a>	54
<a href="#"><u>7.7</u></a>	<a href="#"><u>Menu View</u></a>	54
	<b><a href="#"><u>8. EQUALINK Status</u></a></b>	<b>54</b>
	<b><a href="#"><u>9. EQUALINK Accessories</u></a></b>	<b>55</b>
<a href="#"><u>9.1</u></a>	<a href="#"><u>EQUALINK BUS CONVERTER II</u></a>	55
<a href="#"><u>9.2</u></a>	<a href="#"><u>EQUALINK BUS CONVERTER III</u></a>	56
<a href="#"><u>9.3</u></a>	<a href="#"><u>EQUALINK SPLITTING BOX</u></a>	57
<a href="#"><u>9.4</u></a>	<a href="#"><u>EQUALINK CSxxx Current Sensors</u></a>	57
<a href="#"><u>9.5</u></a>	<a href="#"><u>EQUALINK Control Cabinets Type 1 – 4</u></a>	60
	<b><a href="#"><u>10. EQUALINK FAQ</u></a></b>	<b>61</b>
<a href="#"><u>A.</u></a>	<a href="#"><u>EQUALINK Buscabeling – Technical Description and Examples</u></a>	65
<a href="#"><u>B.</u></a>	<a href="#"><u>Hoppecke Monitoring Screws</u></a>	67
<a href="#"><u>C.</u></a>	<a href="#"><u>Installation Instruction external Temperature Sensor from EQUALINK Rev. 3.x</u></a>	67
<a href="#"><u>D.</u></a>	<a href="#"><u>Storage of the EQUALINK Webmanager Configuration</u></a>	69
<a href="#"><u>E.</u></a>	<a href="#"><u>Updating of the EQUALINK Firmware</u></a>	70
<a href="#"><u>F.</u></a>	<a href="#"><u>Storage of Batteries with EQUALINK</u></a>	72
<a href="#"><u>G.</u></a>	<a href="#"><u>EQUALINK Events/Alarms Description</u></a>	72
<a href="#"><u>H.</u></a>	<a href="#"><u>EQUALINK II SNMP MIB Overview</u></a>	73
<a href="#"><u>I.</u></a>	<a href="#"><u>EQUALINK MODBUS Parameter</u></a>	76
<a href="#"><u>J.</u></a>	<a href="#"><u>EQUALINK Maintenance</u></a>	78
<a href="#"><u>K.</u></a>	<a href="#"><u>CS121/EQUALINK WDP – Watchdog &amp; Powermanager</u></a>	79
<a href="#"><u>L.</u></a>	<a href="#"><u>Table of Figures</u></a>	80

# Battery Management with EQUALINK

## General Information

The EQUALINK Battery Management System, now the 2<sup>nd</sup> generation, is one of the most advanced products on the market today providing an Ethernet-network integrated battery monitoring and management system. Using web-management technology, it checks the internal resistance, temperature and the voltage of every single battery cycle. Through a voltage balancing process it corrects and manages the charging voltage of each battery and additionally manages environmental values (temperature, humidity, concentration of hydrogen gas, etc.) and other power devices (UPS, inverters, rectifiers etc.).

The batteries are kept in the optimal voltage operating range. The continuous monitoring and limitation of the single charging voltage of each battery causes a guaranteed availability of the batteries at any time.

EQUALINK is the ideal system for all lead-based batteries (open/wet, maintenance free, gel, AGM), etc.

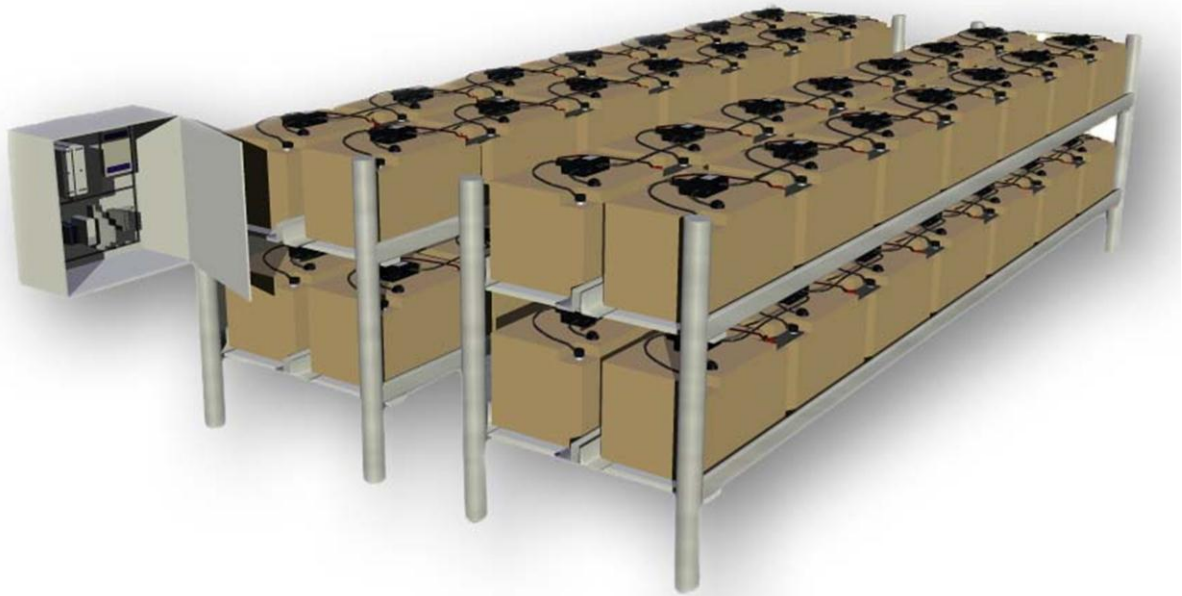

Figure 1: Diagram of a typical EQUALINK system setup

The EQUALINK system is designed for the individual monitoring and control of each of the batteries in the battery system and regulates the voltage symmetry during the charging process and provides warnings in case of asymmetric discharging or other failures.

The EQUALINK system provides charging control for each battery. The voltage from the charging device/UPS will be distributed evenly to all batteries through the patented **STORAGE BATTERY SYSTEMS' EQUALINK Balancing Process**. The result is an equal voltage on all batteries in the system thereby increasing the service life and capacity of the total battery system.

The system stops the overcharge of single batteries and warns in case batteries go into deep discharge. The damaging of weak batteries through overcharge or unnoticed deep discharging is now avoided. Problems of sulphation because of not fully charged batteries in standby is minimized through a constant trickle charge through the EQUALINK Balancing Process. Because the EQUALINK system detects such problems the user is able to identify and act before the battery reaches a damaged and non-recoverable situation. (e.g. by a controlled discharging process the sulphation may be removed). Complex and costly manual monitoring and maintenance work are no longer necessary. The total battery data of every single battery is now available at any time through the network.

Should the EQUALINK Balancing Process not be able to overcome the voltage level of a problem battery then the replacement of this single battery should take place, before it interferes with nearby batteries. The single battery with performance impacting the entire battery system belongs in the past. The battery can be managed at any time and help the battery reach the life span as declared by the battery manufacturer.



EQUALINK secures the availability of the battery system and the optimum capacity through the constant monitoring of the batteries and builds the basis for the decision to extend the lifespan of a battery system.

EQUALINK provides the most economic monitoring for every single battery within the battery system with extensive analysis of the battery data. EQUALINK is available for small (7 Ah) and big stationary lead batteries up to 6000 Ah – in 4 versions (2V, 4V, 6V, 12V).

The EQUALINK system has an actual alarm threshold system and a database for battery history. The system reads and stores the individual battery values for internal resistance, temperature and voltage. If the optional EQUALINK\_CS current sensor is attached, the DC currents at charge and discharge will be stored for analysis. The data is transmitted via the bus-system to the **EQUALINK WEBMANAGER**.

The EQUALINK WEBMANAGER is the central control unit for the system, where all information is interpreted and stored. A display or Alarm LED and buzzer informs about the actual status of the batteries. It provides the web-interface for the comfortable configuration and display of all system values.

The EQUALINK WEBMANAGER constantly calculates the reference value of the charging voltage - every battery should have the correct overall voltage. If any battery deviates from the average charging voltage, the EQUALINK WEBMANAGER sends a correction command to this specific EQUALINK module to manage this battery. This individual charging/discharging of batteries is the patented Balancing Process.

The values for the internal resistance, voltage, temperature, the delimiter of the activity and the amount of the charging and discharging processes will be collected and monitored through the EQUALINK WEBMANAGER. Accordant alarms will be routed via the network or (optional) modem, email, SMS, SNMP or RCCMD. The alarm system provides an audible sound via a local buzzer and an Alarm LED plus dry contacts for external interfaces. Alarms are also readable in the MODBUS format at one of the serial interfaces and/or over MODBUS over IP.

The EQUALINK WEBMANAGER has an internal Flash-ROM of at least 32MB, which is able to store all battery data up to 3 years (depending on number of batteries, alarms and battery discharges) due to optimized storage routines. All data stored on the EQUALINK WEBMANAGER can be downloaded and archived via the network.

Alarms at the battery or other devices, which are connected to the load, will be logged with date and time. The EQUALINK WEBMANAGER is provided with an automatic synchronization to a timeserver in the network, to report all data and alarms in a chronological file for log reporting.

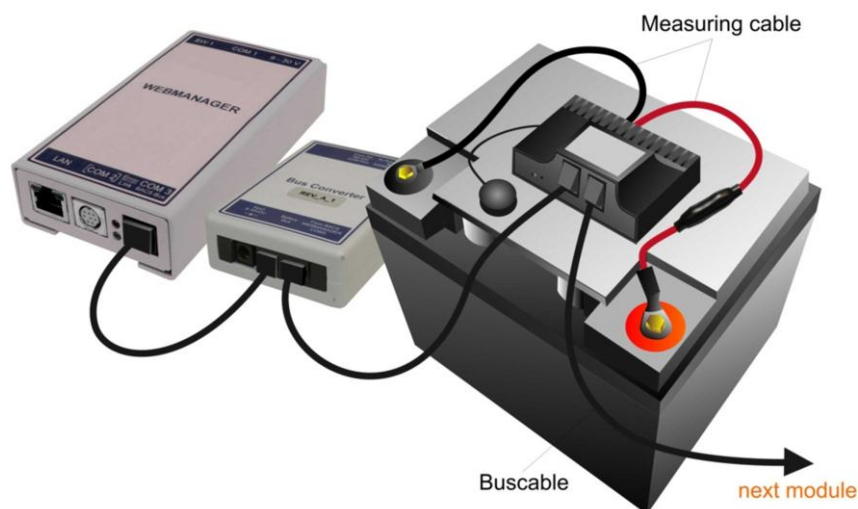

Figure 2: EQUALINK WEBMANAGER typical setup

## EQUALINK Components

### EQUALINK Battery C-Modules

The control of the charging and discharging activity of each battery during the Equalization/balancing process and the measuring of the actual state of the battery is transmitted through the EQUALINK C-modules, which are mounted on every battery. The accordant C-module for your battery system is depending on the battery type (Voltage) and its dimensions. Take a look into the actual EQUALINK Component Sheet for the key data of the available C-modules.



Figure 3: EQUALINK C20 REV 1.4/2.2 Module – EQUALINK C20 REV 3 Module.

**NOTE: EQUALINK C20 modules from Rev. 2.1 and EQUALINK C41/42 modules from Rev. 1.1:** These EQUALINK modules have an improved ECO mode and will automatically switch off to save energy if no communication is present. After 4 seconds of bus activity (e.g. through EQUALINK Programmer or EQUALINK Web manager polling) all modules will “wake up” and are ready for programming.

**EQUALINK Measuring Cables**

This is the cable for measuring the voltage and impedance of the connected battery. It is a 4 wire cable with 2 fuses in the positive cable (red) to protect the EQUALINK system against high currents or short circuits. This cable has to be firmly fixed on the battery terminal and should be installed before the EQUALINK modules are connected.



**EQUALINK Bus Cables**

The EQUALINK bus cable is the highway communication bus between all EQUALINK modules in a battery system. This cable is specially shielded against EMI and is calibrated to guarantee a safe communication in most environments. The cable length should be optimized, the shorter the cable the less risk of EMI problems.



**EQUALINK WEBMANAGER Kit**

The EQUALINK WEBMANAGER is the central controller unit of the battery system and communicates with all the batteries via the EQUALINK bus. The EQUALINK WEBMANAGER Kit consists of the EQUALINK CONVERTER, the EQUALINK WEBMANAGER itself and several spare cables and power supplies. The EQUALINK WEBMANAGER has to be connected to the EQUALINK communication cables to start the configuration and monitoring process.

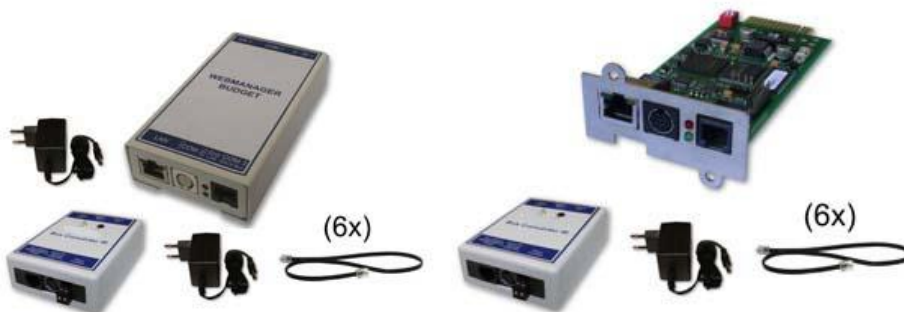

Figure 4: EQUALINK WEBMANAGER external kit (left), slot version kit (right), with spare cables



Figure 5: EQUALINK WEBMANAGER II with Integrated EQUALINK CONVERTER

The EQUALINK WEBMANAGER system includes a fully qualified SNMP / Web UPS manager at COM 1. Additionally any EQUALINK WEBMANAGER system offers as options several sensors for DC current, (EQUALINK\_CS), room temperature and humidity (SM\_T\_COM or SM\_T\_H\_COM), plus other environmental and customized sensors (SENSORMANAGER). Also available is a management software for managing multiple remote EQUALINK monitoring sites. The Mangement System provides this service and is available and for automatic messaging and shutdown of computers via the module RCCMD – “remote console command”. The full product portfolio from Storage Battery Systems with all optional modules is shown in the figure below.

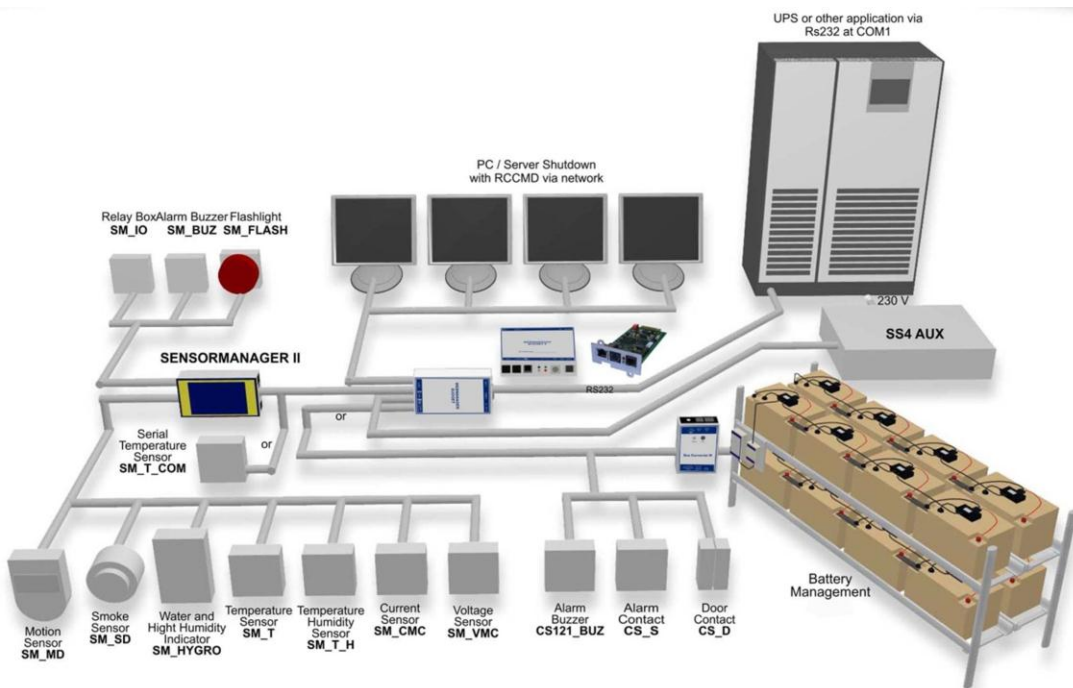

Figure 6: Overview of Optional Modules for an EQUALINK System

### EQUALINK RAS WEBMANAGER

The EQUALINK RAS (Remote Access Server) WEBMANAGER provides the remote monitoring of systems which have no network connection on-site or require a connection via telephone. Please review the [RAS Manager user manual](#) for further information. The EQUALINK RAS Webmanager requires an external EQUALINK BUS CONVERTER III.



Figure 7: EQUALINK RAS WEBMANAGER II with Integrated Modem  
Equalink Instruction Manual, Page 9

# 1. Quickstart - Installation of the EQUALINK Hardware

The installation of EQUALINK consists of 4 major steps, each of these steps are described as “Quickstart” in chapters 1 to 4. Please review the EQUALINK User Manual and EQUALINK Viewer Manual for further information.

## 1.1 Installation of EQUALINK Cables, Module, Converter & Splittbox

### 1.1.1 Assemble the EQUALINK Measuring Cable

Assemble the supply- and measuring cables (Part No. BC2MCxxx) to the battery terminals. Please note the right polarity, red cable at the plus terminal (+), black cable at the minus terminal (-). Please tighten the terminal and monitoring screws with the torque as denoted by the manufacturer.

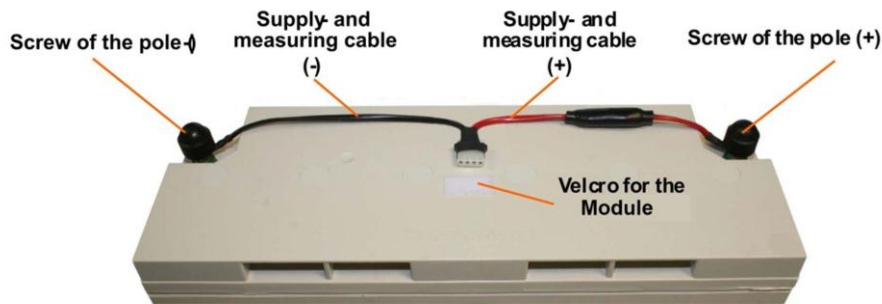
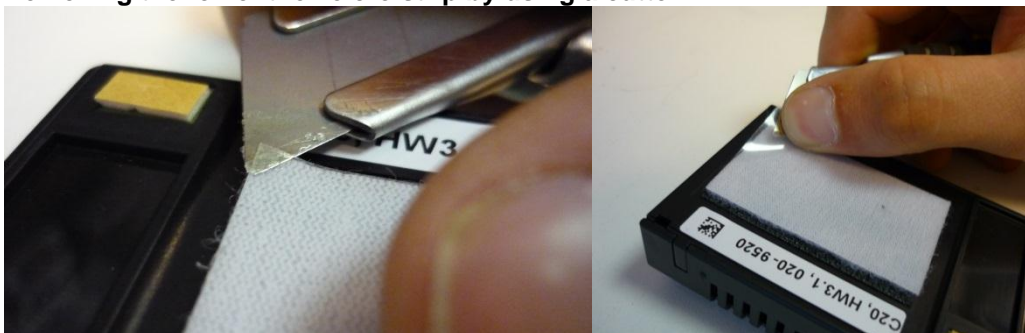

Figure 8: Typical Assembling of an EQUALINK Measuring Cable

### 1.1.2 Connect the EQUALINK Measuring Cables to the EQUALINK C Modules

After installing the EQUALINK measuring cables, connect the 4 Pole connector with the EQUALINK modules. Insert the connector until you can feel that the lock is closed. Remove the velcro from the module and detach the foil (most suitable is a cutter, look at the picture below). Contact the velcro under high pressure on a suitable place of the battery, see picture below. The contact pressure is important for an optimal contact. At REV 3, 2 foils have to be removed. The smaller one is for the integrated temperature sensor into the housing, which should be in contact with the surface of the battery. Make sure that the surface is clean to ensure a proper fixing of the sensors to the surface. For the degreasing/cleaning we recommend to use only solvents which are recommended by the battery manufacturer. If you are unsure, then simply use soapy water and clean and dry the surface carefully.

Removing the foil of the velcro strip by using a cutter:





Removin the foil of the temperature sensor by using a cutter:



Bonding of the velcro on the battery:



Optional REV 3: You can order an external temperature sensor for the REV 3. This one will be mounted as the REV 2 as follows.

REV 2: This type of C Module has a temperature sensor on a 10cm cable which has to be placed on the battery surface. Detach the foil at the temperature sensor and place the sensor nearby the housing of the battery (not on cooling fins nor closing plugs). Please make sure that the surface is clean to assure an accurate attachment of the sensor.

**Note:** Do not install different EQUALINK C module versions on the EQUALINK bus. E.g. you cannot use EQUALINK C REV 1.3 together with EQUALINK C REV 2.2 in the same system; the EQUALINK bus will refuse to start working unless all C modules are same hardware revisions.

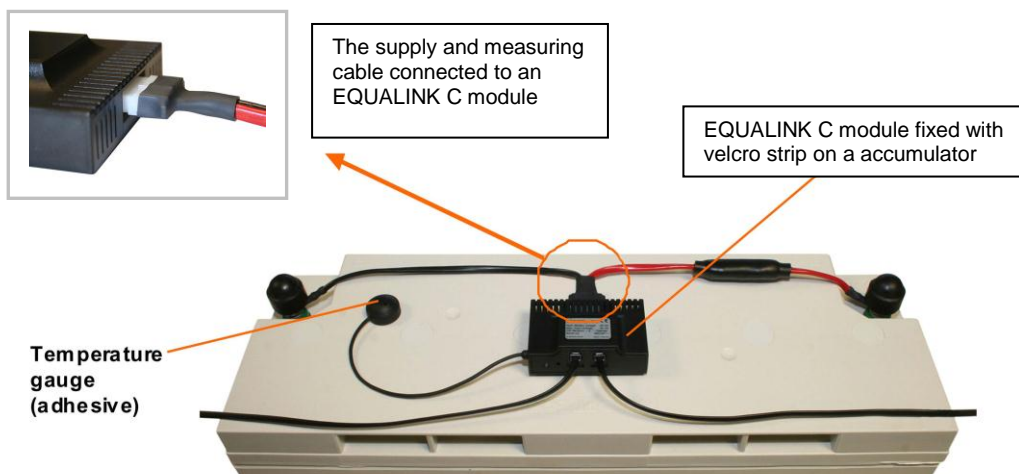

Figure 9: Assembling and Connection of the Module

All modules should be connected together via the RJ10 bus-cables (Part No. *B2BCRJ10xxx*) using the 2 sockets at the back of the EQUALINK module. Using the bus-cables, connect all the modules in series (any socket of the EQUALINK module can be used, it does not matter if left or right socket). The last cable has to be connected to the EQUALINK BUS CONVERTER or to the EQUALINK WEBMANAGER Input.

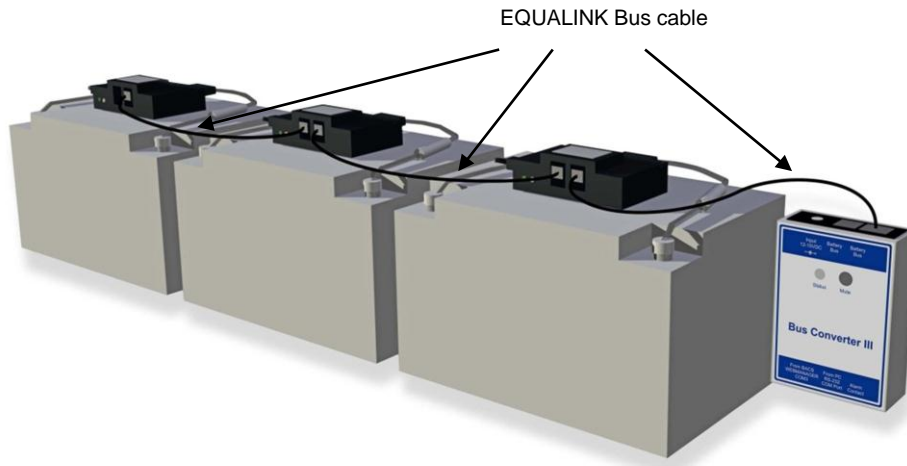

Figure 10: EQUALINK Bus Cables (Part No. B2BCRJ10xx) Connected to an EQUALINK CONVERTER

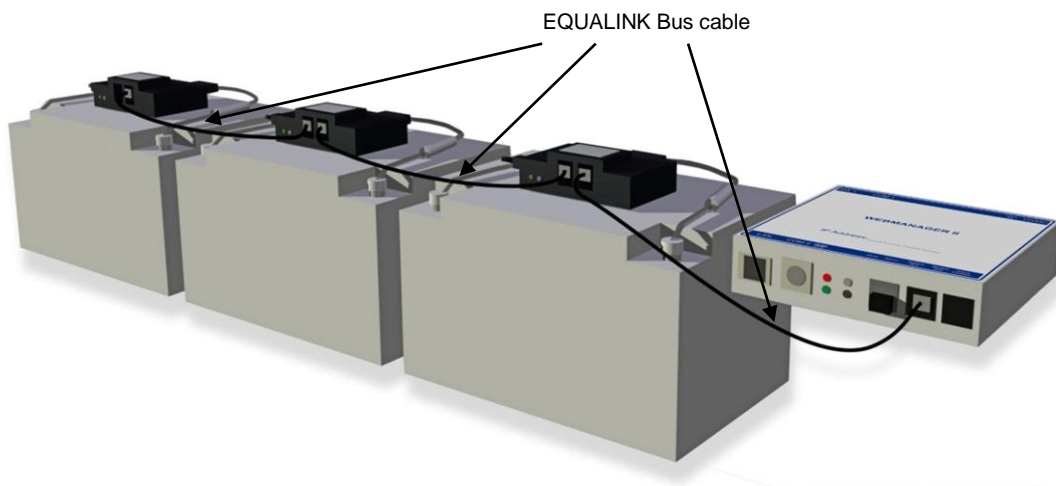

Figure 11: EQUALINK Bus Cables connected to an EQUALINK WEBMANAGER II Internal CONVERTER

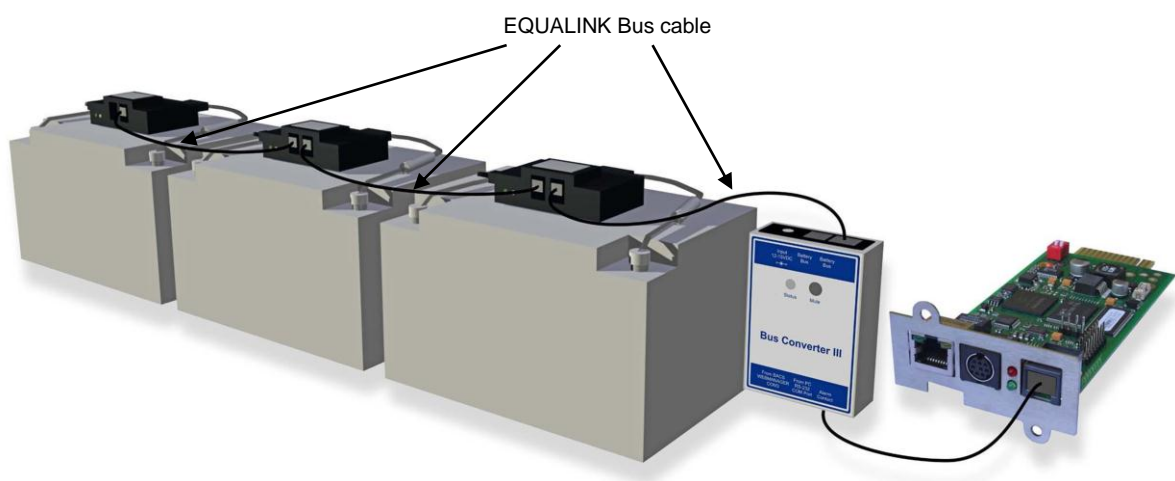

Figure 12: EQUALINK bus cables connected to an EQUALINK WEBMANAGER Slot version - For usage with UPS, Inverters, Rectifiers, Chargers or other devices with such a compatible slot type

For battery systems with more than 50 batteries, we recommend the usage of an **EQUALINK Splitting Box** (Part. No. BCII\_SPLITT). A SPLITTINGBOX is for avoiding extreme bus cable length and allows the installation engineer to optimize the bus cable route for tidy installation.



Figure 13: EQUALINK SPLITTING BOX

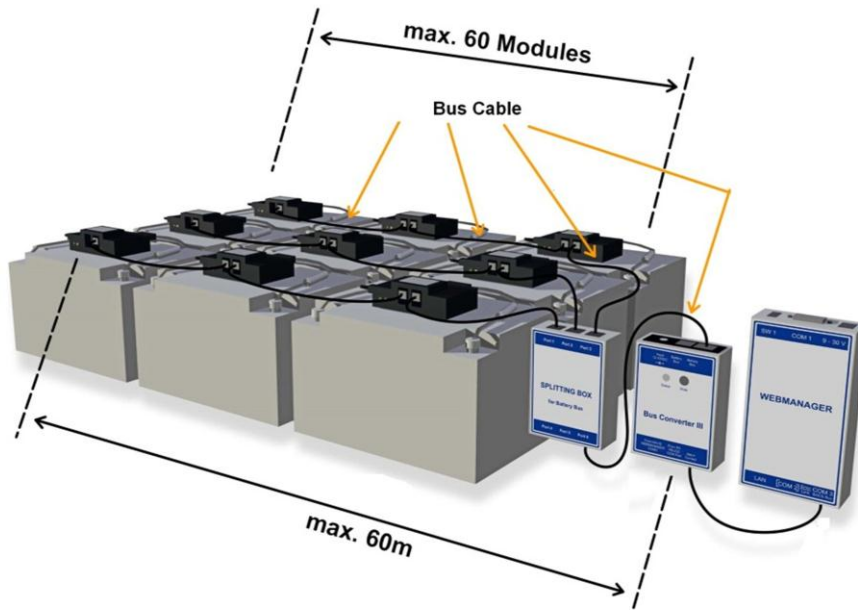

Figure 14: EQUALINK Bus Cables connected to a SPLITBOX - CONVERTER – EQUALINK WEBMANAGER

The EQUALINK bus connection cables are specially-designed products (using twisted cables and special covering); the cables are available in different lengths. We strongly recommend using these cables to avoid false alarms through EMI or other noise.

**Tip** You can connect the modules to the bus in random order. It is not necessary to connect the modules to the bus in serial (i.e. in a 'daisy-chain'). We recommend arranging the bus wiring in such a way as to avoid excessive bus cable length.

**Tip** The bus system can be carried out in a closed loop for better data transfer. In case of one contact problem in the circuit, problems can still be detected.

### 1.1.3 Connect EQUALINK Bus Cables to Converter & Web manager

The EQUALINK BUS CONVERTERS provide a galvanic isolation of the battery bus from the EQUALINK WEBMANAGER; additionally, it filters possible EMI and converts the EQUALINK bus protocol to an RS232 protocol. The active EMI filter in the EQUALINK BUS CONVERTER requires a power supply 12 – 18 VDC.

The EQUALINK Battery bus cables are connected to the first EQUALINK module in your system or to the EQUALINK SPLITTINGBOX. The other side has to be connected with the EQUALINK WEBMANAGER, using the included 1 m cable.



**Attention!** Do not connect any EQUALINK bus cables type B2BCRJxxx into the COM3/AUX port of the EQUALINK WEBMANAGER. This port is designed for the usage with the 6-pin original cable, which is

contained with of every EQUALINK WEBMANAGER. If any other cable will be connected here, it could damage the contacts and might cause addressing and communication problems with your EQUALINK BUS CONVERTER and EQUALINK Modules!

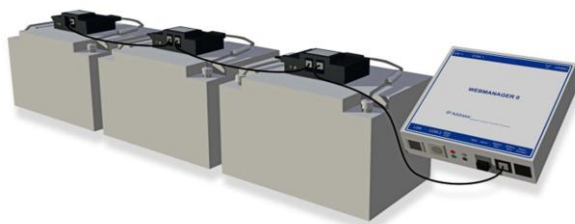

Figure 15: EQUALINK WEBMANAGER II Typical Setup

There are several different types of EQUALINK BUS CONVERTERS. Depending on your model, please connect the EQUALINK Bus cable from the first module or EQUALINK Splitting box to the EQUALINK BUS CONVERTOR and install the Power supply cable to the box. The Bus cables connect the convertor to the EQUALINK WEBMANAGER. If you are installing the EQUALINK WEBMANAGER 2 the BUS CONVERTER is now incorporated into the EQUALINK WEBMANAGER and no extra power supply is required. The EQUALINK cable from the first module or EQUALINK splitting box is connected directly to the EQUALINK WEBMANAGER.



Figure 16: EQUALINK WEBMANAGER II with Integrated CONVERTER



Figure 17: EQUALINK Bus Converter III for use with EQUALINK WEBMANAGER slot cards and standard



## 1.1.4 FINISH Step 1: Finish the Installation of the EQUALINK Hardware

The installation of the EQUALINK sensor, consisting of EQUALINK measuring cables, EQUALINK C modules, EQUALINK bus cables, EQUALINK SPLITTING BOX and EQUALINK CONVERTER is now finished.

At this point the EQUALINK modules are not yet functional. The modules are not addressed yet generally you can do this via the EQUALINK PROGRAMMER Software (for Windows) or via the EQUALINK WEBMANAGER directly. Now we have to configure the EQUALINK WEBMANGER to set up the addressing of the Modules.

The installation of the hardware is now finished. Please see chapter 2 for the configuration of the EQUALINK WEBMANAGER.

## 2. Configuration of the EQUALINK WEBMANAGER

### EQUALINK WEBMANAGER

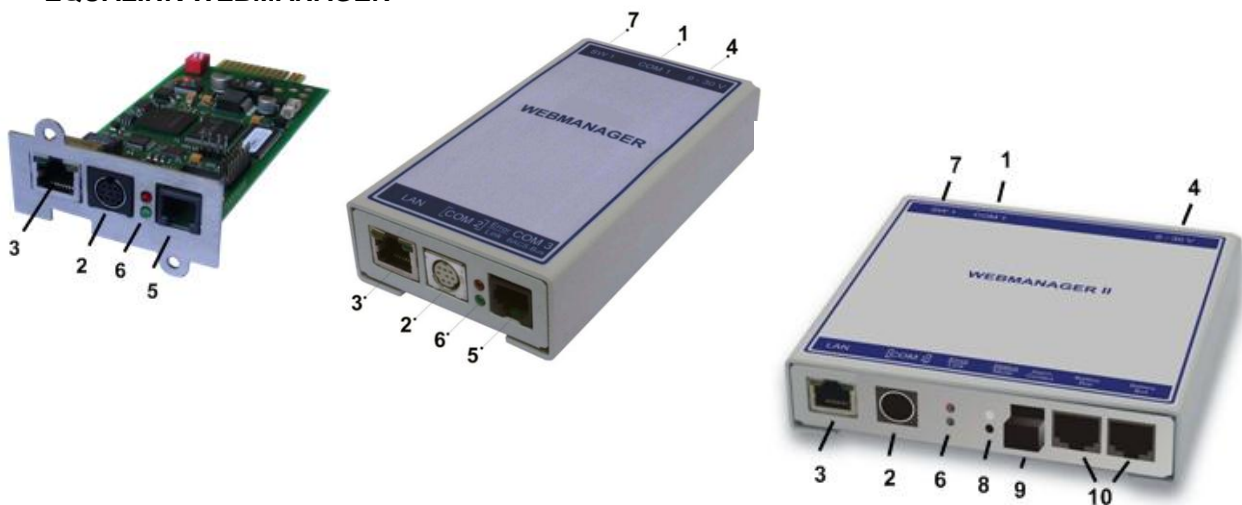

Figure 18: EQUALINK WEBMANAGER external, this is also available as SLOT card for UPS

Description	Function
1 COM1 connector	Connection with an UPS or another end-device via a RS232-cable.
2 COM2 connector	Connection for optional devices like a modem, multi sensor SENSOR MANAGER, temperature sensor, humidity, field busses (MODBUS, RS232, Profibus, LONBus, etc.).
3 LAN-Socket	Ethernet 10/100 Mbit interface with integrated LEDs (green LED: connection to the network established, yellow LED: network-activity).
4 DC-Input	Power supply 12VDC/1A stabilized through external power supply, DC-connector inside (-) minus, outside (+) plus.
5 COM3 connector	For the connection to the EQUALINK CONVERTER (at II/III internal), max.1m Rj12/6pole cable

6 LEDs (red and green)	Optical displays (red = Boot process/error, green = ok).
7 DIP-Switch	For the switch between configuration mode (both switches off) and normal mode (switch 1 on, switch 2 off).
8 Alarm LED	Alarm LED of the integrated CONVERTER (II only).
9 MUTE Button	Button to acknowledge and mute the alarm. Alarm LED changes to yellow.
10 EQUALINK Bus	2 x RJ10 ports for connection to the EQUALINK C-Module / SPLITTINGBOX / EQUALINK_CSXXX / GX_R_AUX devices.

## EQUALINK WEBMANAGER LED Status

Operating Conditions of EQUALINK Web Manager LEDs	LED-Signalling
Start procedure 1, uploading of the OS	Red flashing
Start procedure 2, reboot of the OS	Red long on
If the red and green LED activate at your EQUALINK Webmanager during the reboot, large broadcast traffic is present on your network "receive buffer overflow". The green LED is signaling at the reboot, that the "traffic buffer" is full. Advice: You should filter broadcasts via your switch, because it reduces performance of the EQUALINK Webmanager unnecessarily.	Red AND green during reboot
Normal condition	Green flashing
UPS communication lost	Red constantly

## 2.1 Setup and Network Configuration of the EQUALINK WEBMANAGER

**i** Note: We recommend the following settings for the operation of the CS121 via cross cable (Ethernet cable for a direct connection). Set the IP address of the PC with a cross cable to an IP address of the same network segment, e.g. 10.10.10.10 AND set the gateway to 0.0.0.0.

### 2.1.1 Installation/Network-Integration of the EQUALINK WEBMANAGER

Connect the power supply to the EQUALINK WEBMANAGER and connect a network cable to your Network Switch or to your PC/ workstation network card (cross cable required).

A network cross cable is a PC-PC network cable which does not require a switch or a hub between 2 network computers (2). If you do not have such a cross cable, please connect the EQUALINK WEBMANAGER and your PC to a switch or hub (1).

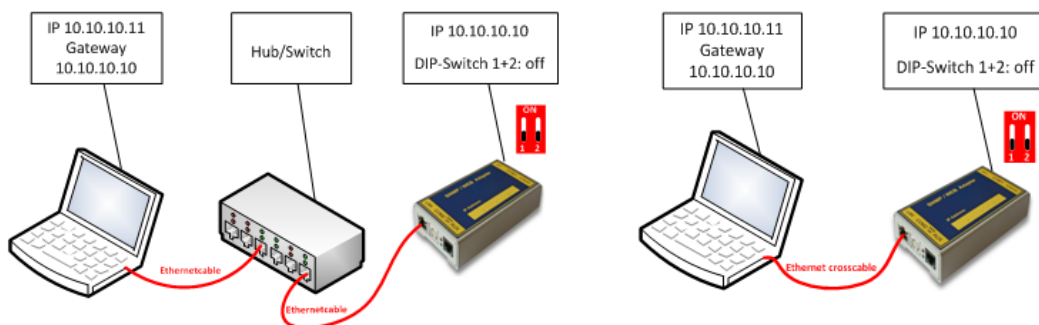

Figure 19: (1) Connection PC-Switch/Hub and CS121 (2) Connection PC-Cross-Cable/Network Cable and CS121

An EQUALINK WEBMANAGER Slot (slot card for UPS with SC-Slot) is supplied via the internal power supply of the UPS.



Figure 20: EQUALINK WEBMANAGER SLOT card for UPS

**NOTE:** You can remove and re-insert the slot card to the UPS at any time - (e.g.: to interrupt the power supply for the EQUALINK WEBMANAGER). The UPS function is not affected by removing/inserting a Slot card.

### 2.1.2 Network integration of the EQUALINK WEBMANAGER

**DIP-Switch:** (allocated on the top of the SLOTCARD, at external versions on the rear side) Set the DIP-Switch 1 and 2 into the position OFF. This activates the configuration-mode of the EQUALINK WEBMANAGER and its IP address 10.10.10.10.

Automatic IP Addressing: If you set DIP SW 2 to Position ON, DHCP is enabled and the IP address is set automatically. Check the MAC address of your EQUALINK WEBMANAGER to identify the IP address in the DHCP Servers hostname/IP cross reference table.

*(Optional, only if a UPS is connected to COM 1 – if no UPS or other device to manage, skip this step)*

**Connect the WEBMANAGER to the UPS:** Connect the original serial interface cable of your UPS to the COM port 1 of the WEBMANAGER.

**NOTE:** The EQUALINK User Manual describes extensively the Battery management functions. The Network management functions are not described in this manual. For configuration of a UPS, timeserver, SNMP etc. refer to the “**CS121 user manual**”, which is part of this Documentation CD-ROM or available as download from the UPS or EQUALINK Website of your supplier. **The CS121 is fully integrated into your EQUALINK WEBMANAGER and all UPS functions and the general usage of flexible EVENTS etc. are described in this separate manual.**

**For the latest version of the CS121 user manual please follow the link below:**

[CS121 User Manual](#)

### 2.1.3 Testing the Network Connection

To get a connection to the EQUALINK WEBMANAGER through a network cable, you have to integrate it into the IP segment of your computer. In DIP SW 1 position ON the device is set to the default IP address 10.10.10.10. To reach this IP address, you have to set a temporary IP route from your computer.

Open a command prompt window, (open a “DOS BOX” or enter “cmd.exe”) and enter in the command prompt

**“Route add 10.10.10.10 <your local IP address>”**

Example: “route add 10.10.10.10 192.168.222.54”

Now you should be able to send a ping to the WEBMANAGER on address 10.10.10.10 and connect with your web-browser to start the configuration.

Note: The internal web-server takes a while to get started. Approximately 3 to 5 minutes after the first start of the WEBMANAGER; the UPS status LED should change from static red (boot phase) to green flashing. This indicates that the web-server is ready now.

Now you can use a web-browser to connect to the EQUALINK WEBMANAGER via <http://10.10.10.10>

**Contact SBS to get the "Netfinder" Software, which will scan your network environment:**

**(262) 703-5800 or email: [Test@SBSBattery.com](mailto:Test@SBSBattery.com)**

#### **2.1.4 Set up the http-Connection and Login**

Connect the web-browser (MS-Internet Explorer and Mozilla supported) to the address <http://10.10.10.10> to reach the configuration web-interface of the Webmanager. Use for the login the **username "admin"** and the predefined **password "cs121-snmp"**.

#### **2.1.5 Configuration of IP Address/EQUALINK System on EQUALINK WEBMANAGER**

**Basic Network Settings:** Click the "Network & Security" button. Set the "Local Address", "Gateway Address" and "Subnet Mask" ("DNS-Server" if required). Click the "Apply" button to confirm your settings. Click the "Timeserver" button. Set the IP address of a timeserver service. The timeserver settings are important; because of the logging data of events and alarms (if the web-adapter is not able to reach a timeserver, the default time is January 1, 1970). Click the "Apply" button on every page to confirm your changes.

Finally click on "**SAVE, EXIT & REBOOT**" and wait until the web-browser loses the connection to the EQUALINK WEBMANAGER.

#### **2.1.6 Switching into the Normal Mode**

After the EQUALINK WEBMANAGER has rebooted, (takes about 3-5 minutes) it will respond again on IP address 10.10.10.10. To activate the new configured IP address, set the DIP-Switch 1 into the position ON and disconnect the power supply for a cold-boot (power cycle). This time the EQUALINK WEBMANAGER will use the new, configured IP address and does not respond to IP address 10.10.10.10 anymore.

Connect again now with a web-browser to the new configured IP address (<http://<IP address of the adapter>) and continue the SETUP of your system.

**NOTE:** DIP SW 2 is for DHCP – if you set DIP SW 2 to Position ON, the EQUALINK WEBMANAGER will automatically try to get an IP address from your DHCP Server. To find the new IP address of your EQUALINK WEBMANAGER, please refer to your DHCP Servers Mac Address table and compare with the MAC Address label on your EQUALINK WEBMANAGER.

#### **2.1.7 UPS configuration**

**(Optional, only if a UPS is connected to COM 1 – if no UPS or other device to manage, skip this step)**

**UPS Model:** Click the "UPS-Model & System" button. Set your UPS model, which is connected to the WEBMANAGER. Click the "Apply" button to confirm your settings. For further information on how to set-up a UPS in the EQUALINK Webmanager, [refer to the CS121 user manual](#), which is part of this documentation CD ROM or available as download from the UPS or EQUALINK Website of your supplier.

**Step 2 is now finished.**

Your EQUALINK WEBMANAGER is integrated into your network. Please continue now with Step 3: "EQUALINK Configuration".

### **3. Quickstart - EQUALINK Configuration**

#### **3.1 EQUALINK Configuration**

If the EQUALINK modules have not been already pre-addressed by your supplier (optional service, Part No. "EQUALINK\_PGM"), the EQUALINK modules will blink slowly red the moment the EQUALINK WEBMANAGER has been connected. (Default status, address = 0) If all modules have been already been addressed, the EQUALINK modules will show a slow green flashing LED (no EQUALINK communication) or a green static LED (Operating mode).

**i Note:** If your modules are already pre-addressed (displayed via green flashing LED), please continue with step 4!

### 3.1.1 Addressing the EQUALINK Modules

When the red LED is slowly blinking your modules are in default address 0. The new EQUALINK modules will be delivered with the address "0", displayed through this slow flashing red light.

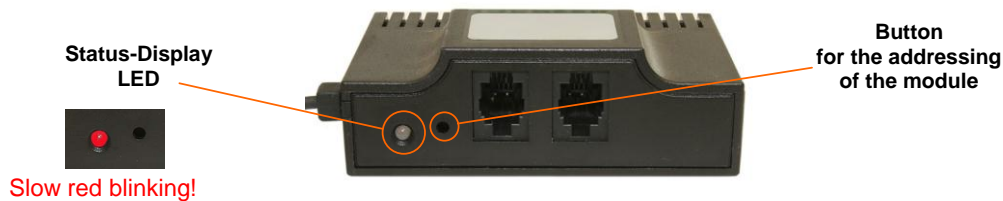

It is required that ALL EQUALINK modules are in this state prior to starting the addressing process!

If this is not the case, please read chapter 4.2, how to reset the EQUALINK modules to factory settings.

### 3.1.2 Enter Battery Information

Go with your web-browser to the "EQUALINK Configuration" menu.

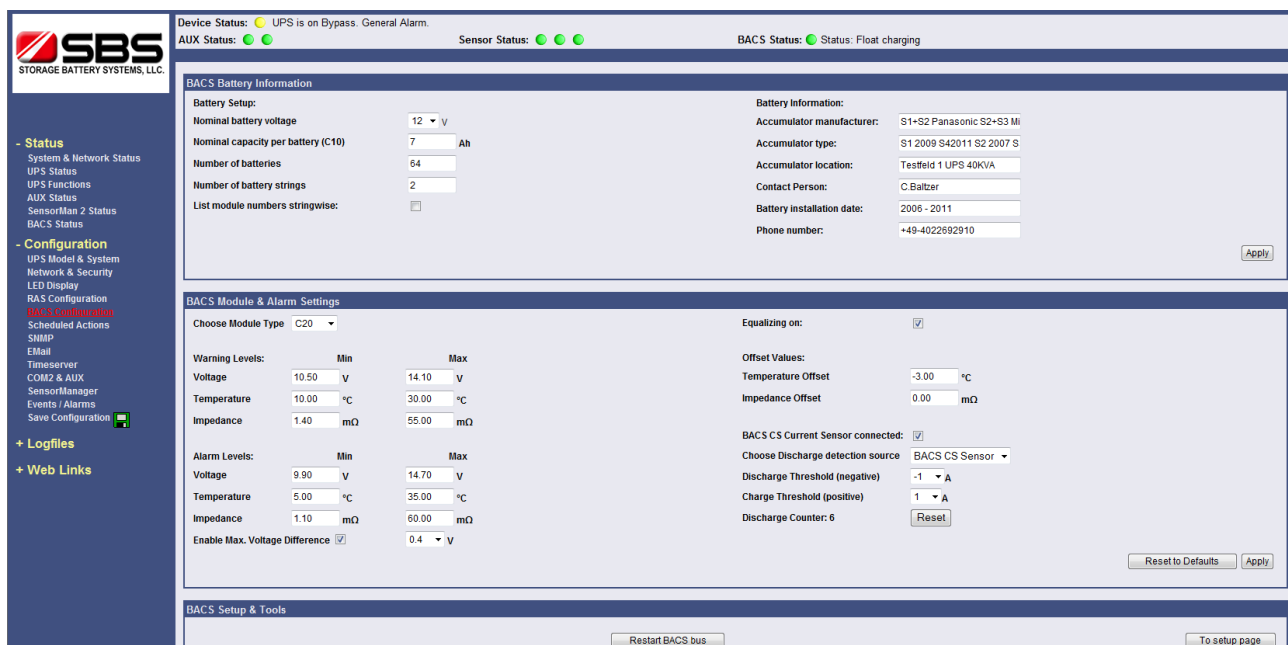

Figure 21: EQUALINK Battery Information

First enter the number of batteries/EQUALINK modules connected to the EQUALINK WEBMANAGER.

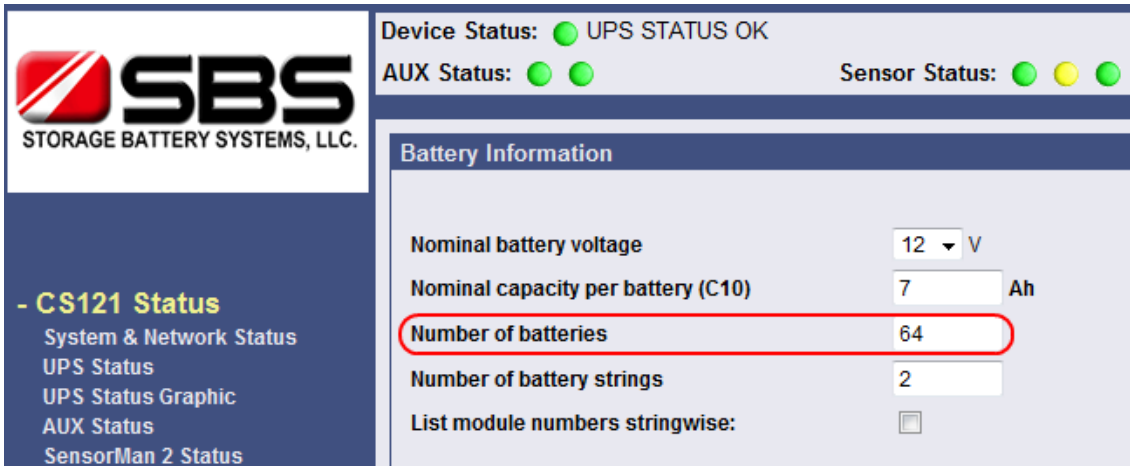

Figure 22: Enter Number of Batteries

E.g. If you have 64 batteries in 2 strings, please enter 64 into the area “Number of batteries” and 2 into “Number of strings”.

After entering the number of battery strings, you may define how the battery is shown in the EQUALINK web-interface EQUALINK STATUS screen. If you check the box “List module numbers string wise”, the EQUALINK STATUS screen will list the address number of the batteries string wise, e.g. at 2 Strings with a total of 64 batteries you will see at string 1 the addresses 1-32 and at string 2 the addresses 1-32.

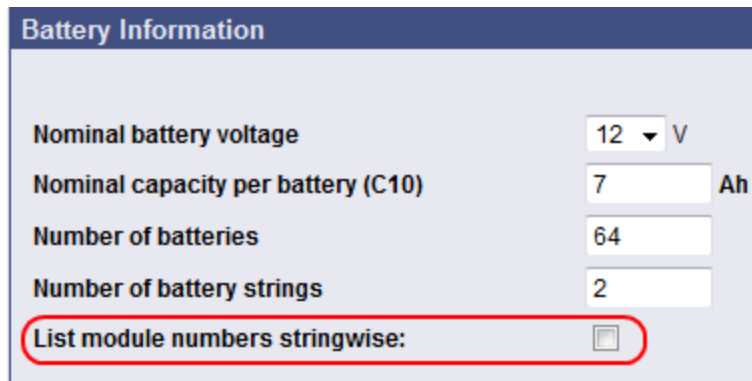

Figure 23: EQUALINK Feature “List module numbers string wise”

If you have enabled the feature “List modules numbers stringwise”, the EQUALINK log file will identify the batteries per string with a text prefix like: “4S2” which means “module 4, string 2”. This makes the identification of the EQUALINK module with an alarm easier for you. The following figure shows the alarm log file of an EQUALINK Web manager where a temperature alarm was present on several modules, here identified with their string number.

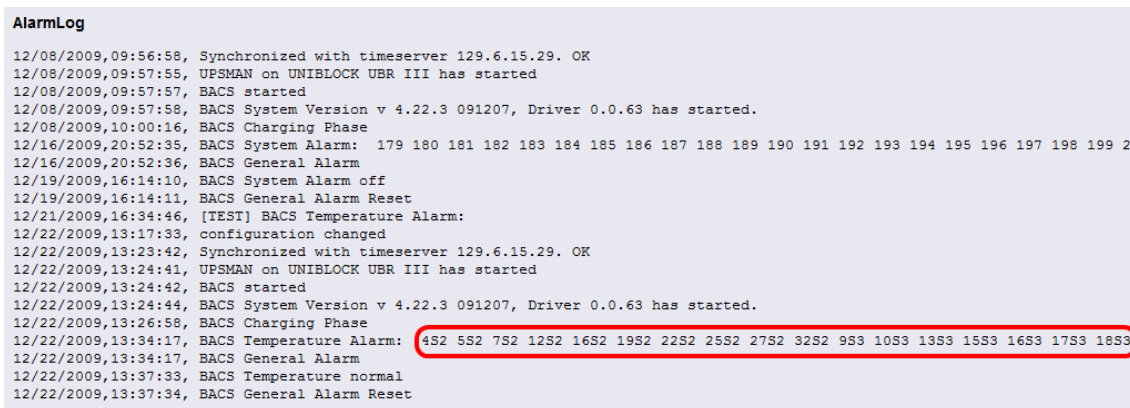

Figure 24: Alarm Log file with temperature alarm on EQUALINK modules with string numbers



**UPS with center tapping / positive and negative strings.** If the battery system of your UPS is using “center tapping” (where one string is the positive string and the other string negative string, both strings have their individual charger) then you have to configure your EQUALINK system with at least 2 strings (or more). Explanation: It should be avoided if the battery voltages between the 2 strings are not the same due to separate chargers for the positive and negative strings. To assure an ideal equalization/balancing at different string voltages (+ and – string), it is required to set the amount of strings into the EQUALINK configuration to “2” or higher. By configuring more than 1 string, the EQUALINK configuration will change the equalization/balancing process to work only within each string. Now every string is handled individually by the EQUALINK system.

(Examples:

2 parallel strings -> EQUALINK configuration number of strings = 4

3 parallel strings -> EQUALINK configuration number of strings = 6; etc.)

The following UPS types are well known to work with 2 strings or more and should not be configured as single string systems: NEWAVE Concept Power Series, AEG Protect Type 3. Modular, Socomec DIGIS, Rittal PMC Extension, INFORM Pyramid DSP.

Please refer to your UPS manufacturer for further information about your UPS system if you are unsure how many strings to enter.



**Note:** The new EQUALINK C-Modules will go into “Sleep” mode automatically, if the EQUALINK WEBMANAGER is not polling. That means that the modules seem to be off, as long as the EQUALINK WEBMANAGER is not connected. To wake up the sleeping modules you have to connect the EQUALINK Web manager and open the configuration page; after a while the modules will wake up.

### 3.1.3 Enter EQUALINK SETUP PAGE to Address your EQUALINK Modules

If all modules are slowly flashing red, click on the “To Setup Page” in the menu “EQUALINK Setup & Tools” button.

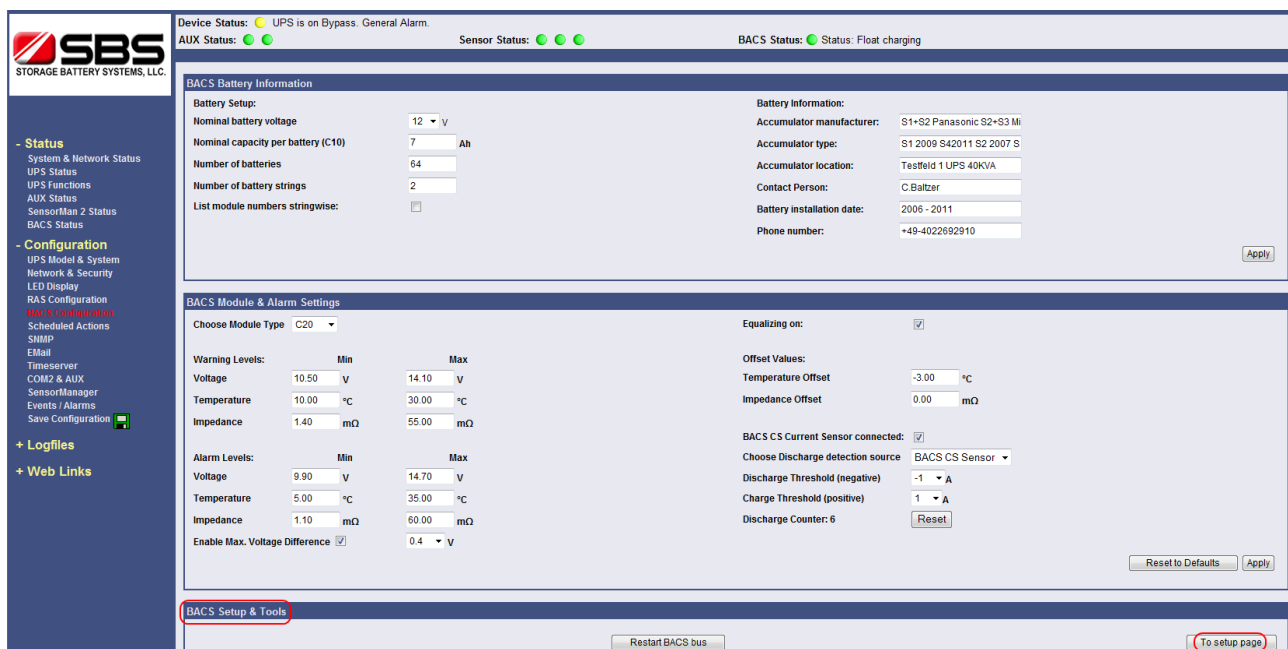

Figure 25: Web Interface EQUALINK Configuration

Click the “Enable” button to interrupt the normal operation of the EQUALINK system. The polling and the initializing of the modules will be stopped. This page offers setup features for the addressing of the EQUALINK modules.



**Do not forget!** After your address work is finished, click the “Disable” button to reactivate the normal operation, the polling and the initializing of the EQUALINK system.



### 3.1.4 Start Addressing the EQUALINK modules using the Setup Automatic Tool

After the page is active, you may now start addressing your EQUALINK modules using the **EQUALINK Setup Automatic Tool**.

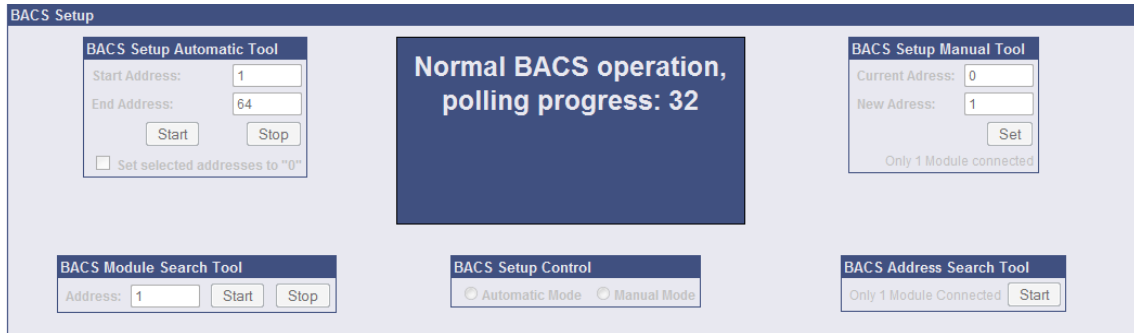

Figure 26: Web-Interface EQUALINK Setup & Tools

#### EQUALINK Setup Automatic Tool

You have the choice between “automatic mode” and “manual mode”. In Automatic mode all modules will be addressed by a consecutive click on the address button of every module starting from no. 1 to the last module. In Manual mode you can set the address numbers individually.

#### EQUALINK Setup Automatic Tool Usage

In the **EQUALINK Setup Automatic Tool** the addresses will be set consecutively. Set a start and an end address. E.g. if you have 64 batteries, set 1 as start address and 64 as end address and click the “Start” button.

The system will now start the addressing mode and you should see that **ALL** modules change from slow red flashing to fast red flashing.

Status-Display LED is **fast red flashing** = Addressing mode active! Press address button with any pointy object to address this module to the next number

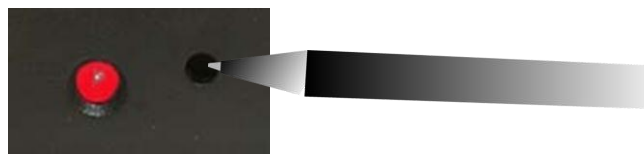

Fast red flashing indicates “addressing mode”. As soon as all modules show fast flashing LEDs, you can automatically address the modules by a short click (with a pen or any other pointy object, e.g. a pen etc.) on the address button in the module. This will make the fast red flashing LED turn green – indicating that you successfully have addressed this module.

If not all the modules flash fast red, please see chapter 4.2 “Reset to Factory Settings”.

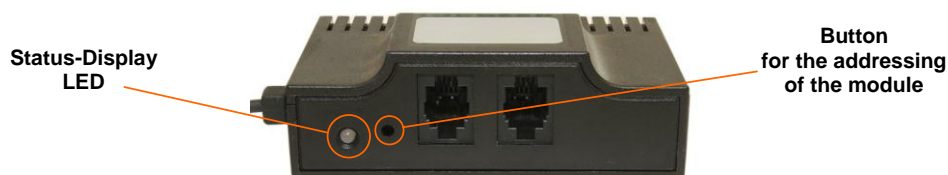

The moment the button is pressed, the red fast-flashing LED turns green and you hear a beep at your computer if you use the Windows EQUALINK Programmer tool. Every “beep” indicates that the next higher address (starting from “1”) has been successfully set. At the web-browser programming interface there will be no “beep”, but a green text message shows the successful addressing procedure (see below).



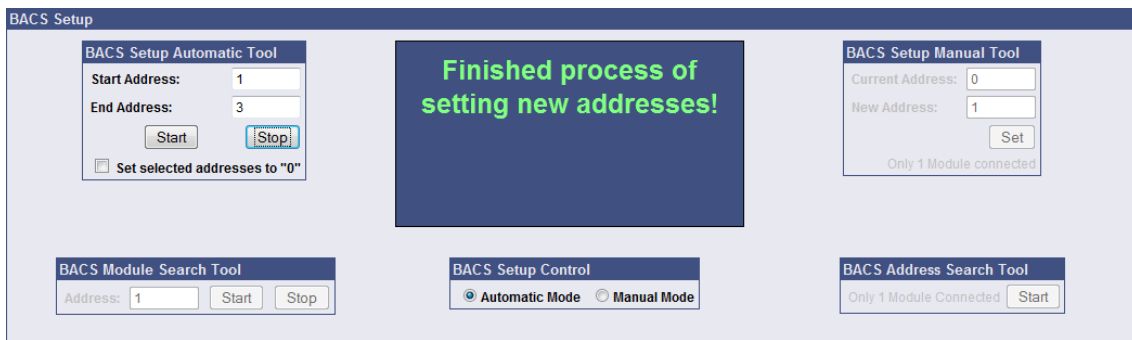

Figure 27: EQUALINK Web-Browser Programming Interface - Finished Addressing Process

Continue now with the next module, which becomes addressed now as no. 2. Continue this process until the last module has been addressed.

Finally click STOP to tell the system that the addressing mode is finished.

All modules should show a green static LED now. Congratulations! You have successfully addressed all your EQUALINK modules!

**Tip: Automatic Mode Partial Addressing**

Due to installation reasons, you may want to address your EQUALINK modules step-by-step, e.g. addressing number 1 to 32, then later from 33 to 64. If an error occurs at the automatic addressing, a message with the associated address will appear. It is required to restart the addressing from the address number where the error occurred, or use the manual mode to correct the address.

**FINISH:** Execute the "Save, Exit & Reboot" function into the "Save Configuration" menu now, to start the first time with EQUALINK measuring.

## 4. Quickstart - Starting EQUALINK the first time

After having started EQUALINK the first time, you will first see the start-up screen.

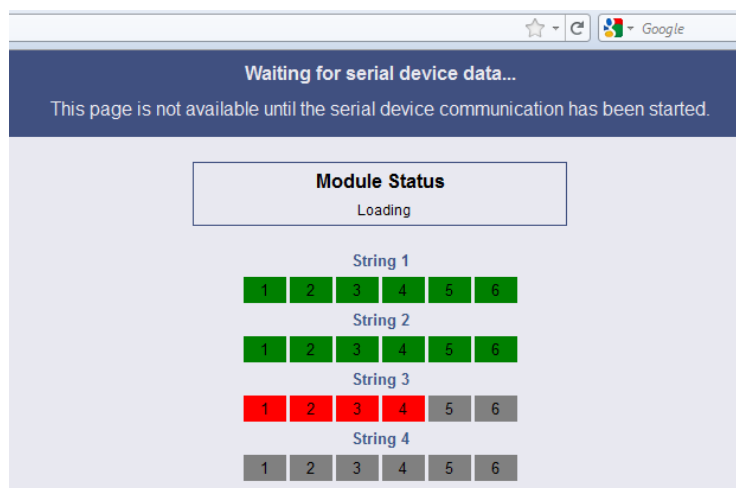

Figure 28: EQUALINK Start-Up Screen (64 Modules)

The colors have the following meanings:

- Green: EQUALINK module initialized = status okay
- Red: EQUALINK module not reachable
- Grey: EQUALINK module not polled/initialized yet

If EQUALINK has initialized all modules successfully, you will see the EQUALINK status page, with Voltage and temperature of the batteries, equalization/balancing power and the status LED. After 15 minutes the first measuring results of impedance are made. Please wait until the first RI measurement is visible before you continue with **Chapter 4.3 “EQUALINK Module & Alarm Threshold Setting”**.

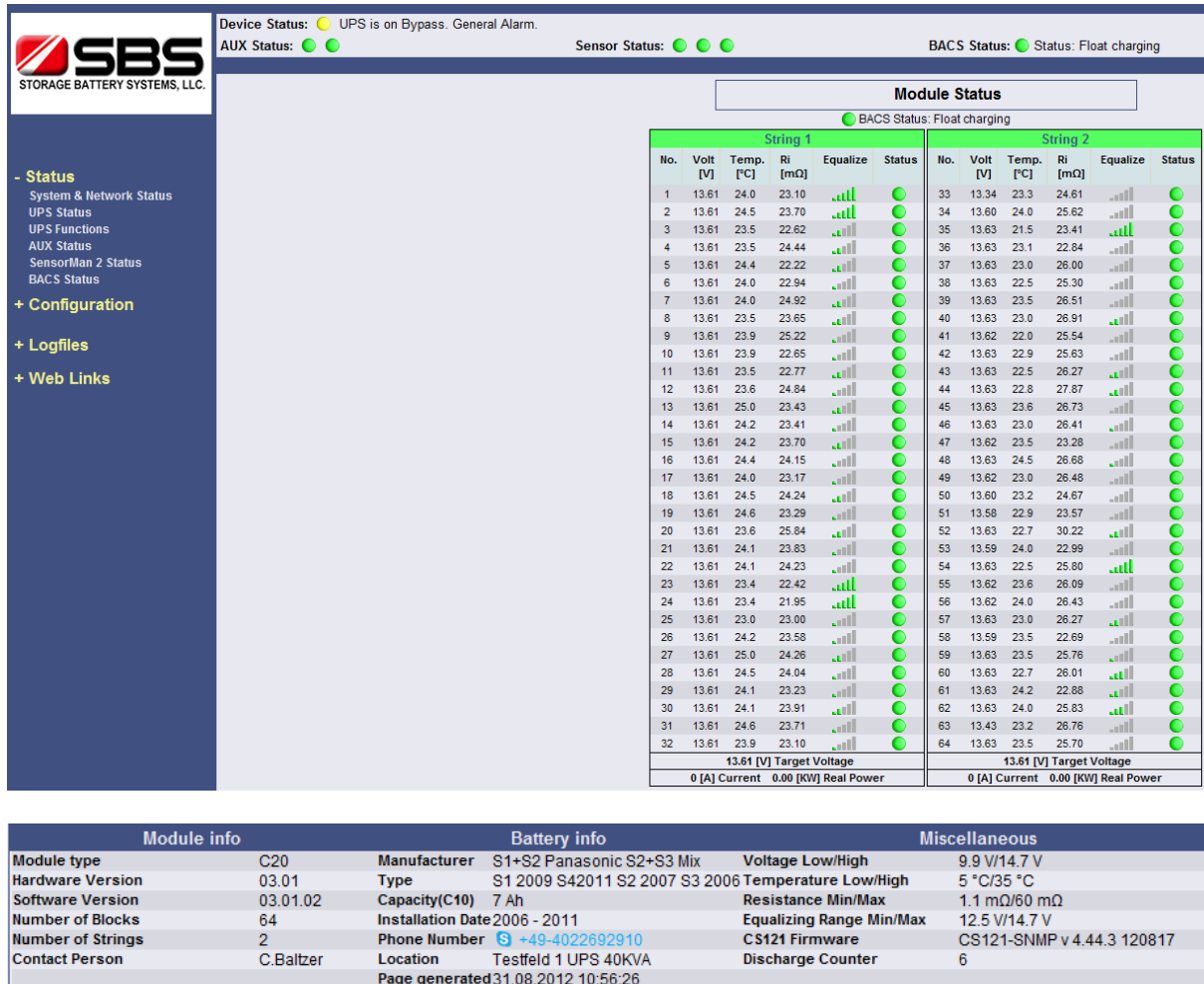

Figure 29: Web-browser EQUALINK Status Page (64 Modules)

**End of the EQUALINK QUICKSTART. For further configuration description and complete information on how to use the EQUALINK system, please use the complete EQUALINK User Manual and its FAQs.**

The EQUALINK Programmer Software is Windows Software, which uses all available functions of the EQUALINK Webmanager for the programming of the EQUALINK modules. If you want to pre-address the EQUALINK modules prior of the installation at customer site, you can use this software and an EQUALINK BUS CONVERTER 3.

**Contact SBS to get the “Netfinder” Software, which will scan your network environment:**

**(262) 703-5800 or email: [Test@SBSBattery.com](mailto:Test@SBSBattery.com)**

#### 4.1 (Optional) Using the EQUALINK SETUP Page in Manual Mode

Skip this step if you have already addressed your EQUALINK modules using the automatic mode and continue with chapter 4.2. *EQUALINK Module & Alarm Threshold Settings*

##### EQUALINK SETUP Manual Mode

The “Manual Mode” is for individual addressing of single modules or to correct or alternate addresses at maintenance.

### EQUALINK Module Search Tool

Identification of already addressed EQUALINK modules: You can search in your EQUALINK system for a single module via the menu **EQUALINK Module Search Tool**. The module will identify itself with a flashing red/green LED. Press the addressing button at the module to confirm that you have identified the module; it will now fall back into the normal operating mode. Optionally you may click on the STOP button to make the module fall back into normal operating mode.



**ATTENTION!** If you press this button for more than 2 seconds, the module will cancel the addressing mode and will be back into the delivery condition with address 0!

If the addressing button is pressed for more than 12 seconds into normal operation, the module will be reset to address 0 and the measuring and regulation function will be switched off, too. Therefore, new addressing of the module will be required.

### EQUALINK Module Setup Manual Tool

You can set or alter a single address in the **Manual Mode**. Enter the appropriate address into "Current Address" and enter the new, desired address into "New Address". Click the "Set" button to apply your settings. The new address of the module will be displayed in the programmer tool.



**ATTENTION!** Only one module should be connected at the bus if you use in the Manual Mode the Address Change functions! Disconnect all other EQUALINK modules from the EQUALINK Bus cable except the one you want to change! Otherwise you risk creating the same address for more than one module.

### EQUALINK Address Search Tool

With the EQUALINK Address Search Tool you can ask the EQUALINK module for its address. In case you find an EQUALINK module which is programmed (Green LED) but does not answer – you may connect this module to the EQUALINK bus and disconnect all other modules. Now click on START to request the module's address. After you know this address, you may use the EQUALINK Setup Manual Tool to alter this address.



**ATTENTION!** If are in Manual Mode, disconnect all other EQUALINK modules from the EQUALINK Bus cable except the one you want to change! Otherwise you risk creating the same address for more than one module.

### NOTE: Force to switch EQUALINK Modules to addressing mode

If the modules do not start fast red flashing (addressing mode), you can force this mode by pressing the addressing button for 12 seconds. This will force the module to go into the addressing mode and the LED will flash fast red. Restart now the Automatic Mode or Manual Mode to set the address number.

### Status LED-Display at the Module

Operating State of the Module	LED-Display
Not addressed (delivery status)	Slow red flashing
"Programming Mode" active	Fast red flashing
Addressed & communication = <b>Normal condition</b>	Green constantly
Addressed & actually no communication, no measuring	Green flashing
Out of threshold range, see web-browser, which alarm is actually present	Red constantly
Identification mode	Red/green flashing

After any change on the EQUALINK configuration do not forget to disable the configuration page and after this click in the “Save Configuration” menu the button “Save, Exit & Reboot” button and wait for about 3 minutes to restart. As soon as the green LED of the EQUALINK WEBMANAGER is slowly flashing the device is back and ready to continue configurations or monitoring.

## 4.2 (Optional) Set selected addresses to 0

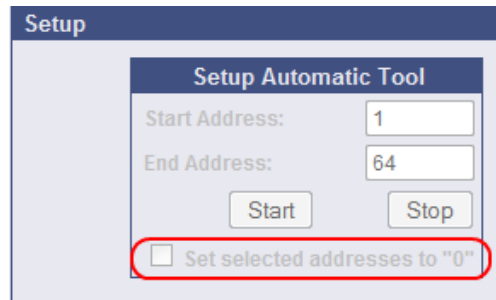

Figure 30: Reset to Factory Settings

If you enable this function, the EQUALINK System will reset ALL addresses to the default address “0”. This may be useful if you find a system that is not correctly addressed or if you want to setup a new set of batteries. Through this function the modules will be reset to the factory settings. The modules will display the address 0 through red slow flashing. Click on STOP as soon as all your modules flash slowly red and start addressing again.

## 4.3 EQUALINK Module & Alarm Threshold Settings

### 4.3.1 Configuration of EQUALINK Module & Alarm Threshold

Enter the alarm thresholds for your system in the menu “EQUALINK Module & Alarm Settings”. Alarm thresholds may be requested from your battery manufacturer or you may define the alarm levels yourself.

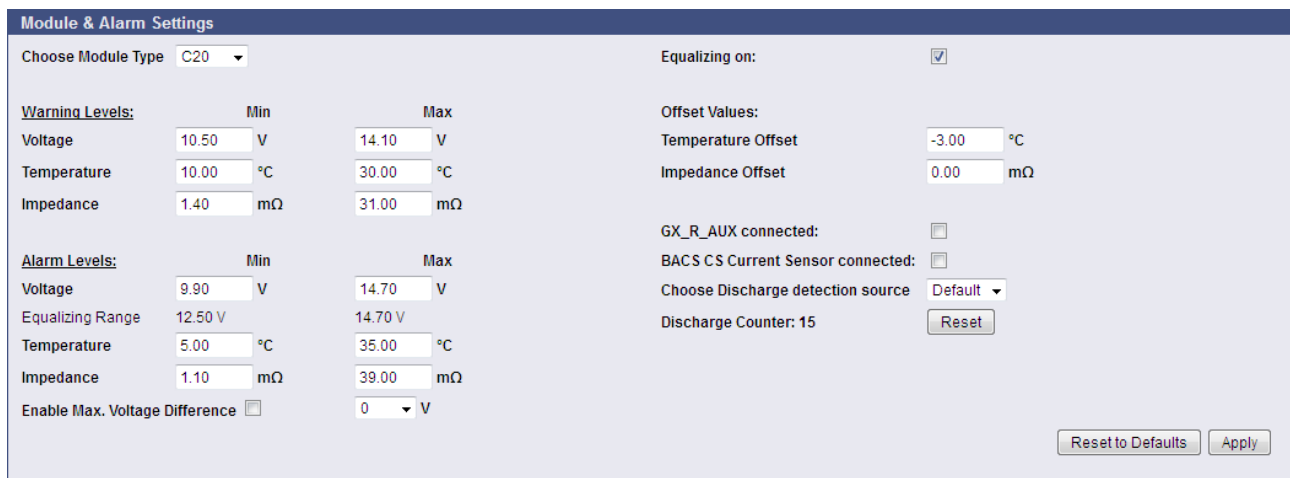

Figure 31: EQUALINK Module & Alarm Settings

### EQUALINK thresholds distinguish between “Warnings” and “Alarms”.

**Warnings:** At warning the EQUALINK Status LED in the Web-browser changes from green to orange. An Email is triggered if “Email on all event” function is enabled. NO SNMP Traps will be implemented at this stage, but the EVENT type “Warning” is triggered.

**Alarms:** At alarms the EQUALINK Status LED in the Web-browser changes from green/orange to red. An Email is triggered if the “Email on all event” function is enabled. The alarm buzzer and contacts are activated. Alarms also automatically transmit SNMP Traps (if configured) and execute all EVENT types “Alarm”. Alarms are set to the user’s thresholds, so the user defines if any alarm requires immediate reaction and correction of the alarm causing event – or if just the thresholds have to be altered.

- **Voltage Min.:** Voltage lower limit; if the voltage passes this value an alarm/warning will be triggered.
- **Voltage Max.:** Voltage upper limit; if the voltage passes this value an alarm/warning will be triggered.

- **Balancing Range:** displays the voltage window in which Balancing is active. Beyond this range (if too high) there will be an Alarm triggered and Balancing will automatically switch off. Below the window, Balancing will not start since there is not yet enough charging current available to distribute. By changing the limits for Voltage Alarm thresholds, this window can be altered. Please note that for standard lead-calcium batteries the default settings are ideal.
- **Temperature Min.:** Temperature lower limit; if the temperature passes this value an alarm/warning will be triggered.
- **Temperature Max.:** Temperature upper limit; if the temperature passes this value an alarm/warning will be triggered.
- **EQUALINK impedance alarm threshold:** Value of the impedance: if exceeded an alarm/warning will be triggered.
- **Enable Max. Voltage Difference:** You can define a difference value (0 – 1) by yourself. If the value will be exceeded, a “EQUALINK Voltage Difference Alarm” will be triggered.
- **Equalization/Balancing on:** Switching the Balancing function on / off.
- **EQUALINK CS Current Sensor connected:** Switching on / off of the optional EQUALINK current sensor logging.
- **Choose Discharge detection source:** You can select a source, which should be used as discharge detector (default = voltage drop, (slow detection)). If you select “UPS” or “BACS\_CS CurrentSensor”, the detection will be faster and will deliver more accurate values for the logging into the BACS Viewer.
- **Discharge Counter:** It is a simple counter for the amount of discharges since the installation of the firmware. It is a pure statistical function. The EQUALINK Viewer can display accurately, where a discharge was and where just a minimal voltage drop occurred.



Additional Information: Please note the following advice for the determination of the thresholds:

- **Voltage thresholds:** Voltage differences will be balanced within 24 hours, if EQUALIZATION/BALANCING is enabled. If the voltages still keep differing more than 0.50 Volt after 14 days, although Equalization/balancing is active with 100%, then the cause may be a faulty battery and should be checked.
- **Temperature thresholds:** The ideal temperature range for lead batteries is between 20°C to 25°C. Temperatures below 20°C are admissible, although it should not become less than 5°C below 20°C permanently. The lower threshold of the temperature is set per default to 10°C. In contrast, the upper value should be set so that an alarm or warning is given if the batteries get too hot. Batteries tend to grow warm during the charging and discharging process, the temperature range should be set higher than the expected normal room temperature to avoid false alarms. Normally the temperature of a battery rises about 10°C during discharging/charging. That means at a normal temperature of 20°C, the alarm threshold should be set at 30°C. Increasing to 35°C over a long period of time could damage the battery and should be monitored. Additionally, if the higher temperature after the charging or discharging process does not return to a normal value within 10 to 15 hours, a defect may be present in your battery system (charger or battery problem). After any alarm, double check the measured values manually before taking any action. Do not tolerate high temperature alarms over longer periods; this could also be a warning of a dangerous “thermal runaway” effect of corrupted batteries which could end in a fire.
- **Internal resistance:** Ideally the measurement values of the internal resistance of new batteries should be within a short range of each other and should not differ more than 20% from the average impedance of all batteries. Example: If you can see that the majority of your batteries are at e.g. 15mOhm (example for a small 7Ah battery), than the accepted tolerance should be max. +/- 20%, which is 17 – 23 mOhm). The alarm threshold should be set at + 30% of the upper accepted limit – which results in this example at 29.9 mOhm as Warning Threshold.

Batteries of the same age and the same type that show impedance varying more than 20% should be checked. To make sure that it is not a measuring problem, check measuring cable to verify it is firmly connected to the EQUALINK module. To prove if the EQUALINK module is the source of problem, please change with any other, correct measuring module to see if the results change or not. If this check also shows no problem at the Measuring components, the problem is the battery or the battery connectors!



**NOTE:** Please wait at least 15 minutes after EQUALINK has been started before you continue to set the alarm levels for Impedance. The EQUALINK system starts measuring impedance the first time 15 minutes after reboot. Another 3 measurements are taken within the following 45 minutes to precisely verify the first measurements. After 60 minutes the system re-measures impedance every 24 hours. So we recommend you start to set the RI thresholds 60 minutes after the EQUALINK WEBMANAGER has booted to avoid false alarms because of the correcting of the measurement during the first 60 minutes.

After having defined the warning and alarm thresholds, press the APPLY button to confirm your settings. Restart the WEBMANAGER, click the “Save Configuration” button and click the “Save, Exit & Reboot” button and wait until the device has rebooted and shows the first measurement. If all your measurements are now within the defined limits your *EQUALINK Module & Alarm Threshold Settings* are finished and your system is ready for use.

Chapter 5 explains the display and history log files of the EQUALINK system. Chapter 5 is for the end-user or the battery service company.

### 4.3.2 Configuration of EQUALINK Offset Values

In this configuration you can adjust the measuring of the EQUALINK system to your calibrated handheld measuring device. With negative or positive values for temperature and impedance you can now setup the EQUALINK system to correspond to your reference system, for an easier overview and comparison of manually created reports.

**Impedance Offset:** Change EQUALINK measuring to your reference RI measuring device. E.g. by -2.2 you would deduct 2.2 milliohm from the real EQUALINK RI measuring on all EQUALINK modules. A positive value would add this offset to all EQUALINK modules and show a higher value than the EQUALINK raw data. Please note that such offsets should be noted in your battery reports.

**Temperature Offset:** Change EQUALINK measuring to your reference thermometer. E.g. by +2.0 you would add 2°C to the real EQUALINK temperature measuring on all EQUALINK modules. A negative value would deduct this offset to all EQUALINK modules and shows a 2°C lower temperature than the raw data. Please note that such offsets should be noted in your battery reports.

## 5. Monitoring with EQUALINK

### 5.1 Monitoring with EQUALINK STATUS PAGE

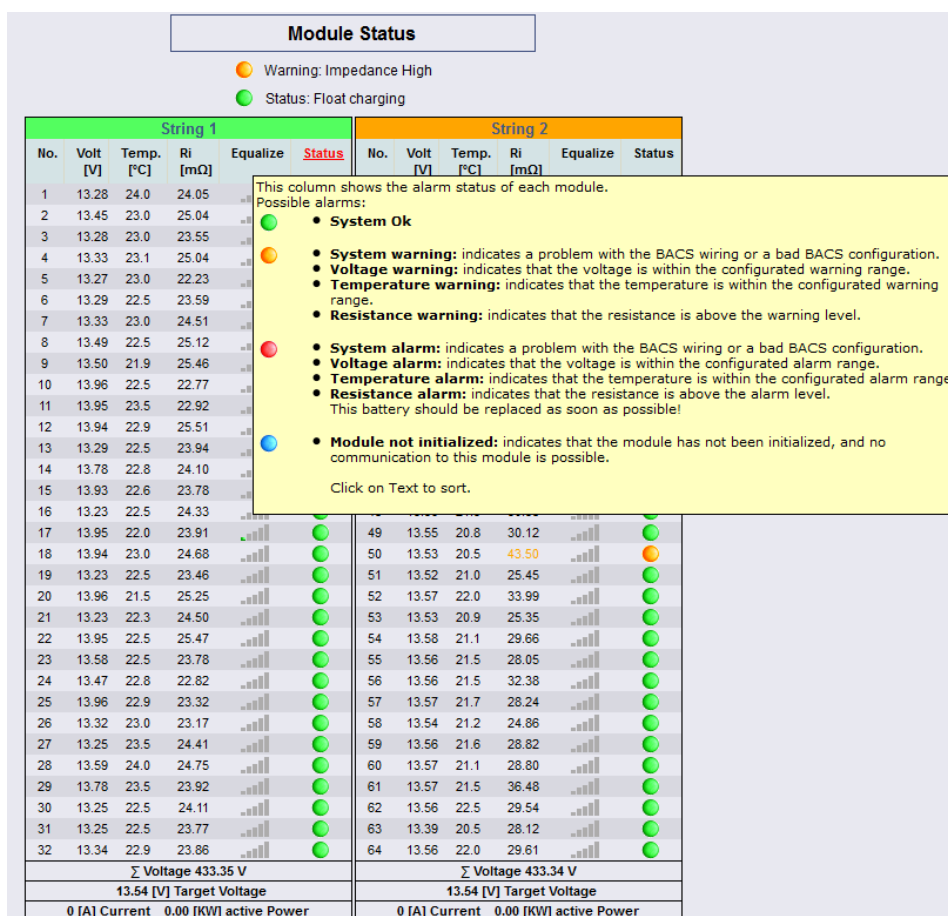

Figure 32: Web-Browser EQUALINK Status Page Showing Balancing Activity



**Note:** The EQUALINK WEBMANAGER firmware version 4.40.x or higher displays if EQUALIZATION/BALANCING is active or not. A gray LED means that the BALANCING is 0%, but ready and will take action, as soon as the voltages drift apart.

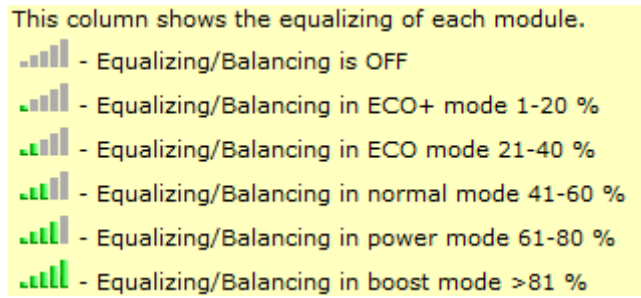

Figure 33: Web-Browser EQUALINK Status Page Showing Balancing Activity per Module

Move the mouse pointer over the gray-green bars to display the exact Balancing power.

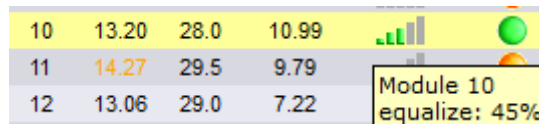

Figure 34: Web-Browser EQUALINK Status Page Showing Equalization/Balancing Activity Display per Module

The monitoring of the actual battery system and environmental data is made through any web-browser and email server and/or RCCMD clients for alarms and warnings. The graphic above shows such a display, here the EQUALINK STATUS page and the overall STATUS of other connected devices is displayed in the header. To switch between the EQUALINK, UPS and other status pages, click on the Status LED to display the other STATUS pages, e.g. for UPS, environmental sensors and alarm contacts. To change the default “welcome screen” from EQUALINK STATUS page to any other STATUS page, please change this in the “Network & Security” configuration of the EQUALINK WEBMANAGER.

### The EQUALINK STATUS page

All important data for every single battery is displayed on the web-interface status page. The module-number of the accordant module is displayed in the 1<sup>st</sup> column. You can select the numbering (consecutive or string-wise from 1 –n) for the strings in the “EQUALINK Configuration” menu.

The module voltage is displayed in the 2<sup>nd</sup> column. By activated Balancing, at constant charging, all module voltages should be identical, between 1 day to 2 days. The acceptable level is a difference of max. 0.5 Volts at a 12 Volt battery. If this is not achieved after 1-2 weeks, sulphation may be the cause. Do a discharge of the batteries to see if the impedance goes down and the batteries have a chance to get equalization/balancing during the following recharge process. If this does not have the intended effect and the batteries keep showing a difference of more than 0.5 Volt during supply charge, please contact your battery service company to check the batteries or the charger. You can define the difference value into the EQUALINK firmware that you want to tolerate. If this value will be exceeded, an “EQUALINK Difference Voltage Alarm” will be triggered, which can be defined from 0.05 to 1V.

The temperature of the external EQUALINK modules is displayed in the 3<sup>rd</sup> column in degrees of Celsius. The temperature of every single battery will be monitored and logged.

The internal resistance of every single battery is displayed in the 4th column. Changes in the value of more than 30% from the average settings need investigation; please check the battery concerned or the module and the measuring cable.

**Note:** From the EQUALINK WEBMANAGER firmware version 4.38.x or higher the RI measurement will take place step-by-step, after 15 minutes the EQUALINK Modules will be polled individually, with interruptions of 30 to 50 seconds between the EQUALINK Modules.

If the equalization/balancing function is activated, it is displayed in the 5th column the actual Balancing level is in % of the total available Balancing power. When the module uses less than 50% of the available Balancing power, this LED turns dark green. If the value is higher than 50%, the equalizing LED turns to lime green. This green light does not show that the batteries are in good shape, it just shows that the Balancing process is active and actually runs at more than 50%. The longer EQUALINK is installed, the less Balancing should be needed. If all batteries show identical voltages and Balancing is dark green on all modules, then you know that only little corrections are needed to keep the batteries in the optimal voltage range.

Alarm and Warnings are shown in the 6<sup>th</sup> column, called "State".

- **Green:** The battery is OK, within of the configured thresholds.
- **Orange:** At least one measuring value reached a warning level, but did not pass the alarm thresholds.
- **Red:** The internal resistance, the temperature, or the voltage passed the defined thresholds or the communication of the accordant module is actually not active. In addition a "SYSTEM ALARM" will be displayed in red, if one or more EQUALINK modules are not working properly. This means that NO monitoring is happening and you have to resolve it immediately. System alarms are delayed to decrease false alarms. Example 1: If the connection to one EQUALINK module (nr. 24, cable disconnected) is lost, it will last 4 minutes until the system alarm is displayed on the web-interface. The alarm contact will be delayed for another 90 seconds. Example 2: If the connection is lost to all EQUALINK modules (bus cable at the EQUALINK WEBMANAGER disconnected), it will last approx. 35 minutes until the first EQUALINK modules will alert a system alarm. The alarm contact will be delayed triggered for further 90 seconds.
- **Blue:** No communication to the EQUALINK module, system is not ready. The module was not found during start up or a configuration error is existent.

**Advice:** We recommend recording the EQUALINK history files for a periodic inspection, to monitor the behavior of the measured values. Do a screenshot of the EQUALINK status page from time to time and store these for later inspections. Repeat this process about every 3 months. We also recommend retrieving the EQUALINK log files using the EQUALINK Viewer Software on a regular basis and forward this information to your battery service company for interpretation of the data.

The EQUALINK STATUS page is refreshed on a regular basis. To find easily the highest and lowest values, you may click on the blue header text of every column, to sort the values from high to low or the other way round.



**Advice:** From EQUALINK WEBMANAGER FirmWare Version 4.35.x: The EQUALINK status was extended: "Target Voltage" will be displayed, if EQUALIZATION/BALANCING is *active*. The EQUALINK modules indicate which value of the voltage is desired. "Average Voltage" will be displayed, if EQUALIZATION/BALANCING is *disabled*. Therefore the latest averaged voltage will be displayed.



String 1						String 2					
No.	Volt [V]	Temp. [°C]	Ri [mΩ]	Equalize	Status	No.	Volt [V]	Temp. [°C]	Ri [mΩ]	Equalize	Status
1	13.26	24.0	24.05	█	●	33	13.27	22.5	41.63	█	●
2	13.40	23.3	25.04	█	●	34	13.53	23.0	44.02	█	●
3	13.27	23.1	23.55	█	●	35	13.58	22.0	25.53	█	●
4	13.33	23.1	25.04	█	●	36	13.56	21.5	26.84	█	●
5	13.25	22.8	22.23	█	●	37	13.55	22.0	34.89	█	●
6	13.29	22.7	23.59	█	●	38	13.55	22.0	29.77	█	●
7	13.33	22.8	24.51	█	●	39	13.56	22.2	31.80	█	●
8	13.55	22.5	25.12	█	●	40	13.57	22.2	30.64	█	●
9	13.83	21.9	25.46	█	●	41	13.55	21.3	28.54	█	●
10	13.92	22.5	22.77	█	●	42	13.56	22.0	32.01	█	●
11	13.92	23.5	22.92	█	●	43	13.56	21.0	29.26	█	●
12	13.90	23.0	25.51	█	●	44	13.56	22.0	39.98	█	●
13	13.29	22.5	23.94	█	●	45	13.56	21.9	30.26	█	●
14	13.92	22.9	24.10	█	●	46	13.56	22.5	29.37	█	●
15	13.92	22.9	23.78	█	●	47	13.54	21.1	25.58	█	●
16	13.20	22.5	24.33	█	●	48	13.56	21.5	30.38	█	●
17	13.92	22.0	23.91	█	●	49	13.55	21.0	30.12	█	●
18	13.91	23.0	24.68	█	●	50	13.53	20.5	43.50	█	●
19	13.22	22.5	23.46	█	●	51	13.52	21.2	25.45	█	●
20	13.92	21.5	25.25	█	●	52	13.57	22.0	33.99	█	●
21	13.22	22.5	24.50	█	●	53	13.53	21.0	25.35	█	●
22	13.92	22.5	25.47	█	●	54	13.58	21.5	29.66	█	●
23	13.54	22.5	23.78	█	●	55	13.55	21.5	28.05	█	●
24	13.45	22.8	22.82	█	●	56	13.55	21.5	32.38	█	●
25	13.92	22.9	23.32	█	●	57	13.57	21.6	28.24	█	●
26	13.35	23.0	23.17	█	●	58	13.54	21.3	24.86	█	●
27	13.25	23.5	24.41	█	●	59	13.56	21.5	28.82	█	●
28	13.56	24.0	24.75	█	●	60	13.57	21.2	28.80	█	●
29	13.76	23.5	23.92	█	●	61	13.57	21.5	36.48	█	●
30	13.23	22.7	24.11	█	●	62	13.56	22.5	29.54	█	●
31	13.25	22.5	23.77	█	●	63	13.39	20.5	28.12	█	●
32	13.35	22.7	23.86	█	●	64	13.56	22.0	29.61	█	●
Σ Voltage 433.35 V						Σ Voltage 433.32 V					
13.54 [V] Target Voltage						13.54 [V] Target Voltage					
0 [A] Current 0.00 [KW] active Power						0 [A] Current 0.00 [KW] active Power					

Figure 35: Sort function – Sort Web-browser EQUALINK Status Page by Voltage, Temperature or Impedance

**i** Note: From EQUALINK WEBMANAGER firmware version 4.35.x an error message will be displayed, if EQUALINK modules with REV 2.2 and REV 3.0 were mixed into the bus. A mix of different EQUALINK hardware revisions is not possible and EQUALINK does not start. From EQUALINK WEBMANAGER firmware version 4.42.x the sum voltage will be displayed too.

Module Status						
<ul style="list-style-type: none"> <li>● Alarm: General Alarm, Communication Lost</li> <li>● Status: Charging</li> <li>● Error: BACS type HW Revision mismatch or uninitialized modules</li> </ul>						
String 1						
No.	Volt [V]	Temp. [°C]	Ri [mΩ]	Equalize (ON)	Status	
1	13.81	27.6	n.a.	●	●	
2	13.66	26.2	n.a.	●	●	
3	13.82	27.0	n.a.	●	●	
4	n.a.	n.a.	n.a.	●	●	
5	n.a.	n.a.	n.a.	●	●	
6	n.a.	n.a.	n.a.	●	●	
13.77 [V] Target Voltage						
n.a. [A] Current						

Figure 36: EQUALINK Module HW Revision Mismatch

**i** Note: From EQUALINK WEBMANAGER firmware version 4.35.x the EQUALIZATION/BALANCING Min/Max range will be displayed. The Voltages of all Modules per String have to be within the limits before BALANCING will start to operate.

Module info		Battery info		Miscellaneous	
Module type	C20	Manufacturer	S1=Panasonic S2=mix	Voltage Low/High	9.9 V/14.7 V
Hardware Version	03.00	Type	AGM	Temperature Low/High	5 °C/40 °C
Software Version	03.00.22	Capacity(C10)	7 Ah	Resistance Min/Max	5 mΩ/42 mΩ
Number of Blocks	64	Installation Date	01.05.2009	Equalizing Range Min/Max	12.94 V/14.21 V
Number of Strings	2	Phone Number	+49-4022692910	CS121 Firmware	CS121-SNMP v 4.35.3 110809
Contact Person	C.Baltzer	Location	Q02 Testroom 1	Discharge Counter	0
		Page generated	12.08.2011 13:37:34		

Figure 37: EQUALINK Status – Further Information

## 5.2 Monitoring with EQUALINK AUX / Dry contacts

Every EQUALINK system provides an AUX interface where the Alarm Buzzer, LED and the Dry contact output can be configured for using such signals for third party alarm systems. The Default settings are shown below and may be adjusted to your external alarm system by the AUX Settings Webpage, “COM2 & AUX Settings”:

AUX Settings				
Port	Name	Usage	NC contact	
1	Buzzer On/Off	Output	<input type="checkbox"/>	
2	Alarm Contact	Output	<input checked="" type="checkbox"/>	

Write logfile entry on AUX output:

Figure 38: BUS CONVERTER Alarm Buzzer/Contact Configuration

## 6. Analysis of the Battery Data with EQUALINK Viewer

**Installation:** The EQUALINK Viewer is an easy-to-use tool for the monitoring and analyzing of the logged battery data provided by the EQUALINK Web manager. The EQUALINK Viewer runs on Windows software and is available for free:

**Contact SBS to get the software:**

**(262) 703-5800 or email: Test@SBSBattery.com**

**NOTE:** The data interpretation of the EQUALINK Viewer should be carried out by an experienced battery engineer. The decision if a battery can still be regarded as OK or should be exchanged requires a lot of experience and knowledge of the battery installation, its usage and environment. The EQUALINK Viewer shows a lot of information which you may use to make a decision, the EQUALINK VIEWER is a tool which is not liable if the interpretation of the data is made incorrectly. We strongly recommend using the EQUALINK VIEWER as additional tool for examining data, but the decisions for replacing or continuous usage of batteries should be made by experienced battery service engineers.

EQUALINK VIEWER is analyzing a very large amount of data, depending on the size and timescale of battery systems. For complex computing procedures we recommend you use a fast computer to avoid long response times.

### 6.1 Installation of the EQUALINK Viewer

Extract all files from the download ZIP file into any temporary folder on your Windows computer's hard disk. Start the installation by double clicking on “EquaLinkViewInstall.exe”. After the installation start the EQUALINK Viewer and add your EQUALINK WEBMANAGER's IP address to the list of EQUALINK Devices.

When you start the EQUALINK Viewer for the first time you have to create an entry for an EQUALINK system. EQUALINK Viewer is designed to analyze several EQUALINK installations, local or remote. To add the first EQUALINK installation for analysis, click the “New...” button to enter the device data of the EQUALINK system you want to setup. Enter IP address and a description and the password for accessing the EQUALINK WEBMANAGER. After this click on “OK” and “OPEN” this EQUALINK configuration the first time.

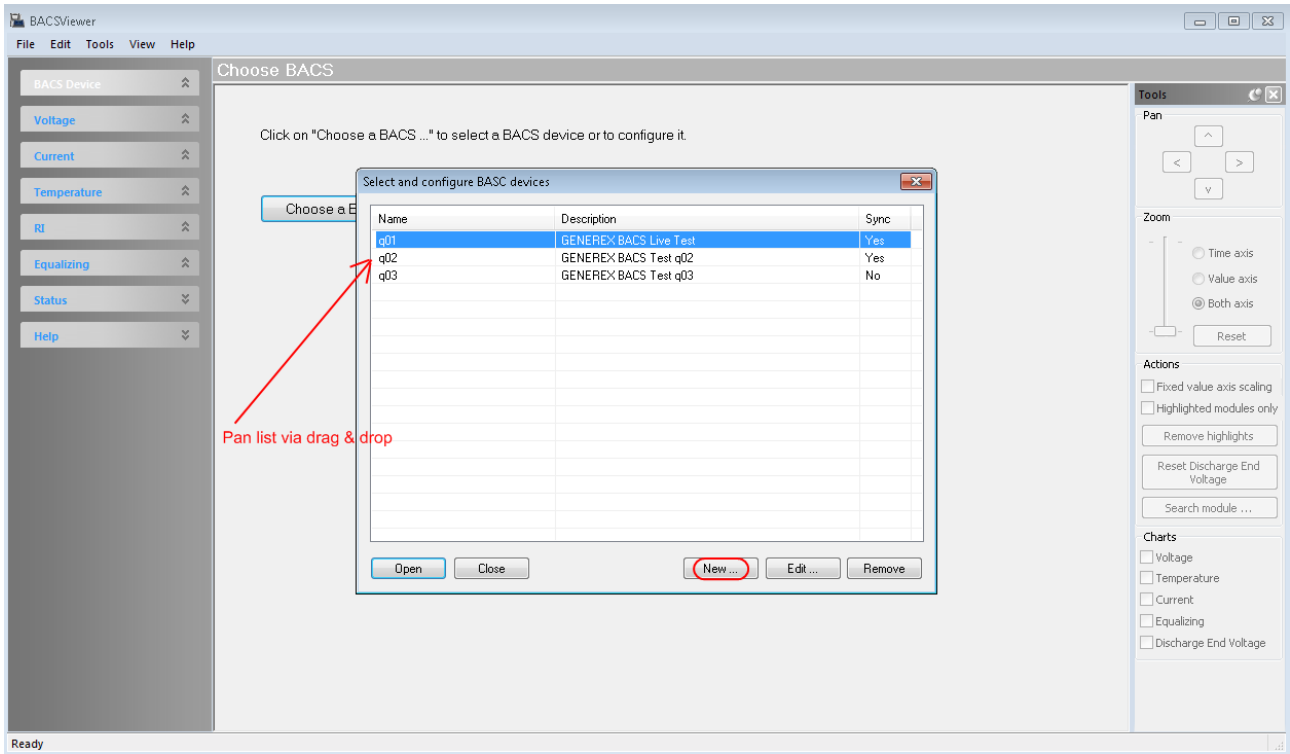

Figure 39: EQUALINK Selection/Configuration

At the start of the program for the first time, no data is found and you have to synchronize the database first – or import log files, e.g. with a USB stick or other media, if you do not have network connection to your EQUALINK WEBMANAGER (see chapter 6.5).

The EQUALINK Viewer version 4.1.0.0 provides the function of the pan of the list of the entries via drag & drop. If you select one device with "Open", the sequential arrangement will be saved; "Close" discards the changes.

## 6.2 Add EQUALINK Device, Autosynchronization of the EQUALINK Data

Add the IP address or the hostname of your EQUALINK WEBMANAGER to the list.

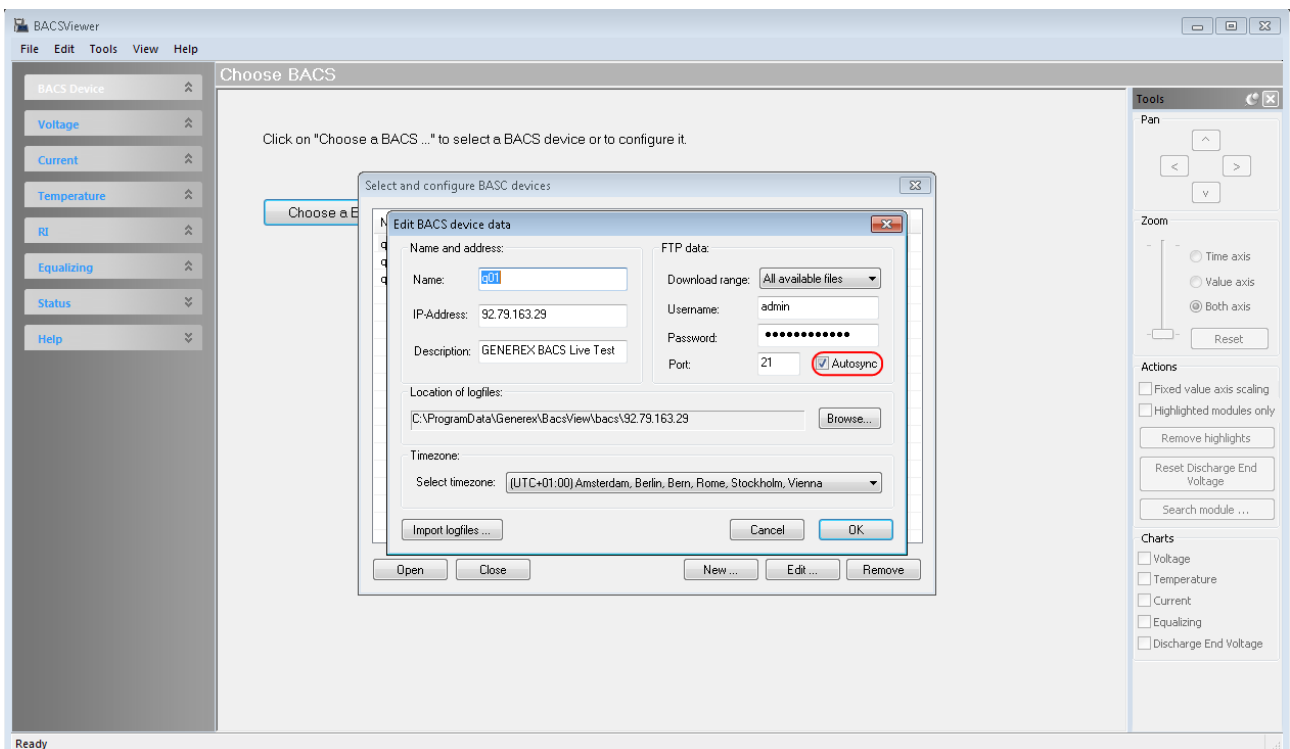

Figure 40: Add EQUALINK Device

The EQUALINK Viewer version 4.1.0.0 provides the option to enable the “Autosync” mode. You can define under “Edit, Settings, FTP”, if the autosync should be executed during program start.

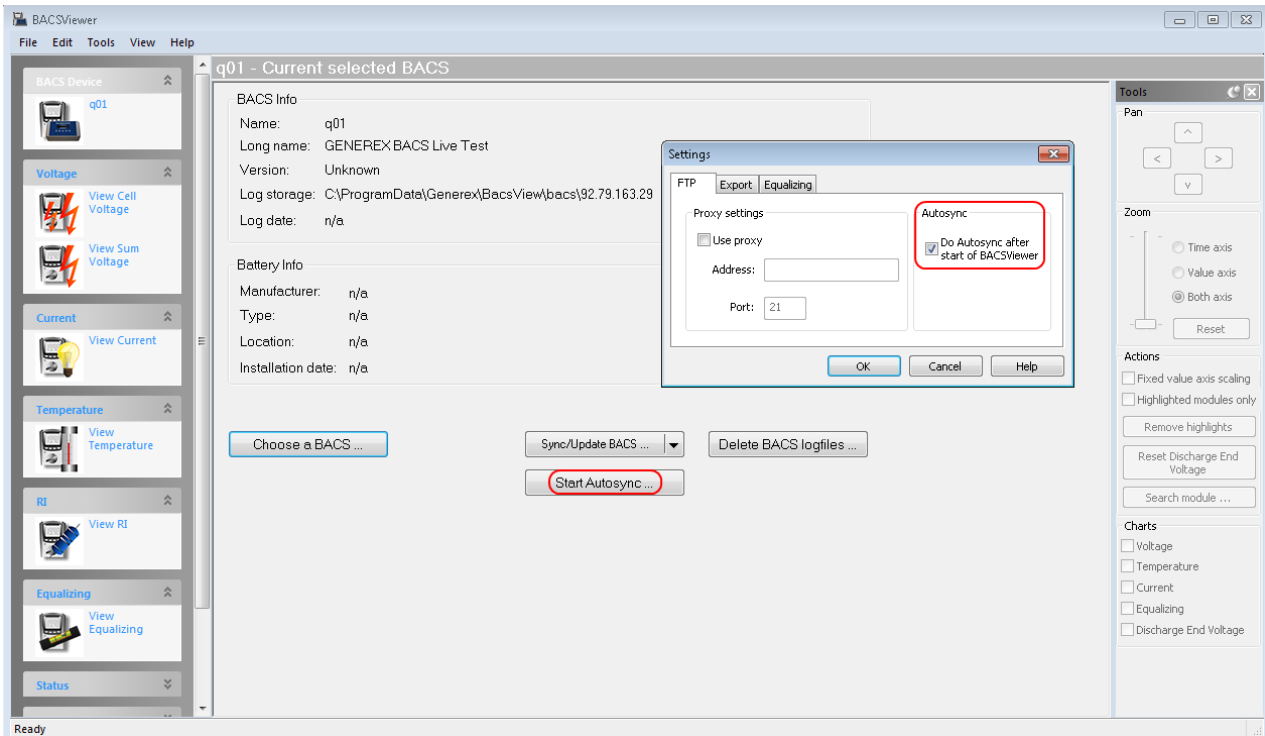

Figure 41: EQUALINK Settings, FTP

The EQUALINK-Info screen provides a button for the start of the Autosync manually.

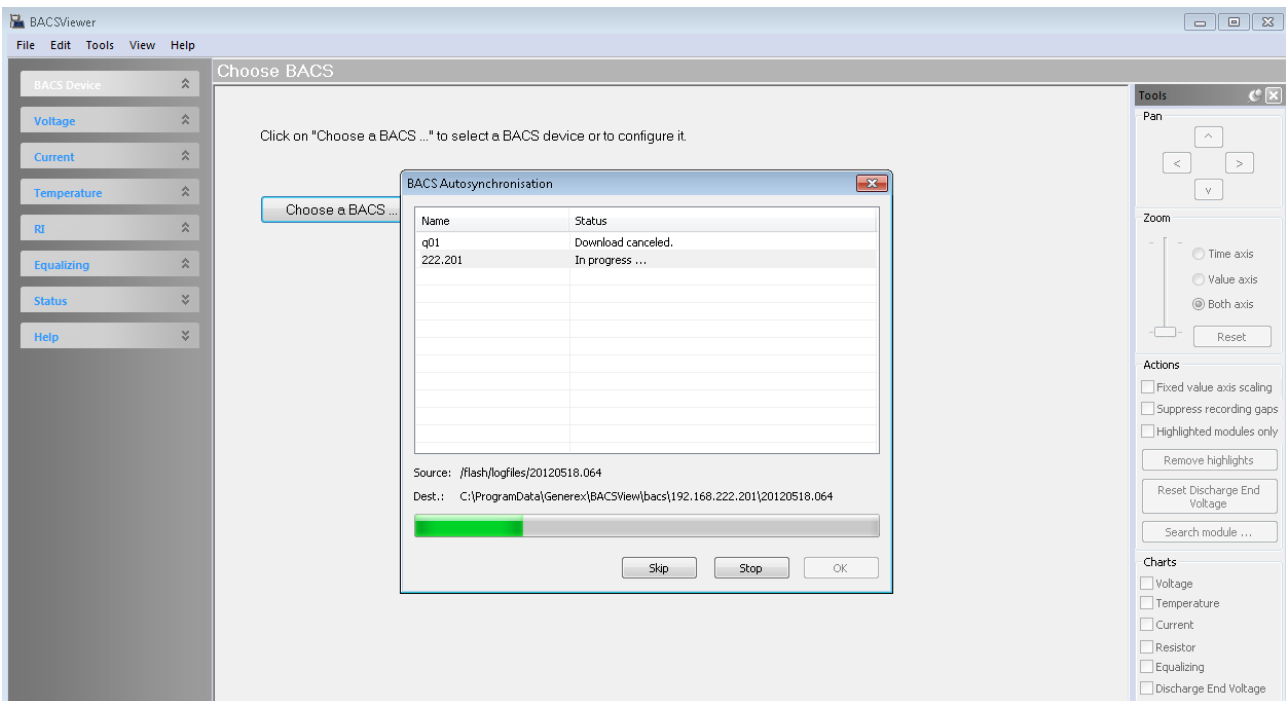

Figure 42: EQUALINK Autosynchronization

The EQUALINKViewer version 4.3.0.4 provides the feature to skip an already started autosynchronization process, if you do not want to synchronize the logfiles of this EQUALINK Webmanager. Click the “Skip” button.

You can see into the EQUALINK device selection, if the Autosync was configured for the devices.

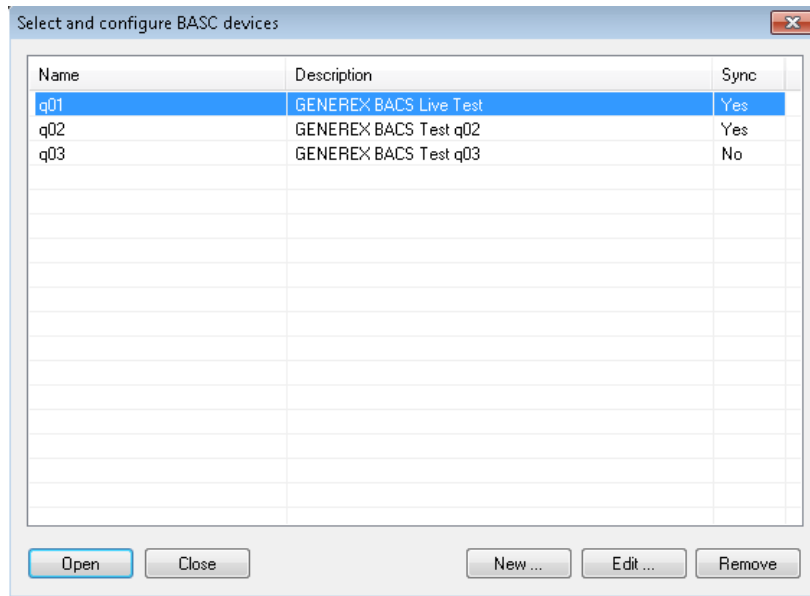

Figure 43: EQUALINK Device Selection Autosync Enabled

### 6.3 Synchronization of the EQUALINK Data Manually

Click the “Sync/Update EQUALINK...” button. The data of your EQUALINK device will be transferred via FTP.

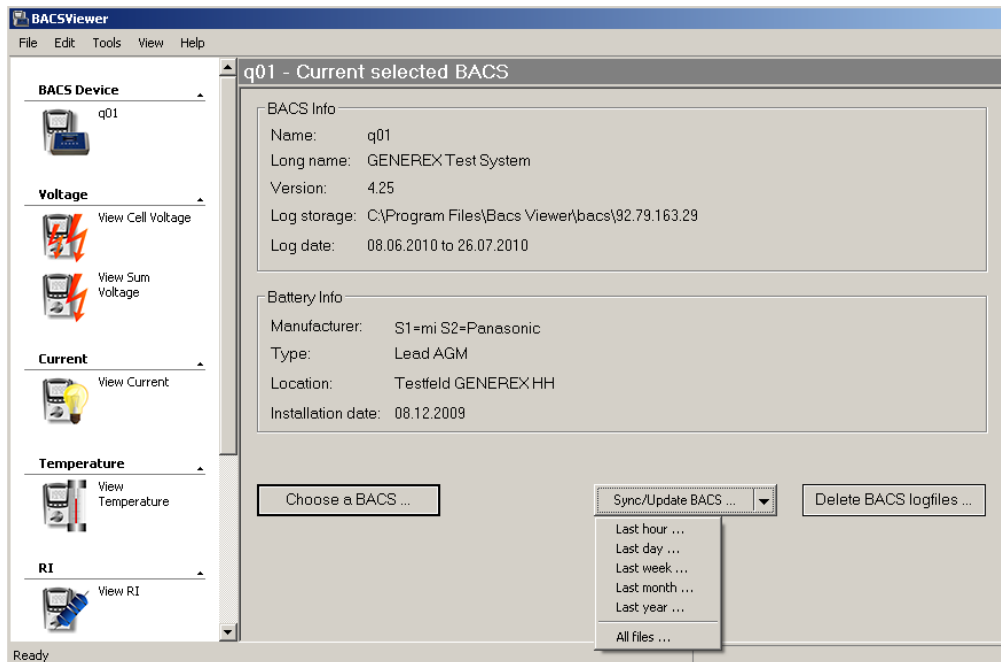
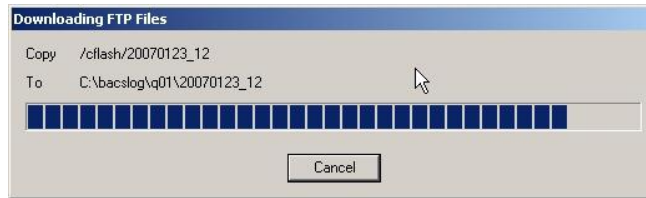

Figure 44: Synchronization of the EQUALINK Data

Click the “Sync/Update EQUALINK...” button if not already done before; the data will be transferred via FTP from your target EQUALINK system.

The progress of the FTP transfer will be displayed.



Alternatively you can import EQUALINK data, e.g. from a USB stick or another medium. The easiest way is the synchronization via ftp connection to the EQUALINK system you want to analyze.

During the synchronization you may limit the period of the download of the log files into the dropdown menu of the “Download range” is you are not interested in older data.

Please note that the EQUALINK WEBMANAGER has a limited storage capacity. We recommend that you delete from time to time the older EQUALINK data from the EQUALINK WEBMANAGER. Depending on the quantity of batteries and number of alarms, the EQUALINK system can store battery data for at least 3 months (at 256 batteries), up to several years if only a few batteries are monitored.

EQUALINK VIEWER offers you all configurations it has found on your EQUALINK system. If you find any unwanted configuration (e.g. 1 string, 1 module) please remove this configuration later from your EQUALINK system and this EQUALINK Viewer computer.

After the transmission is finished, you can start with the analysis of the data. Please see chapter 6.6 for further information.

## 6.4 Deleting EQUALINK data from EQUALINK Webmanager and Local Computer

You have the following options for the deleting of the log files via the “Delete EQUALINK log files” button:

- “Delete files from EQUALINK device” – Deleting of the files at the EQUALINK Web manager.
- “Delete files from local disk” – Deleting of the files at local hard disk.
- “Delete files of all configuration” – Deleting of the files of the entire configurations or the selected one.

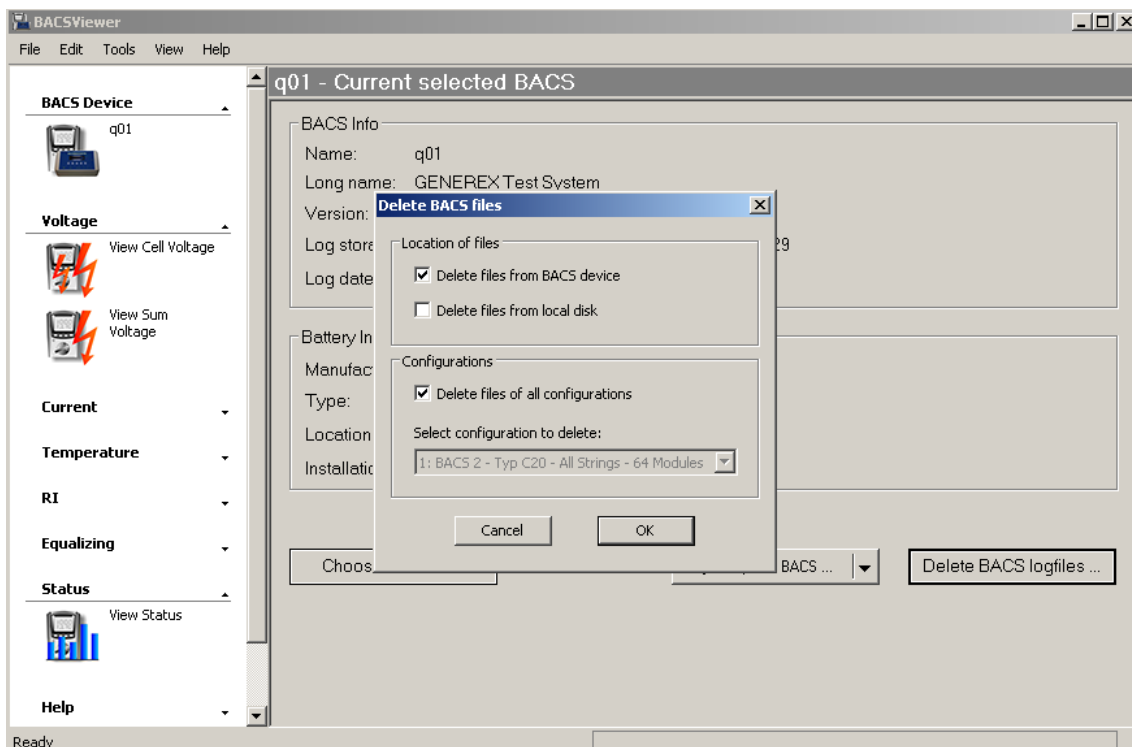

Figure 45: EQUALINK “Delete EQUALINK Files” Function

## 6.5 Import EQUALINK Data

You can import files from the local hard disk or USB stick via the “Import log files” button. Choose the relevant EQUALINK system and click the “Edit” button.

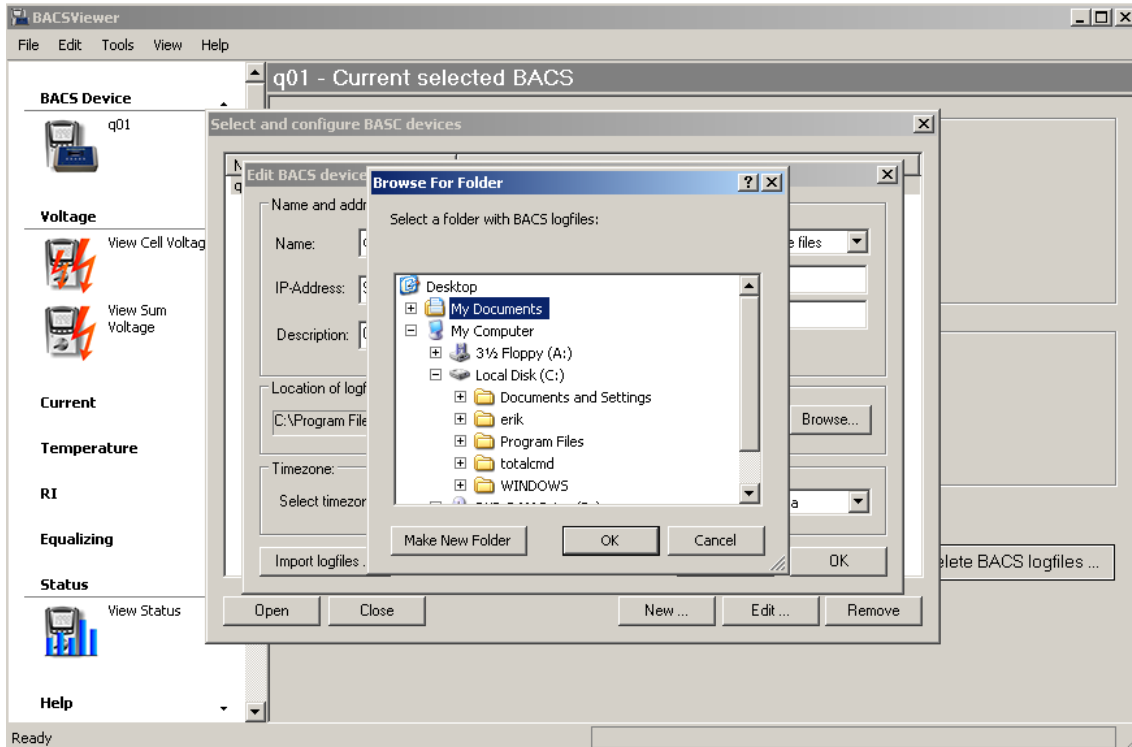

Figure 46: EQUALINK Import of Files

### Tip:

The transfer of the EQUALINK log files into your local directory can be started automatically by a script command. `EQUALINKView.exe -r <download_range_option> "<name of the device>"`  
This command will automatically download the latest EQUALINK files to your local directory. To link this command to your desktop, see the following screenshot:

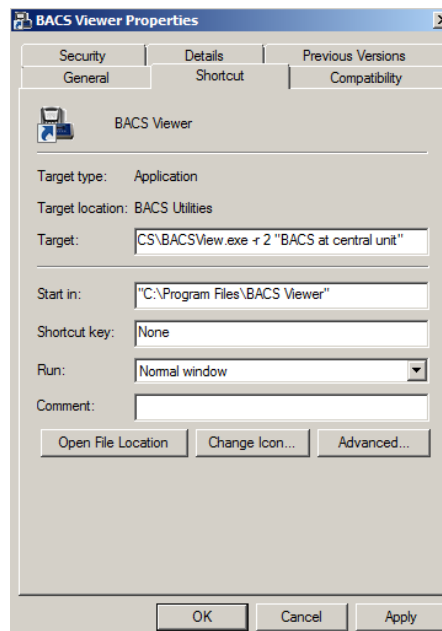

Figure 47: EQUALINK Viewer Script Parameters for the Automatic Download

## 6.6 Starting EQUALINK Data Analysis

Using the example of the voltage analysis we describe in chapter 6 the usage of the tools (zoom in, zoom out, pan etc.), after you have entered the network data of your first EQUALINK system, click the “Choose an EQUALINK...” button, to open the data on your local hard disk.



### 6.6.1 Voltage Analysis with the EQUALINK Viewer

Start with the voltage analysis (View Cell Voltage), since failures are easy to detect here and discharges are visible. Next, we describe the analysis of the impedance, temperature etc.

All described functions for the analysis of the voltages are present for the analysis of the temperature, current and internal resistance too.

Choose “All Strings” to see all battery data of all strings on one screen. For further investigations you may later choose only a special string number to reduce the amount of data displayed. “All Strings” is for a general survey of all data.

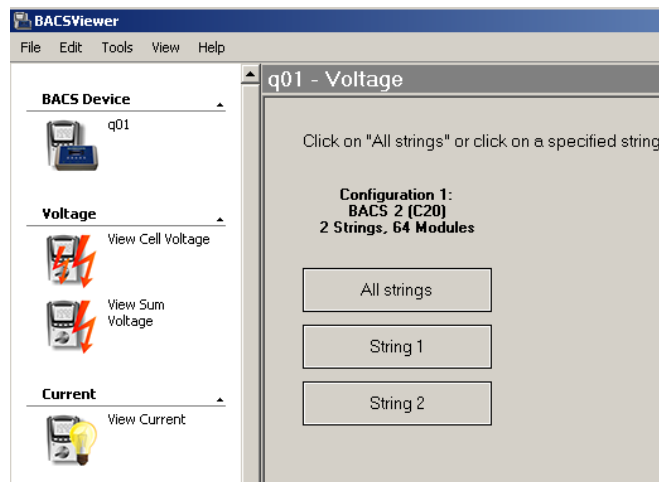

Figure 48: EQUALINK String Selection

“View Cell Voltage” was selected. At “Show all values” you will see all available data on one screen. You can define a time range or display only time period. Click the “Show chart...” button for the graphical display to open.



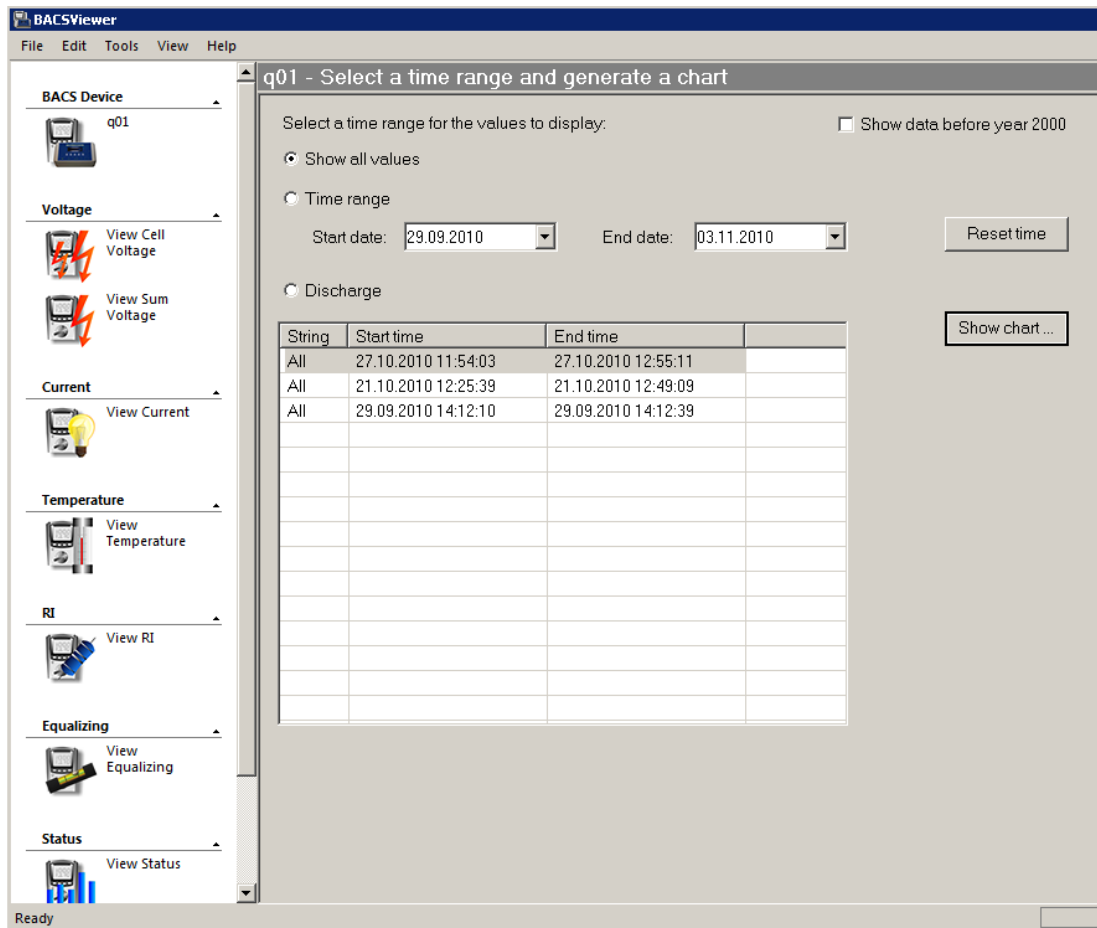

Figure 49: EQUALINK Time Range Selection

NOTE: The function "Show data before year 2000" is enabled by default. Any EQUALINK data with timestamps before year 2000 will automatically not displayed. If you do not have set a timeserver in your EQUALINK WEBMANAGER, than please disable this function to see EQUALINK data before year 2000.

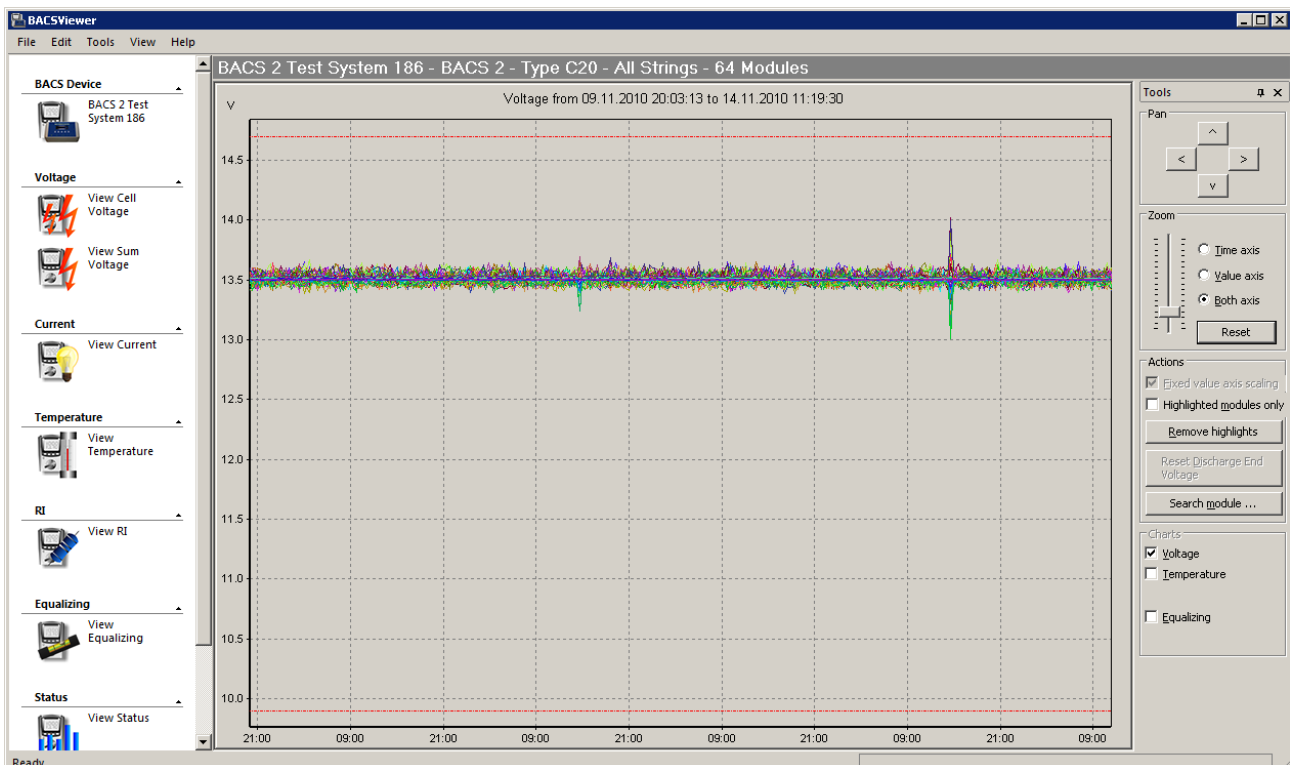

Figure 50: EQUALINK voltage analysis, showing alarm thresholds as red horizontal line

You can now see all battery voltages from the beginning of your timeframe and the alarm thresholds for voltage as horizontal red lines. You may now zoom inside or highlight batteries using the EQUALINK Viewer functions as described further in this manual into chapter 6.6.2.

### Discharge list

If the EQUALINK viewer found discharges in the past, these will be displayed in the list “Discharge”. By clicking one of these discharges in the list, you are guided directly to an analysis of this discharge process. The EQUALINK Viewer now shows a window of this discharge process from start until the power has returned.

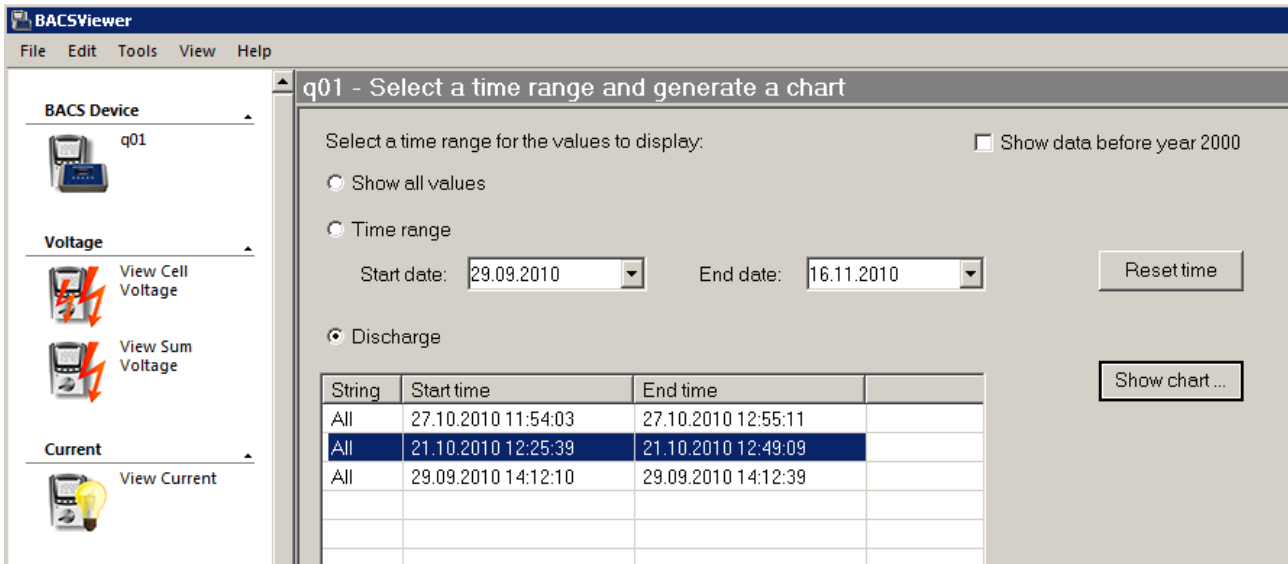

Figure 51: EQUALINK Selection Discharge

In the following we show an example for such a “Discharge” analysis.

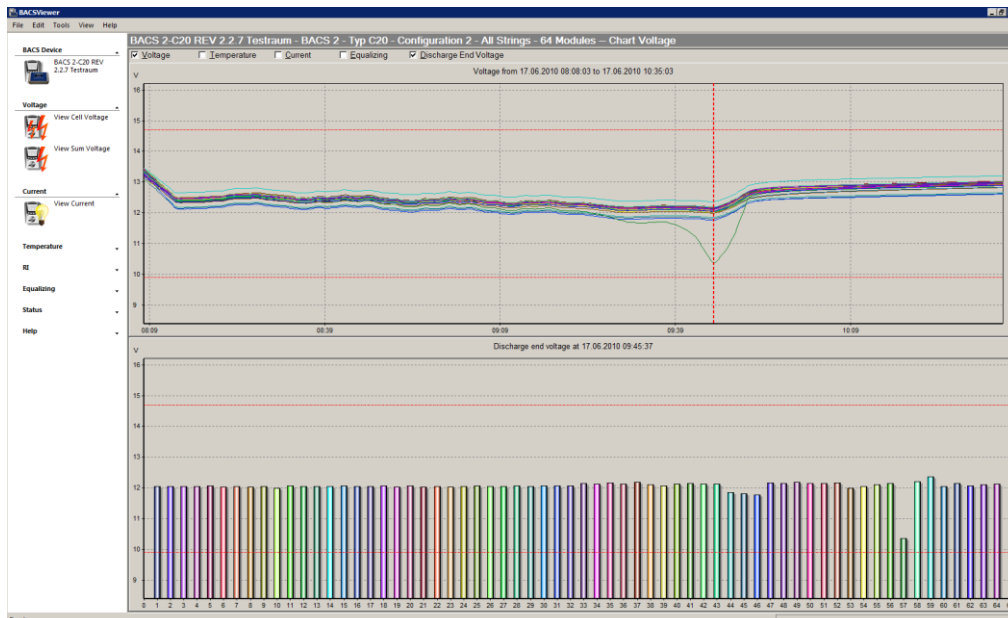

Figure 52: EQUALINK deepest discharge point shown are vertical red dotted line

In the figure above you can see such a “Discharge” analysis. The upper window shows start and end of the discharge and the voltages of every single battery. At the vertical red dotted line the discharge has ended. In the lower window the discharge end (position of the vertical red dotted line) is shown as column for every battery. In this example you can see that battery no. 57 collapsed (compared to others), but could be correctly charged / recovered again through Balancing later.

This analysis tells you to keep an eye on no. 57 and the neighbor batteries at next discharge, and the growth of impedance of this battery during the next 3-4 month has to be watched carefully.

In the “Discharge” window you may move the red dotted line to right or left with the mouse cursor; this shows you directly the individual battery voltages at the point where you have moved the line.

To reset the red dotted line back to the end of the discharge, click the “Reset Discharge End Voltage” button in the tool bar.

Like in any other EQUALINK Window you can use the “Zoom” function for further analysis to find certain battery curves for “highlighting” or to “isolate” from others.

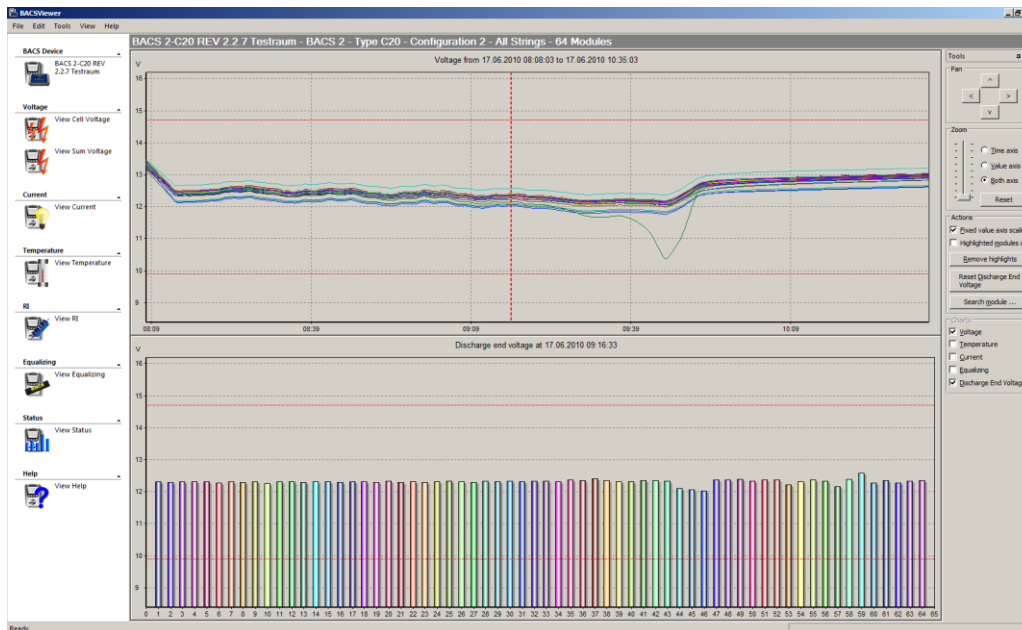

Figure 53: EQUALINK dashed vertical red line shows the end of this discharge process and related voltages of every battery at this point

### 6.6.2 “Zoom-In” Tool

You can use a mouse or a keyboard to zoom in charts.

You have several choices to zoom in:

- A. Select the desired axis in the “Tool Bar” and move the zoom slider up to zoom the area in the center to the EQUALINK Viewer screen.
- B. Keep the “ALT” button and the left mouse button pressed and drag a box from left-top to right-bottom, to zoom into this area. For zooming further in you can also use the mouse wheel or simply drag another rectangle.
- C. Press the “ALT” button and left-click with your mouse into the area, which you want to zoom-in centered.
- D. Press the “PLUS” (+) button on your keyboard to zoom the centered area.

### 6.6.3 “Zoom-Out” Tool

You can use a mouse or a keyboard to zoom out charts.

Execute one of the following steps:

- Select the desired axis into the “Tools Bar” and move the zoom slider down.
- Press the “ALT” and the “CTRL” button and left-click with your mouse into the center of the area which you want to zoom-out.
- Press the “MINUS” (-) button on your keyboard.

#### 6.6.4 “Reset Zoom” Tool

Click the “Reset” button in the “Tool Bar” to bring the zoom level back to the initial and you can start a new analysis of the data again.

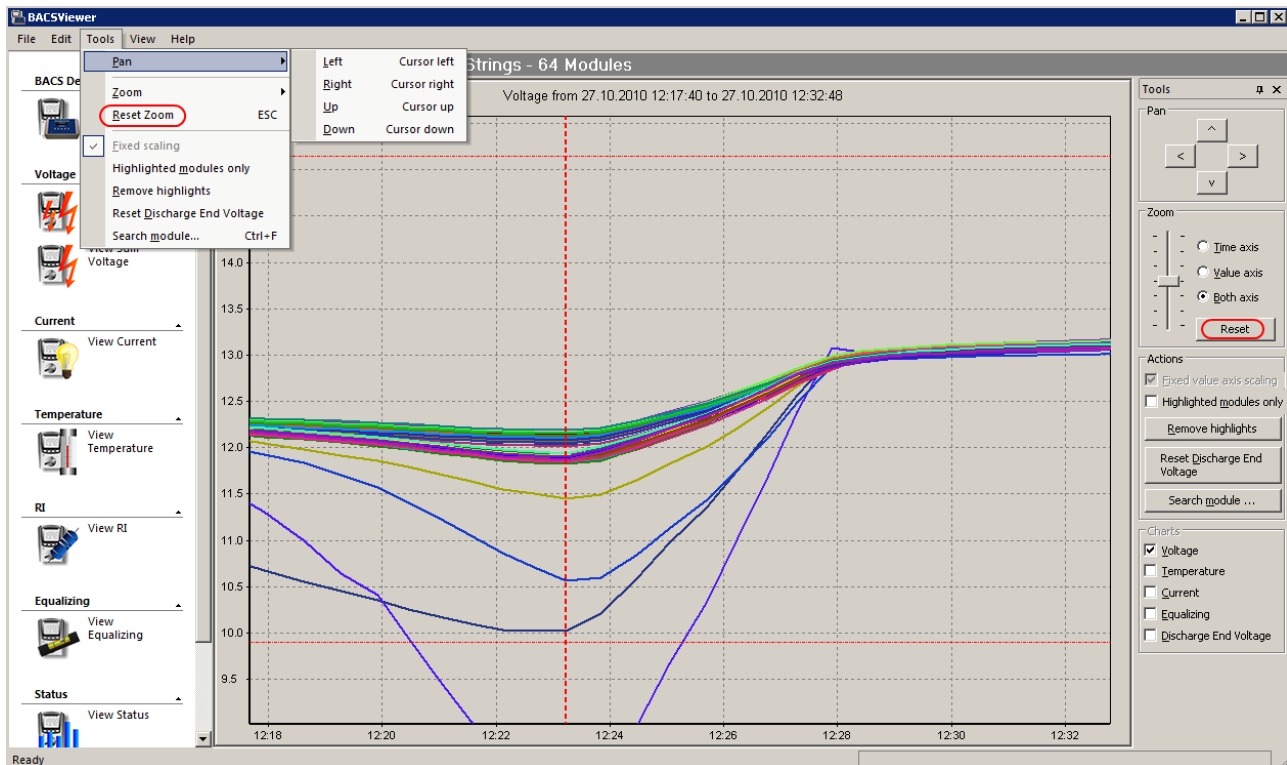

Figure 54: EQUALINK Tool “Reset Zoom”

#### 6.6.5 “Pan” Tool

You can use a mouse or a keyboard to pan the area within the chart. To move/pan the area in the chart, you have the following options:

- Click with the mouse button on one of the pan arrows into the “Tools Bar” to pan the center of the picture into the desired position.
- Use the arrow keys on your keyboard.

#### 6.6.6 “Identify Batteries” Tool

To identify the battery in the curve you are analyzing, you have to zoom in until you can move the mouse cursor over the line and to the exact position which you want to see. Click the left mouse button; as long as you keep the mouse button pressed, the mouse cursor will show the battery number, date/time and measured value at the position on this curve.

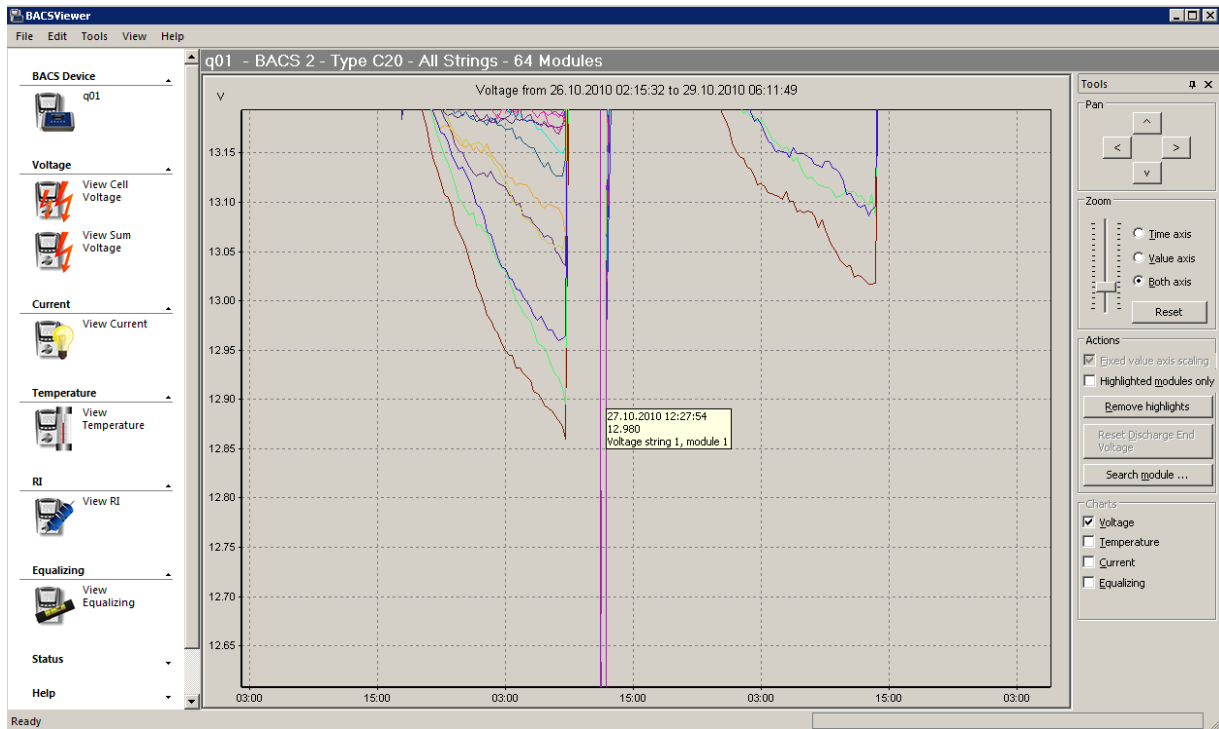

Figure 55: EQUALINK Colored Module Identification

### 6.6.7 “Suppress Recording Gaps” Tool

The EQUALINKViewer version 4.3.0.4 provides the feature to enable or disable the “Suppress recording gaps” function. Gaps can occur, e.g. if the EQUALINK Webmanager is rebooting.

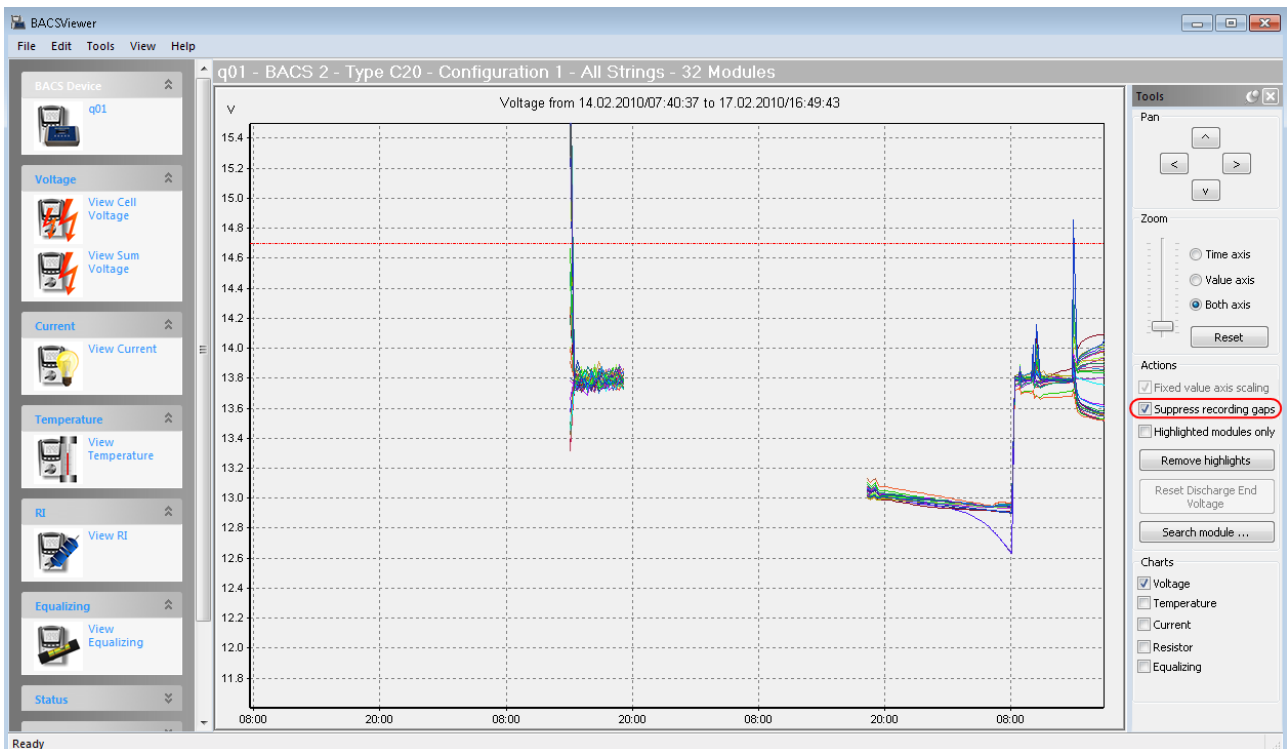

Figure 56: EQUALINK Suppress Recording Gaps Feature Enabled

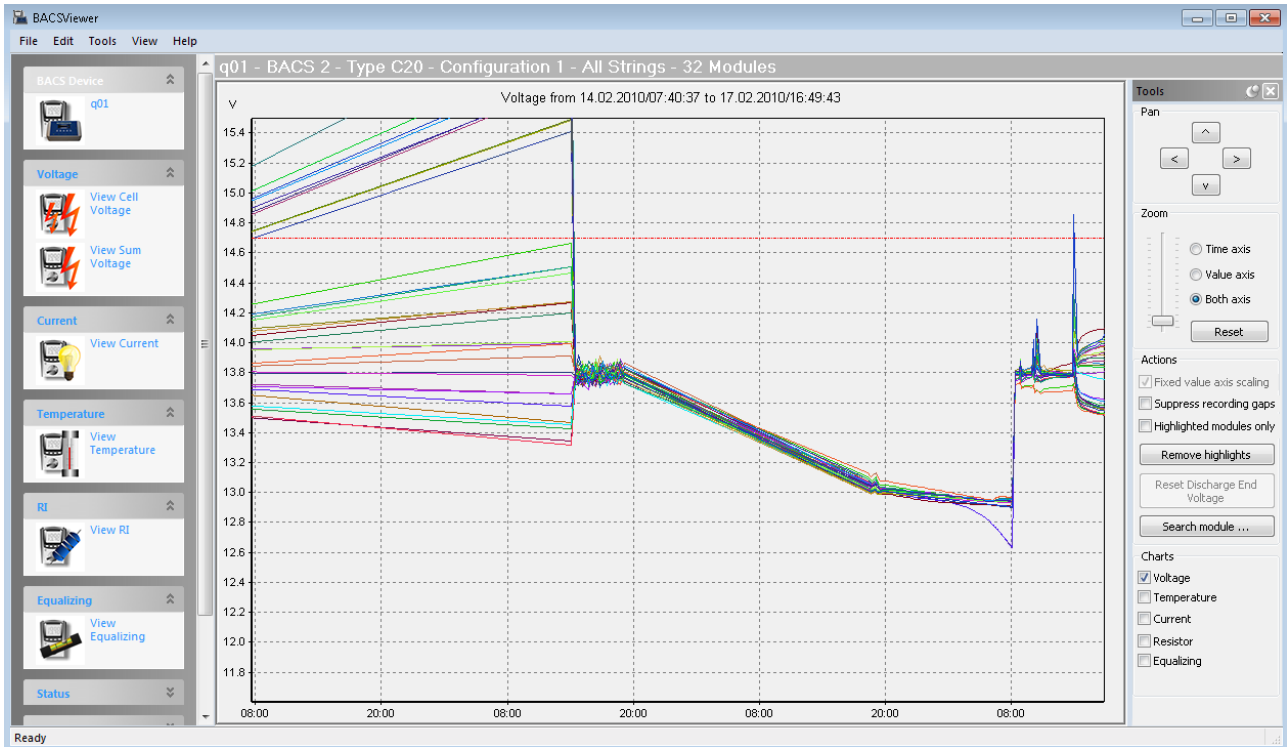

Figure 57: EQUALINK Suppress Recording Gaps Feature Disabled

### 6.6.8 “Highlight Batteries” Tool

You can highlight the curve of a certain battery if you select the desired one and mark it as “bold”. Highlighting allows you now to see the behavior of this battery compared to other batteries within the group. Keep the “SHIFT” button pressed and click on a single line/curve at the same time, to highlight or mark it in terms of color.

A highlighted battery shows itself as a bold curve/line now, while the others remain at normal size. See into the figure below the highlighted battery as bold blue line.

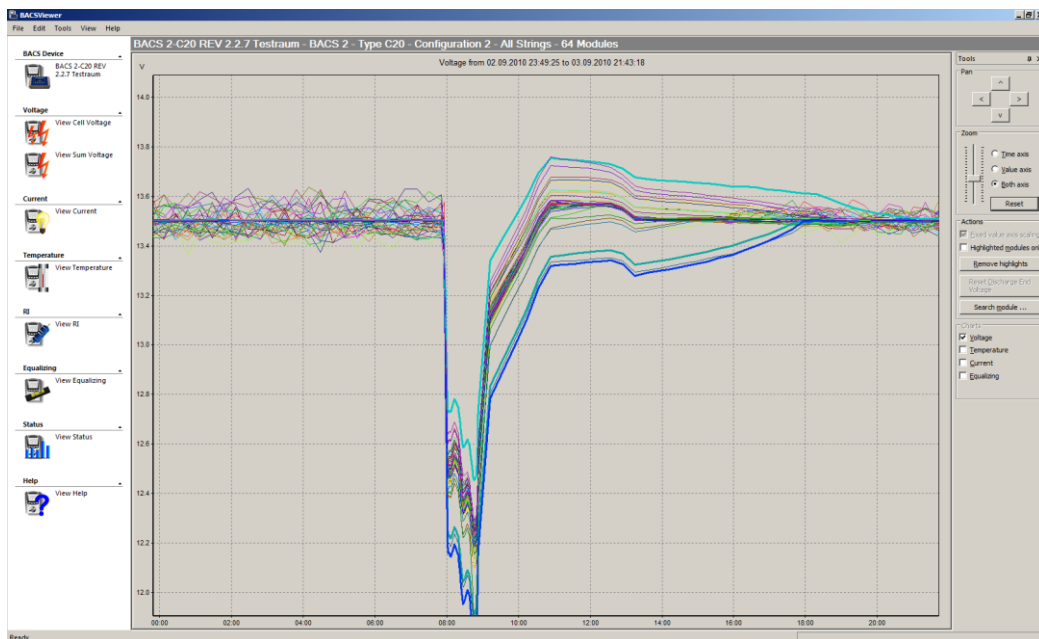

Figure 58: EQUALINK “Highlight” Function

## 6.6.9 “Isolate Batteries” Tool

You can isolate batteries in all charts, to see only highlighted batteries. After you have highlighted the desired battery, enable the “Highlighted modules only” function into the “Tools Bar”. Now all other battery curves are hidden and you see only this battery.

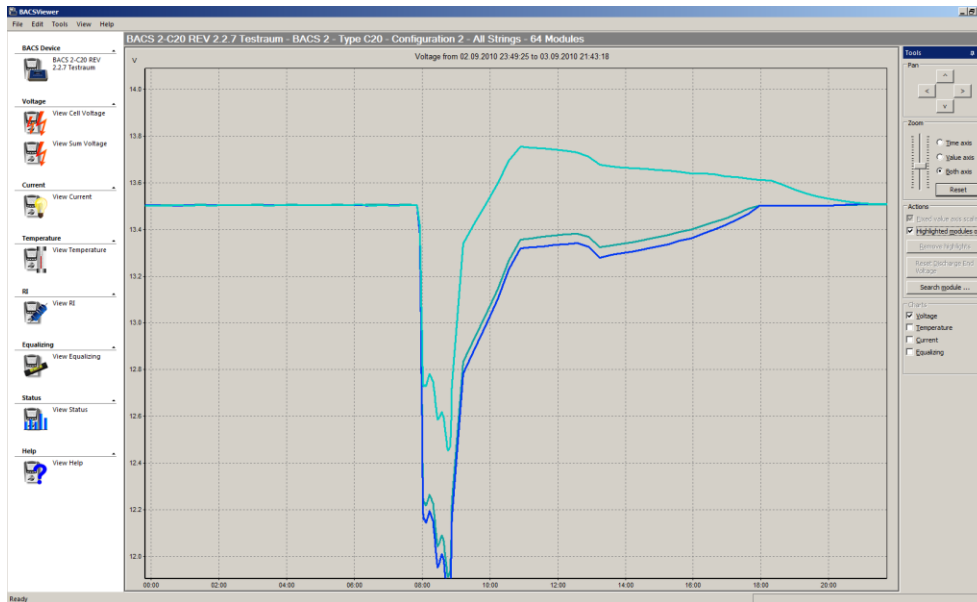

Figure 59: EQUALINK “Isolate” function, hiding all other battery lines

All “Tool Bar” or other functions which were described above for the analysis of the voltages, are identical for the analysis of the EQUALINK current, EQUALINK temperature, EQUALINK Balancing and EQUALINK impedance analysis.



## 6.7 Current Analysis (Optional EQUALINK\_CS Current Sensor Required)

Current analysis is identical to the procedure used for voltage or other values being analyzed. It is an optional sensor that provides current data. You may not find these values in your EQUALINK data, unless you have installed the EQUALINK\_CS Sensors (optional). If a Current EQUALINK CS Sensor is installed you can see the value of the Amperes that are taken from this battery string during discharge and how much is taken in during the following charging process.



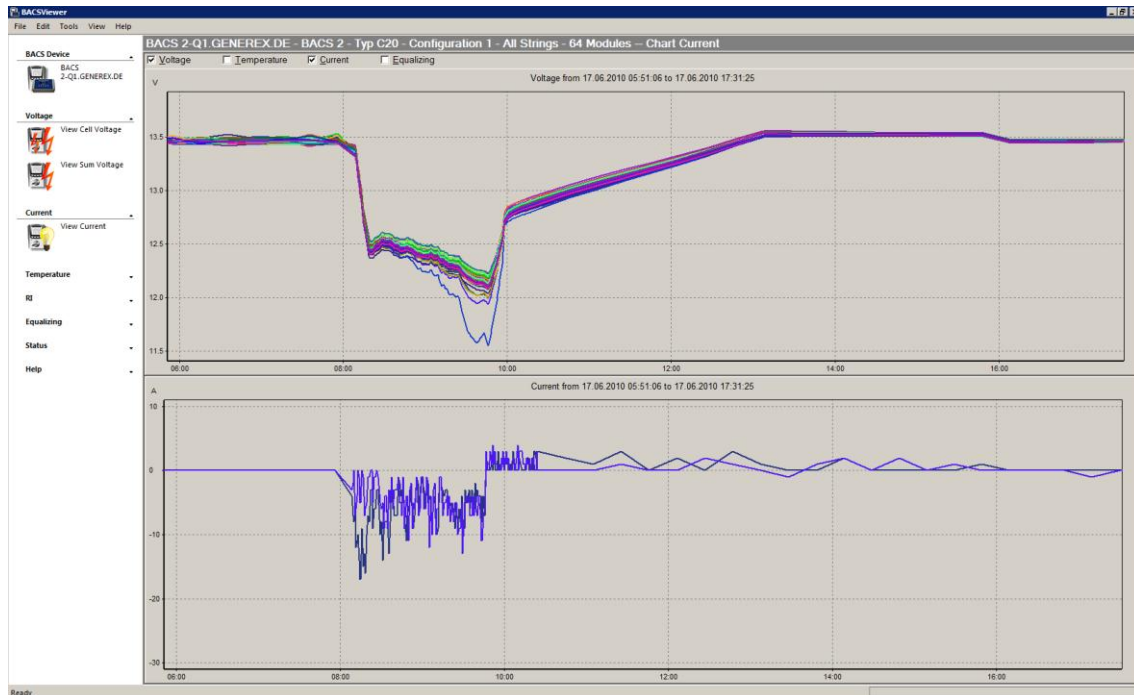

Figure 60: Current curve of string 1 and 2 during discharge/charge

In the graphic above you can see a discharge and charge process; in the upper window you can see how the voltages falls and then rises back during the recharge; in the low window you can see the current in Ampere during this process. During the discharge the batteries in string 1 and 2 show a max. current of -15A, in the charge phase only up to +4A, getting less by the time the batteries reach their full charge level. Negative values show a discharge and a positive value show a charge process. The discharge and charge of both strings should be almost identical. If any string shows a far higher current during discharge than the parallel string, then this is a signal that there may be a problem in one of the strings present. In this example you can see that the discharge in string 2 is higher than in string 1; this is an effect which comes from different battery types and qualities in these 2 strings, which is suboptimal.



## 6.8 Temperature Analysis with the EQUALINK Viewer

Temperature analysis is identical to the procedure used for voltage or other EQUALINK values. Since every EQUALINK module has a temperature sensor on board, you can very precisely see how much a battery's temperature rises during a discharge and following charging process. A rise of temperature of +10° to +40° may be regarded as "normal" at a discharge process under high load, but after the batteries have been fully recharged the temperature should be back at the normal level, before the discharge began.

Watch out if you receive temperature alarm emails or messages! If batteries get corrupted, they signal this in a constant increasing heat of the battery. So if any battery shows a constant rise in temperature, check immediately if the measurement is correct – and if so, be alarmed if this battery temperature rises significantly faster and higher than other batteries within the group. This may be a signal that a "thermal runaway" could happen on this battery, which requires immediate action.

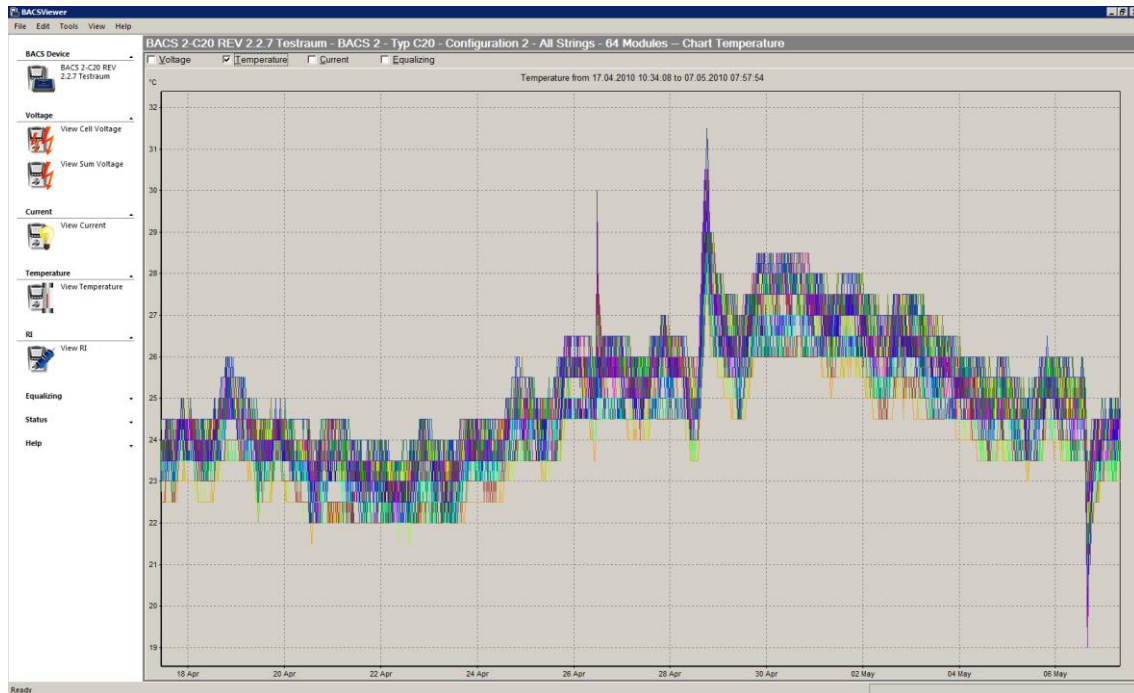

Figure 61: Battery temperature rise and fall due to environmental influence or discharges

In the picture above you can see that the battery temperature goes up and down due to the outside temperature (day/night temperature change). Peaks in temperature may come from discharges/charges, but as long as after the temperature goes down again within 8-10 hours after discharge, the effect of the outside temperature is visible, there is not any battery thermal problem.

Since outside temperature may change drastically in a battery room or cabinet, you should set the alarm levels accordingly. Only if the battery temperature increases steadily, over 40° and more, than you have to react immediately because this indicates a thermal runaway.

**i** ATTENTION: Observe the battery temperature up to 12 hours after discharging! Ongoing at discharging "thermal runways" could occur directly, massive increase of the temperature at damaged batteries, which could lead to a fire. The danger of a battery breakdown and damage of the system is very high up to 12 hours after discharging. Afterwards a battery group can be seen as stable and can be integrated into the normal alerting. Until then be careful and react immediately by cut-off of the charger, if the battery temperature increase instead of being constant or decrease after the discharging. Also if no noticeable problems were visible in the voltages during discharging, it can mean that the batteries can be altered in a short period of time and may show a massive increase of the temperature, which could lead to a fire. The critical time here is between 3 to 12 hours after discharging. If the temperature has decreased, then it will not change in a short period of time. Otherwise react immediately and switch off the charger!

Besides watching extreme temperatures during discharge/charge, you can also see in which environmental conditions these batteries have operated in general. If batteries are constantly kept in rooms with a temperature of more than 25°Celsius, then you have to expect a drastic reduction of the total battery life, whether EQUALINK is installed or not. EQUALINK may extend the lifetime of such batteries, but the higher the temperature of the battery room is, the less the EQUALINK Balancing can show a positive effect on the lifespan of the batteries. Try to keep batteries cool and you will gain the most out of the EQUALINK management functionality.

**i** Advice: Batteries are classified by the manufacturers in service life. Therefore the "EUROBAT" standard is used in Europe. Thus batteries with "Eurobat 12+" are designed for 12 years and more. In addition the manufacturers declare the exact date, e.g. 15 years. All details are valid at 20°C. If the temperature is 10°C higher, the corrosion will boost massive and the value has to be cut in half, that means of the 15 years remain 7.5 years of prospective service life only. At 40°C the service life would be less than 4 years and at 50°C only 6 months. For this reason it is important to monitor the temperature of the batteries, to induce an earlier exchange at steady high temperatures.

**i** Advice: It is required that the charging voltage has to be changed, per degree Celsius temperature increase or decrease of the value of 20°C, to reach the stated lifespan of the batteries from the

manufacturer. Generally lead-based batteries are effected on an increase of 0.03V per degree Kelvin (-272,15°C) to be affected if there is a temperature change. Example: A battery rated for a sustainment charging of 13.52V at 20°C. If the environment temperature is 25°C now, that means, that this is a decrease of the charging voltage of 0.15V.

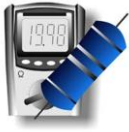

## 6.9 RI Impedance Analysis with the EQUALINK Viewer

“RI” means Resistance Impedance and is showing the EQUALINK data for electrical resistance, also called impedance.

Impedance indicates over time if battery replacement is necessary or not. It is the only relevant data which will give you a feedback about the battery health during charging/float charging phase or no load. Battery voltage is not a measurement for identifying weak batteries as long as the charge is running or no load is applied. Unfortunately this is exactly the situation you find in any UPS or other battery-operated appliance – the batteries are under maintenance charge and do not carry any load – without discharging the batteries at a high load you cannot distinguish good batteries from bad ones. But such a discharge always has the risk that these bad batteries fail – and the system collapses in seconds, or even worse – the system showed correct voltages during the discharge while being watched, but in the following charging phase these batteries which survived the discharge are now defective and will cause a collapse of the system next time.

The only way to find out if a battery is good or bad during a float charge is measuring its impedance in “secure” voltage windows and over a long period of time. “Secure” has to be understood that the voltages and temperatures of all batteries in the string should be as close as possible to allow a comparison. The Equalizing/Balancing feature of EQUALINK secures that the voltages are harmonized and impedance can be compared.

Impedance increase is a normal process of any battery over the time and is an indicator for the aging of batteries. Rising impedance is also an indicator for loss of active material, short circuits across the plates, corrosion on the positive grid, dry-out and sulphation. So through impedance history you can see many battery problems although the charge is active and without the risk to make the system collapse. A fast rise of impedance warns you also for the following problems beside those mentioned above, like thermal runaway. Additionally the impedance is a quality index for the battery within your group. If all batteries come from the same source and have the same production date and quality, then they should not differ very much regarding impedance. In the picture below you can see that these batteries differ considerably, most are at 20 mOhm, but there are several with 30 and more, increasing much faster than the others. This is an indication for several defective batteries within this system, although the battery voltage did not show any problems.

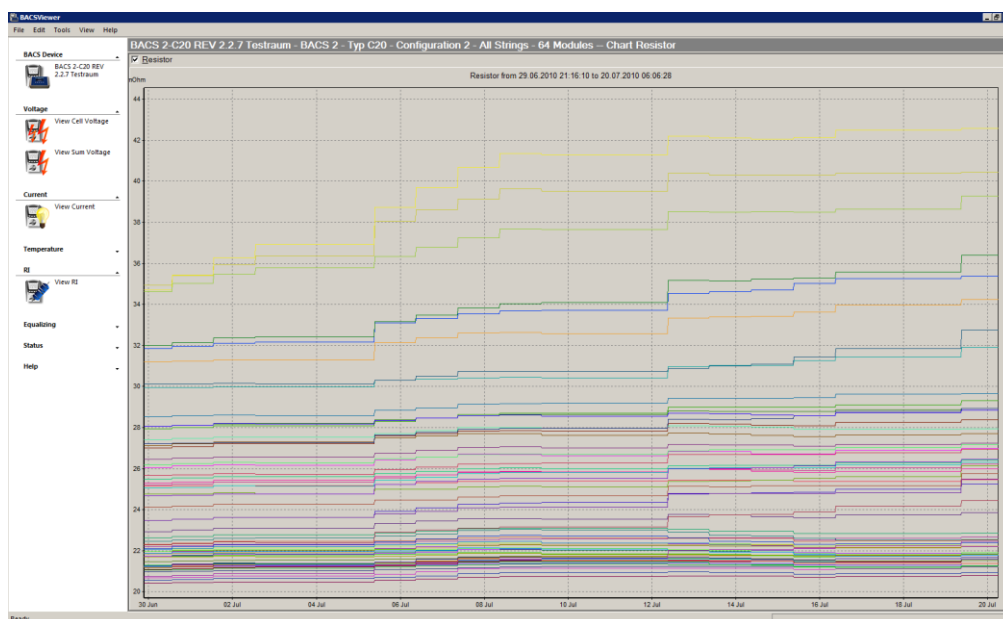

Figure 62: Increase of impedance showing aging of batteries and defects

Generally the overall impedance of your batteries should not increase more than 5% per year, if you keep it in a controlled climate and with an ideal charger. If temperature is not stable, or many discharges or false charging operations occurred, then this increase will be faster and your battery life will be shortened.

Generally the impedance curve in EQUALINK should show an almost horizontal line, so you should not see any major change for 90% of the battery life – unless there is a problem.

In the picture above you can see that batteries which are OK do not show any significant increase, while others do have this effect, and rise faster than the others.

The absolutely measuring value (numeric value) of RI in milliohms does not describe the state of a battery directly. Because the manufacturers of the batteries are measuring the RI with different measuring devices, the values are comparable only, if identical measuring devices were used and the environmental data (temperature, battery voltage) were the same. Since this is almost never the case, the absolute measuring values in milliohm, which are determined from EQUALINK, are not always comparable with the data from the manufacturer. Exception: The HIOKI measuring device “Battery Hightester” model 3554 determines almost identical measuring results at correct handling like EQUALINK, but these models only. Other HIOKI models determine other absolutely measuring values, but proportional to the EQUALINK values identical.

The difference of the RI measuring within the batteries is more important than the absolute measuring value. The tighter the measuring values match (e.g. all batteries have a measuring value +/- 10%), the better the state. The farther the batteries are apart, the more this difference increases, the worse the state of the batteries, which gets worse proportional to the initial value at the start-up.

Basic rule for VRLA batteries: An increase of the RI during normal operation from the start (baseline) within less than 30% is tolerable. An increase of more than this is critical, and change of the battery should be considered.

Example: The majority of a battery group is between an area of 3.5 and 6.5 milliohm. At exceeding of 8.45 milliohm (6.5 milliohm + 30%) of a battery, an alarm level should be set, to check this battery.

Basic rule for flooded cells OPzS batteries: An increase of the RI during normal operation from the start (baseline) within less than 20% is tolerable. More than this is critical and change of the battery should be considered.

Basic rule for Ni-Cd batteries: An increase of the RI during normal operation from the start (baseline) within less than 50% is tolerable. More than this is critical and change of the battery should be considered.



**Advice:** The first RI measurement starts 15 minutes after reboot. The delay is implemented to avoid false measurements, because the voltages are not yet harmonized. The 2nd, 3rd and 4th measurements take place 15 minutes later; after 60 minutes the system will measure impedance only once per 24 hours.

### 6.9.1 RI Impedance Analysis with the EQUALINK Viewer Baseline

The EQUALINK Viewer version 4.2.0.0 provides the Baseline function for the support of the impedance analysis. This function displays the change of every battery since the start of the measurements (limited through the selected time range). The following figure displays an optimal RI baseline, with a difference of just a +1.5% increase.

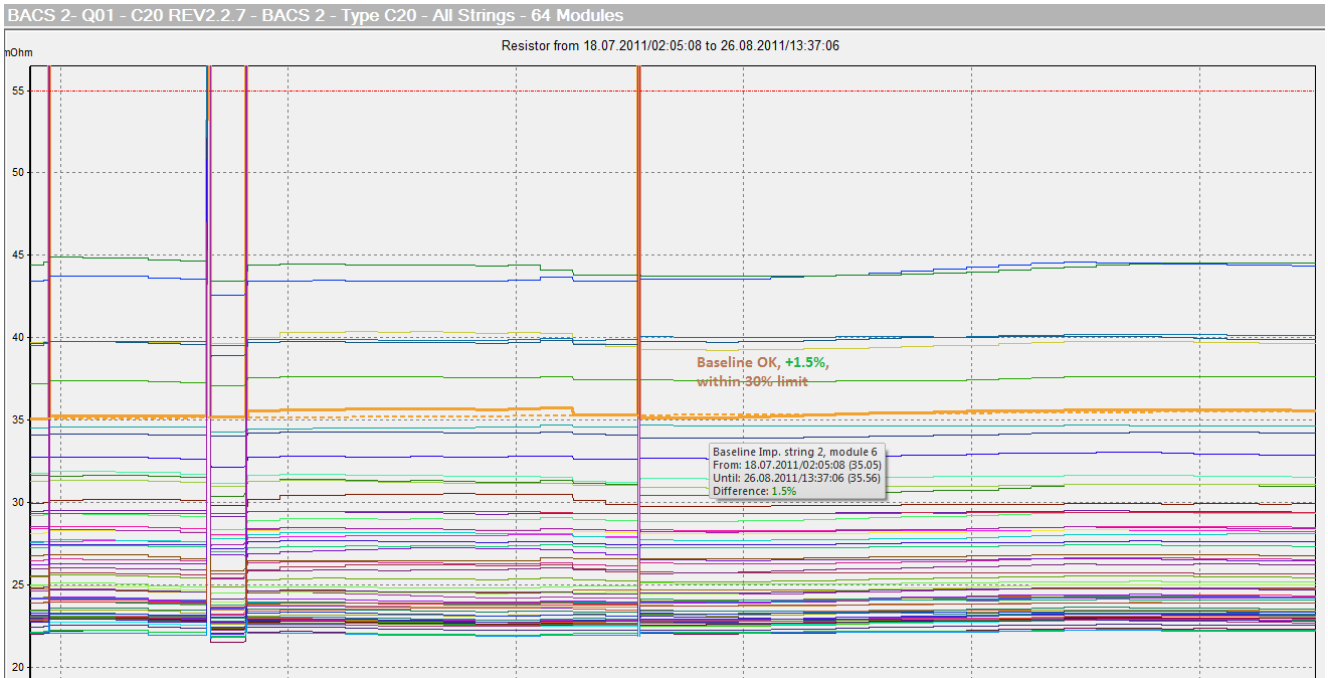

Figure 63: Impedance Baseline with small change

The following figure displays the baseline (dotted line) where the green battery RI has increased +11.6% and is now within the warning area (10% to 30%).

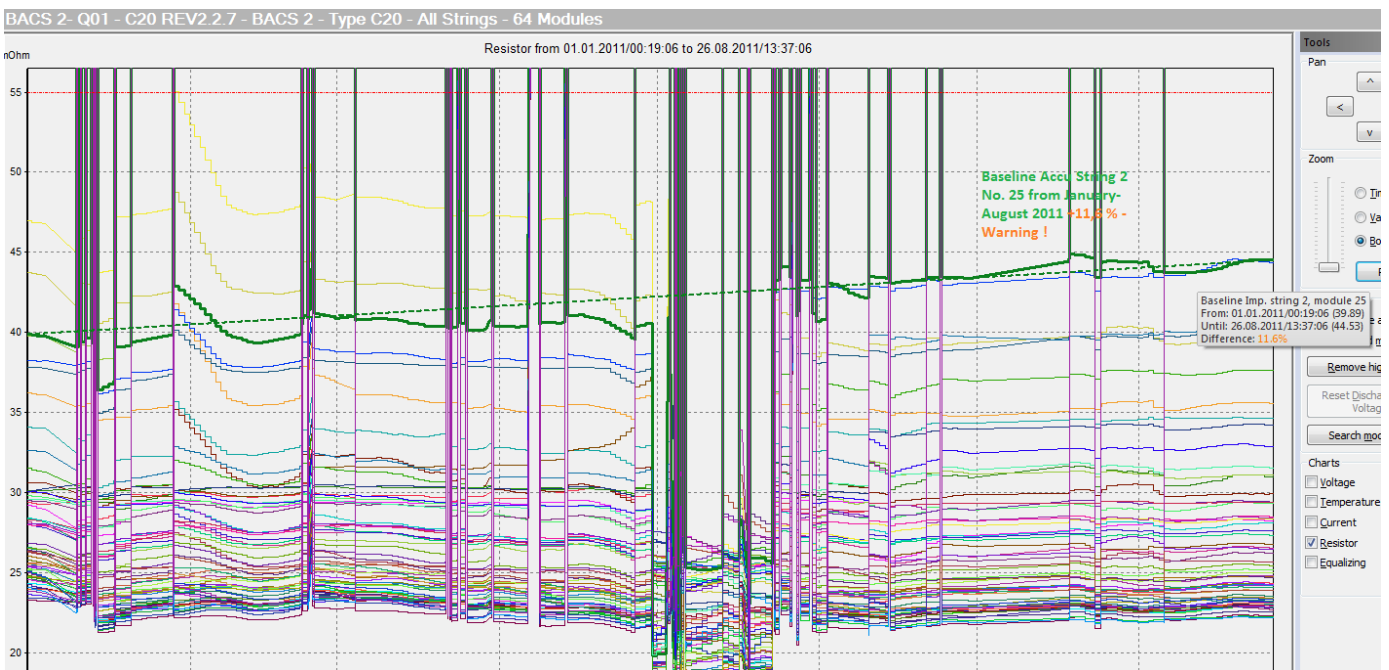

Figure 64: Impedance Baseline with course into warning area

The next figure displays a baseline with a difference of +95.7%. This is abnormal and may indicate that a wrong measurement was made within the selected time range. Please select a shorter time range for the analysis and see if now a reasonable value is found and compare this with other batteries in the same time frame.



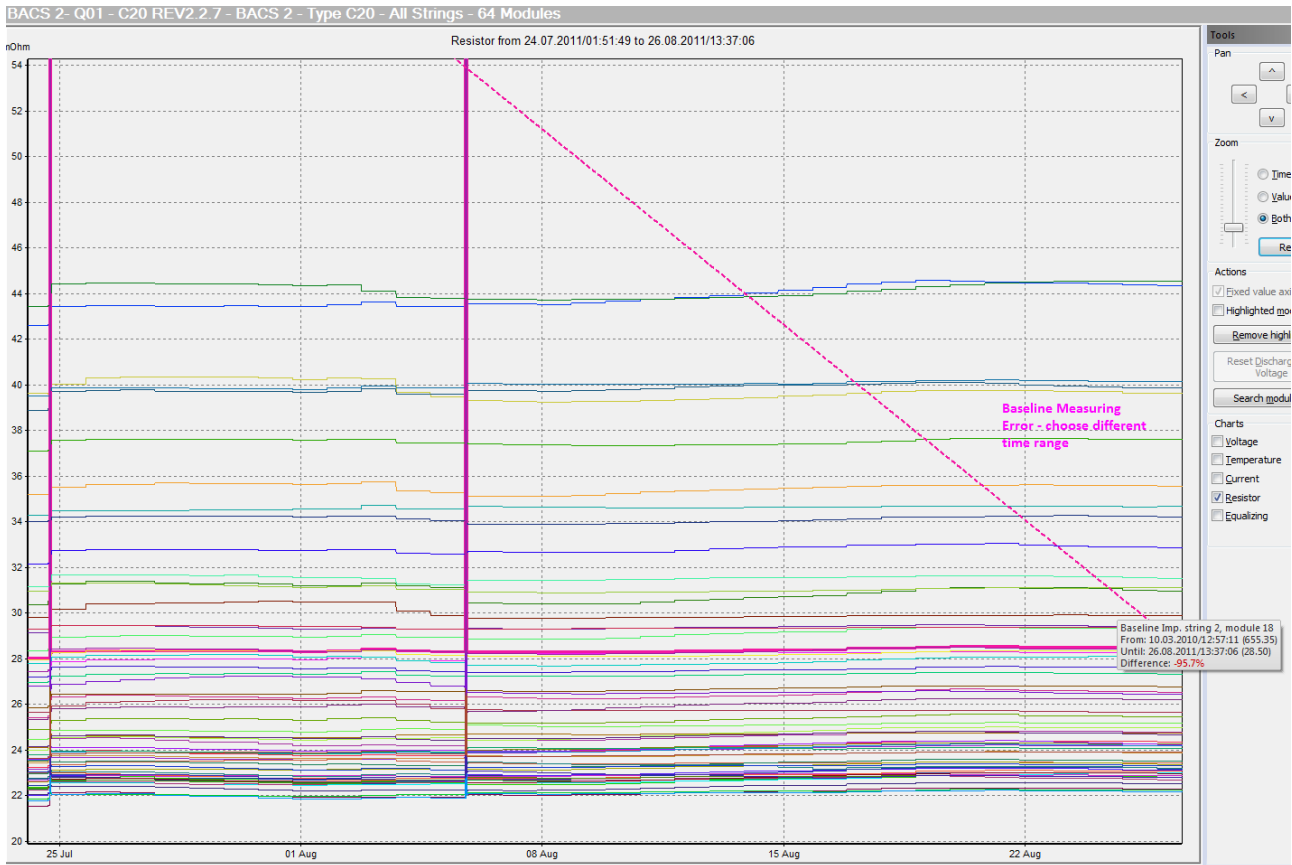

Figure 65: Impedance Baseline with Measuring Error



## 6.10 EQUALINK Equalization/Balancing Voltage Analysis

This graph shows you the Balancing power per battery during charge process.



Figure 66: EQUALINK Balancing Chart, showing the effect of Balancing on battery No. 59, avoiding overcharge.

Balancing is a patented “care” function to avoid damage to batteries through over or under charging.

The level and the duration of the Balancing power is displayed via the EQUALINK Viewer as shown in Fig. 51. A system that only requires the Balancing process for just a short time period is a good system or a well-balanced system. That means that the batteries are not drifting very much and should be in good shape.

**How Balancing works:** See Figure 51: You can see how the Balancing process works with this example. The light blue battery curve, marked with red arrows above, shows that this battery wants to rise over 13.5 V. The figure below displays the Balancing current on this battery of 100% as long as this battery receives too much charging voltage. The EQUALINK module connected to this battery tries to prevent this risk for overcharging with full performance. At 5 p.m. the other batteries have now increased their own voltage level and are now also fully charged, so that the Balancing current of the light blue battery can be reduced. At midnight the light blue battery requires just a small amount of Balancing current and now behaves like the other batteries. Here you can see how the Balancing process protected this battery from being overcharged for 12 hours.

If the Balancing process continues for a long time then the EQUALINK system will counter-steer constantly against the battery charger to avoid overcharge or undercharge of certain batteries. This is a “normal” process and very common the more batteries that are formed into a group. The more batteries that are in a group, the more the probability to have several batteries outside the voltage level which is not “ideal” and require extra charge or discharge. If such batteries are not balanced, they would drift away and may get damaged by sulphation (undercharge) or dry out (overcharge). This problem is eliminated by the EQUALINK patented balancing and the graphic above shows the results of this “repair work” on every battery.

Balancing is only active during the charging phase, e.g. at 12 Volt batteries starting beyond 13.2 Volt. EQUALINK starts at 12 Volt batteries with its treatment only if some batteries do not follow the charging levels like the majority of other batteries.

Balancing is set “active” as default in an EQUALINK system. The better the batteries are, the less the amount of balancing power to keep them in the optimal capacity.

**Permanent Balancing:** Balancing is an automated process, controlled by the EQUALINK WEBMANAGER. Although it is normal that the more batteries that are in a group, the more balancing power is required, it should be kept in mind that a constant “counter steering” of EQUALINK may also show a general problem with the charger or one or more batteries which EQUALINK will not overcome and additional maintenance action should be taken.

Such a problem may be the so-called “Permanent Balancing” - this is a system where all batteries show constantly a high Balancing power (almost all accumulators > 80% Balancing for more than 2-3 weeks). If Balancing is constantly counter steering, it may be that a defective battery is within this group which cause such a malfunction of the charger. Please check the charger or do a discharge of the batteries to see if there are any accumulators which collapse earlier than others or show high impedance. If such batteries are found, please remove these from the system as soon as possible to lower the Balancing power and avoid a permanent Balancing over 80%.

EQUALINK always supplies a minimal Balancing, even if all batteries are perfect. So in the Balancing Status at the Web browser you may see a grey icon, which indicates that actually the Balancing power is less than 50%. Any Balancing over 50% will be displayed as green to make the “care” process visible. Ideally all batteries do not need more than 50% Balancing, but the more batteries you have in a group, the more tolerance needed for Balancing.

## 7. Other Menus in the EQUALINK VIEWER

### 7.1 Menu FILE

#### **Print**

In the Menu FILE you can setup your printer to print your analysis reports to a local printer.

### 7.2 Menu EDIT/Settings



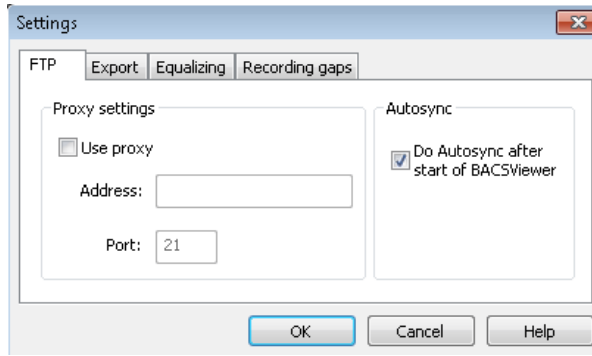

Figure 67: EQUALINK Viewer Menu Edit/Settings

### 7.3 Menu FTP

If you want to use a proxy server, you can define its parameter in the “FTP” page.

### 7.4 Menu EXPORT

If you want to store the data as CSV file on your hard disk, to be able to import the data into an external program, just use “Export”. The export function will create a CSV file which consists of all values for this time range (temperature, impedance, temperature, balancing power and current.)

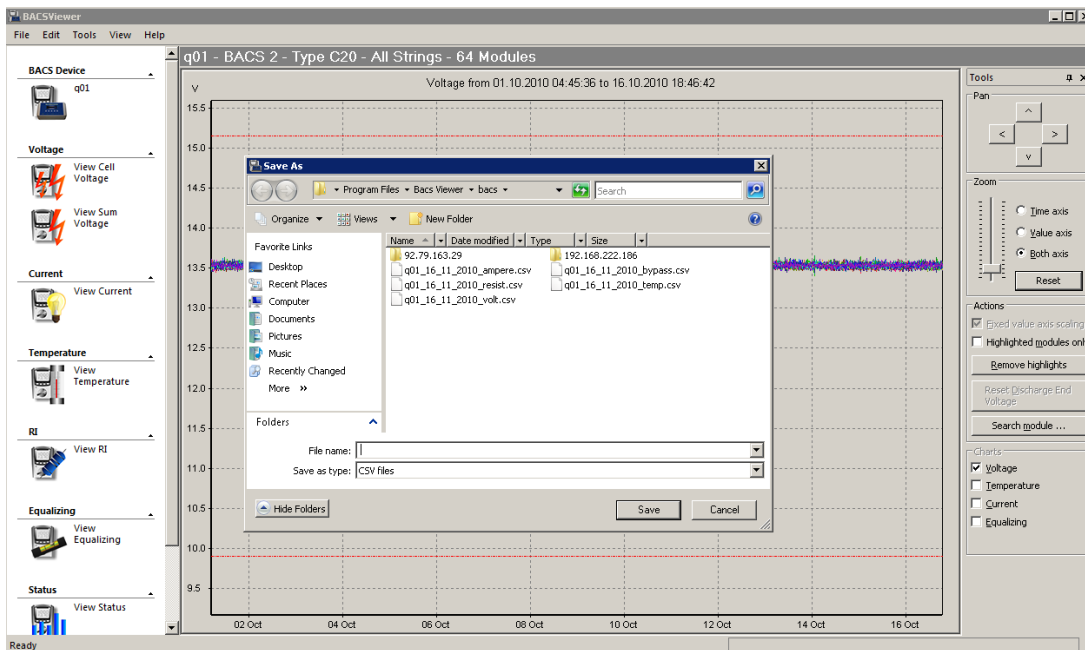

Figure 68: EQUALINK “Export” Function to CSV file format

### 7.5 Menu Equalization/Balancing

The behavior of every single battery is different, independent of the battery capacity (other measuring of the internal resistance and limitation of the Balancing current). This is why it is easier for the operator, if the EQUALINK Viewer internally corrects these adjustments automatically, to make battery installations of different capacities comparable. If you enable the “scale Balancing values” (default is on) then the EQUALINK Viewer shows in the screen “Balancing” all values relative. So if you have a small battery where the EQUALINK module limits itself its Balancing power, the EQUALINK viewer shows up to 100%, identical to the display of the Web browser interface. If you disable “scale Balancing values” then the EQUALINK Viewer shows the absolute value. This will show now that an EQUALINK module provides only 20% of its Balancing power at small capacity batteries. Example: At 7A batteries you will see at “ON” up to 100%

Balancing power, at “OFF” you see the real value, the limitation of max. 20% of the available Balancing power only.

This makes the comparison with other battery capacities easier since you do not have to consider caring about the different amounts of Balancing power anymore; the EQUALINK Viewer always shows you the systems identically if you keep “scale Balancing” on.

## 7.6 Menu Recording Gaps

The EQUALINKViewer version 4.3.0.4 provides the feature to enable or disable the “Suppress recording gaps” function. Gaps can occur, for example, if the EQUALINK Webmanager is rebooting.

NOTE: The function “Show data before year 2000” is disabled by default. Any EQUALINK data with timestamps before year 2000 will automatically not displayed. If you do not have a timeserver set in your EQUALINK WEBMANAGER, than please enable this function to see EQUALINK data before year 2000.

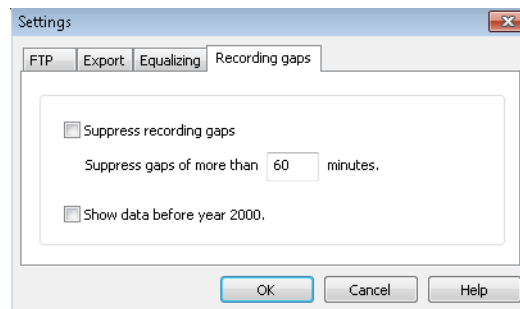

Figure 69: EQUALINK Recording Gaps

## 7.7 Menu View

Automatic scaling of X and Y axis. You can scale the ordinate with the “Fixed Scaling” function (default is on). If this function is enabled, EQUALINK VIEWER will display automatically only the EQUALINK values between the configured limits of alarms. If no limits are found in your EQUALINK data, then the display may be “empty”. To make your data visible, please disable this function.

If you disable this function, all available EQUALINK data are displayed and you have to use the ZOOM in function manually for scaling.

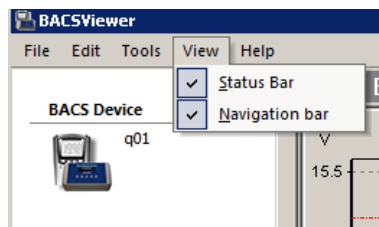

Figure 70: EQUALINK “Fixed Scaling” Function on/off



## 8. EQUALINK Status

You can review the most recent actions or alarms in the STATUS windows. All alarms are shown as text entry with the timestamp of their occurrence.

Conf.	String	Time stamp	Status
1	1	19.07.2010 09:20:39	Charging
1	1	17.07.2010 00:36:36	Discharging
1	1	16.07.2010 08:59:35	Charging
1	1	16.07.2010 00:53:55	Discharging
1	1	15.07.2010 13:00:31	Charging
1	1	15.07.2010 12:40:11	Charging, Volt out of range
1	1	12.07.2010 09:06:16	Charging
1	1	10.07.2010 06:38:36	Discharging
1	1	05.07.2010 09:16:55	Charging
1	1	03.07.2010 06:44:34	Discharging
1	1	02.07.2010 16:49:10	Charging
1	1	02.07.2010 16:26:07	Discharging
1	1	02.07.2010 16:02:22	Charging
1	1	02.07.2010 15:47:44	Charging, Volt out of range
1	1	21.06.2010 16:22:13	Charging
1	1	21.06.2010 15:41:52	Charging, Imp. out of range
1	1	21.06.2010 13:54:35	Charging
1	1	21.06.2010 09:29:53	Charging, Imp. out of range
1	1	21.06.2010 09:09:38	Charging
1	1	18.06.2010 16:47:40	Charging, Imp. out of range
1	1	17.06.2010 10:44:53	Charging
1	1	17.06.2010 08:08:47	Discharging
1	1	09.06.2010 08:53:20	Charging
1	1	09.06.2010 08:33:16	Charging, Volt out of range
1	1	08.06.2010 09:35:35	Charging

Figure 71: EQUALINK “View Status” Overview page showing all events and alarms on this system

## 9. EQUALINK Accessories

### 9.1 EQUALINK BUS CONVERTER II



Figure 72: EQUALINK BUS CONVERTER II

This is the EQUALINK CONVERTER II model, built from 2007 to 2008. Input Power range 9-18V, min. 800mA. Default power supply is 12V 800mA for installations up to 160 EQUALINK modules. For larger installations please provide a power supply with 1.5A.

The power supply should not be shared with other devices to avoid false measuring. Please avoid using a switching power supply type; transformer type to direct supply from a battery would be ideal.

DBSUB 9 Port: EQUALINK CONVERTER offers a DSUB 9 service port to work with the EQUALINK PROGRAMMER Software (for Windows). The PC cable is not included, please use a 1:1 standard RS232 cable, see layout below.

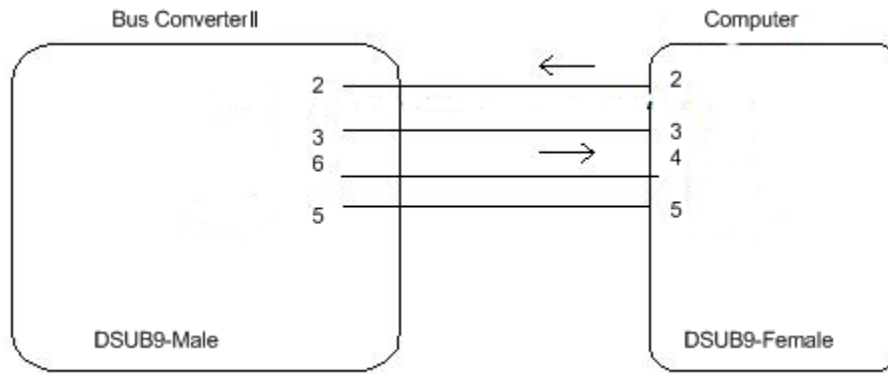

Figure 73: PIN Layout CS121 Config-Cable to Windows PC with EQUALINK Programmer Software

**i Attention!** This service port is only functional if the EQUALINK WEBMANAGER COM3 is not connected!

## 9.2 EQUALINK BUS CONVERTER III



Figure 74: EQUALINK BUS CONVERTER III

This is the EQUALINK CONVERTER III model built from 2009. Input Power range 12-18V, min. 800mA. Default power supply is 12V 800mA for installations up to 200 EQUALINK modules. For larger installations please provide a power supply with 1.5A. The EQUALINK CONVERTER III "Plus" has additionally an internal RTC real-time clock on board as a backup timeserver. If no timeserver is available into your network environment, you can manually set the system time. Click the "timeserver" button into the EQUALINK WEBMANAGER Configuration menu and enter the desired parameter.

Figure 75: Set System Time manually

The power supply should not be shared with other devices to avoid false measuring. Please avoid using a switching power supply type; transformer type to direct supply from a battery would be ideal.

This EQUALINK Bus Converter 3 provides 2 inputs for the EQUALINK bus cables to create a ring from the first to the last module. Through this the cable length can be shorter and the power supply of the standard power supply supplies not up to 200 modules.

Mini 8 Port: EQUALINK CONVERTER offers a Mini 8 service port to work with the EQUALINK PROGRAMMER Software (for Windows). The Original EQUALINK / CS121 Configuration cable requires an

adapter before it can be used with this service port. This adapter can be ordered separately, or you may design such an adapter yourself.

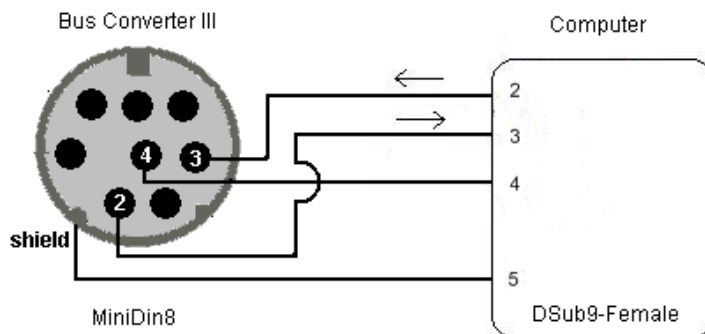

Figure 76: PIN Layout CS121 Config-Cable to Windows PC with EQUALINK Programmer Software

**i Attention!** This service port is only functional if the EQUALINK WEBMANAGER COM3 is not connected!

### 9.3 EQUALINK SPLITTING BOX



Figure 77: EQUALINK SPLITTING BOX

The EQUALINK SPLITTING BOX is a passive splitter for EQUALINK communication cable and can be used for the optimization of the cable lengths and for the creation of visual symmetry of the wiring. In addition to the extension of the 2 EQUALINK bus inputs at the EQUALINK CONVERTER for e.g. the bonding of EQUALINK DC Current Sensors. We recommend to use the EQUALINK SPLITTING BOX if you want to connect more than 50 EQUALINK modules into the EQUALINK bus.

### 9.4 EQUALINK CSxxx Current Sensors



Figure 78: EQUALINK\_CS300 and EQUALINK\_CS\_500 DC current sensor

#### Description & Functions:

The EQUALINK\_CSxxx Current Sensor is a measuring unit for the integration into the EQUALINK II bus system. This unit provides the measuring of the string current into the negative or positive range of a battery circuit and displays the data in Ampere.

The active measuring value will be displayed via the web-interface, the EQUALINK II Webmanager showing the "EQUALINK Status" of the string (Fig.62). The measuring values will be stored sequentially in the history

files and this data can then be used later for system analysis and performance interpretation by using the EQUALINK Viewer software.

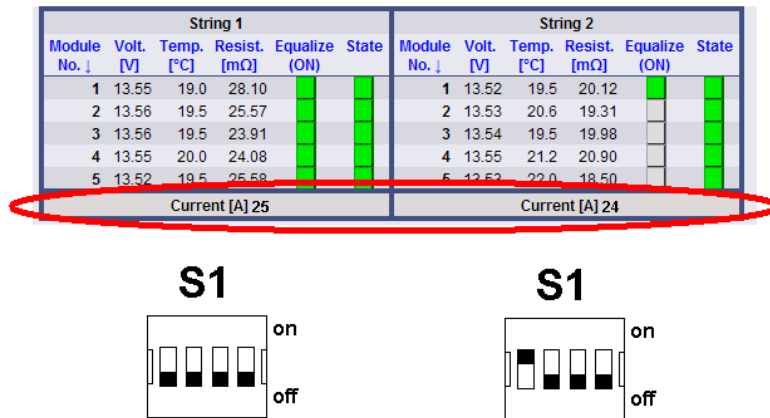

Figure 79: EQUALINK\_CSxxx

**Assembling:**

The EQUALINK\_CSxxx Current Sensor is designed for DIN Rail mounting.

**Bus Connection:**

The EQUALINK CSxxx sensors (one or more units) should be connected to the EQUALINK CONVERTER via a separate communication bus cable. Do not mix an EQUALINK\_CSxxx Current Sensor into the same communication bus string where EQUALINK Modules are connected.

Connect the "X1"-RJ10 socket of the EQUALINK\_CSxxx Current Sensor with any EQUALINK bus-cable to the "battery bus" of the EQUALINK CONVERTER or an input of the EQUALINK SPLITTBOX. Please reserve one of the 2 inputs "battery bus" at the EQUALINK CONVERTER, or if occupied, at the EQUALINK SPLITTBOX for the EQUALINK Current sensor bus to avoid conflicts with the EQUALINK C modules and to get a clear signal at longer cable lengths. You can connect up to 8 EQUALINK\_CSxxx Current Sensors on this bus. Use the "X2" for the connection to the next EQUALINK\_CSxxx Current Sensor.

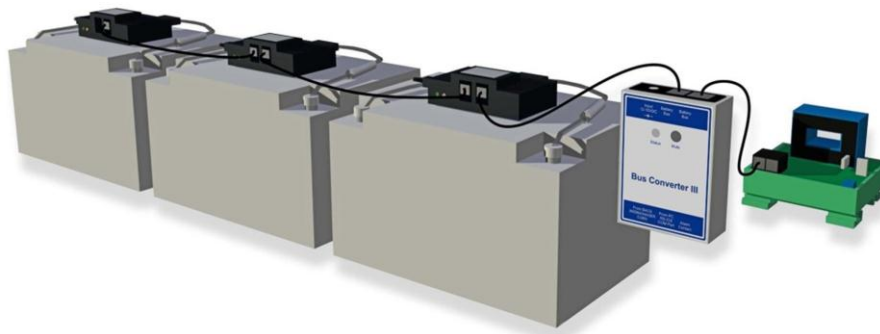

**Battery Circuit Connection:**

Put the cable of the battery circuit you want to measure through the transducer "W1" on the EQUALINK CSxxx Current Sensor. Check to make sure the cable is placed in the unit in the correct direction to measure the flow of current (see marking of the EQUALINK\_CSxxx Current Sensor, Fig. 63)!

**Addressing:**

The EQUALINK\_CSxxx Current Sensor can be addressed via the DIP-Switch "S1". The string number and the address will be defined via the switch setting of the switches. The measuring value will be displayed below the string number (see Fig. 2). The EQUALINK II Webmanager detects the connection of the EQUALINK CSxxx current sensors and will automatically monitor and display the measuring value for each of the strings accordingly the position of the DIP SW. Please note that it is required to enable the function "EQUALINK CS Current Sensor connected" into the EQUALINK Configuration menu. If you want to change the setting of the switch into operating mode, it is required to disconnect the power supply via detaching of the bus connection, so the new string number will be active. See the following table for switch settings and their string allocation:

S1 / 1:	S1 / 2:	S1 / 3:	S1 / 4:	String Number:
off	off	off	off	1
on	off	off	off	2
off	on	off	off	3
on	on	off	off	4
off	off	on	off	5
on	off	on	off	6
off	on	on	off	7
on	on	on	off	8
off	off	off	on	9
on	off	off	on	10

**Status LED:**

When the green LED on the EQUALINK\_CSxxx Current Sensor is flashing it indicates that power is available. The green LED is constantly on if the device was detected by the EQUALINK Webmanager and measuring values are transferred (normal operation). If the communication to the EQUALINK Webmanager is interrupted, the LED will start flashing after 60 seconds to indicate that there is communication problem.

**Diagram of EQUALINK\_CSxxx Current Sensor Type CS II (Build Year 2009):**

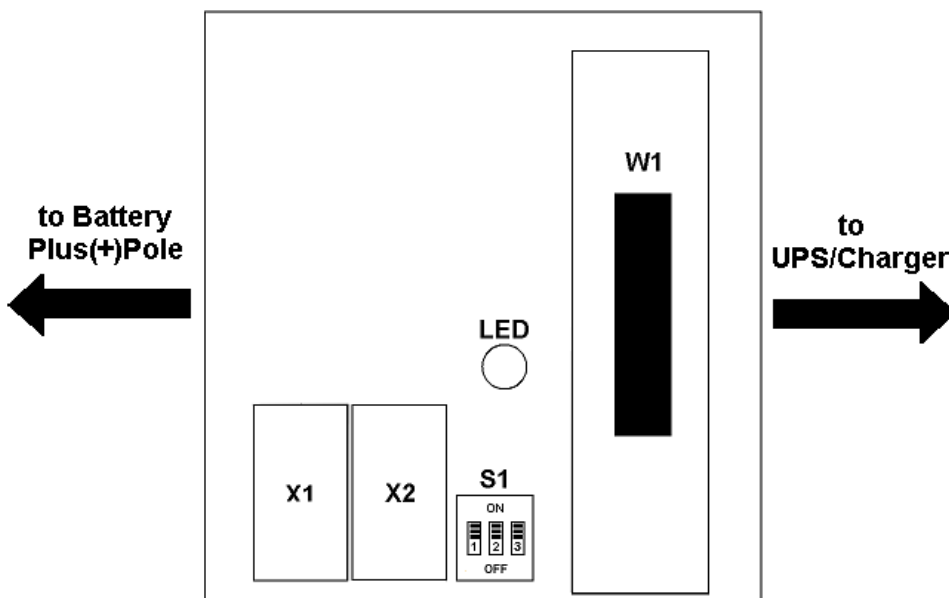

Figure 80: EQUALINK\_CSxxx Typ CS\_II

**Diagram of EQUALINK\_CS III xxx Current Sensor Type CS III (Build Year 2010):**



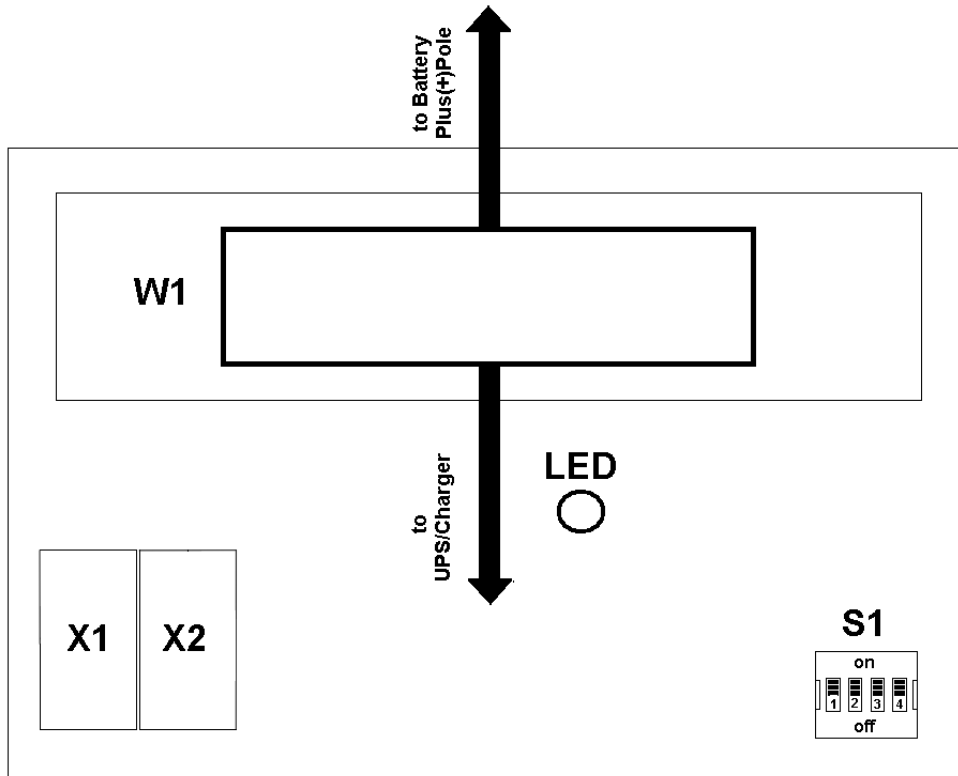

Figure 81: EQUALINK\_CSxxx Typ CS\_III

**i** Attention: If EQUALINK\_CSxxx Current Sensors will be refitted, please note, that the power supply of the EQUALINK BUS CONVERTER or EQUALINK WEBMANAGER II is a controlled (stabilized) 12V power supply. The feeding has to be stable (+/- 0.5V)!

### 9.5 EQUALINK Control Cabinets Type 1 – 4

The EQUALINK Control Cabinets are ready to install cabinets with up to 6 EQUALINK WEBMANAGERS and the accordant power supplies, so that only one power feed and one network cable is required. The cabinets simplify the assembling and provide through their integrated displays into the front door even into closed state a quick overview of the system.

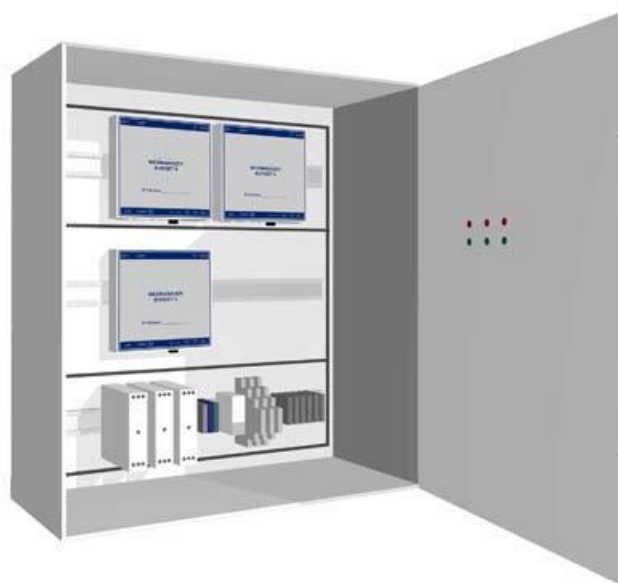

Figure 82: EQUALINK Control Cabinet

## 10. EQUALINK FAQ

In this chapter we describe well known problems you may encounter during installation or configuration of EQUALINK. We regularly update this chapter as a feedback to solutions for well known problems.

### Frequently Asked Questions

**Problem: EQUALINK modules are not able to address or not available.**

**Solution:** If you have problems with the addressing of the modules, the problem might be a not well-fitting B2BCRJxxx cable. Disconnect the B2BCRJxxx cable out of the module with the address **prior** of the incorrect one and check if the 4 metal reeds are located at the same level into the body of the RJ10 connector. If not (e. g. because of oblique connection of the cable), please correct it while pulling down the metal reeds until they are located at the same level and so the pressure at the EQUALINK cable is equal. Furthermore you should change the B2BCRJxxx cable, because it might be incorrect too and thus the metal reeds are not located right. In case of doubt please change both the module and the cable, to limit the source of the defect.

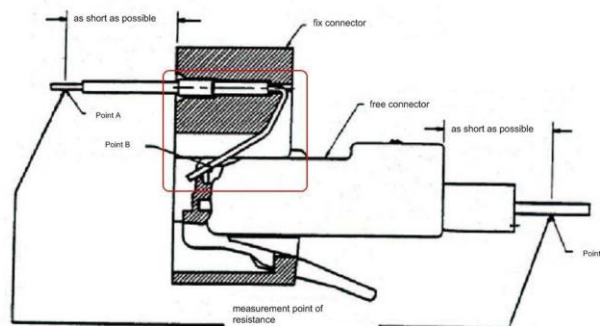

**Problem: EQUALINK modules are not able to address or not available.**

**Solution:** The B2BCRJxxx cable is another source of defect. Please check visually if the 4 wires are in sight at the plug. If not, please change the cable, because an adjustment is not possible.

**Problem: The battery will be discharged, if EQUALINK is connected.**

**Solution:** If the **EQUALINK modules** from **hardware revision 1.4** will not be polled from the EQUALINK Web manager for a longer time (between 9 to 16 hours), the EQUALINK modules will switch into "Sleep Mode", to reduce the power consumption (the remaining consumption is 6-8mA per module). We advise that a long off-time (more than 2 months) might be enough to discharge the batteries. We recommend, for a longer off-time, that you disconnect the modules from the batteries, until the battery will be able to reconnect to the charger. If EQUALINK modules from hardware revision 1.4 and higher are in the "Sleep Mode", they need up to 5 minutes to "awake". That means the EQUALINK Web manager needs to send signals for a longer time to them, until the modules will be back in operation mode, displayed by their LEDs. The duration of the process depends of the amount of batteries in the string (generally between 1 to 5 minutes). You can speed up the process if you disconnect the EQUALINK modules from the measuring cables for a short time and reconnect them. After that the EQUALINK Web manager will be back in operating mode.

EQUALINK modules prior of hardware revision 1.4 possess no "Sleep Mode", so that an inclusion is allowed with disconnected EQUALINK modules only.

**Problem: The EQUALINK module displays less voltage clearly, than the truly value of the battery.**

**Solution:** This suggests that a broken EQUALINK measuring cable. Check the measuring cable on a second battery. If the failure is now not apparent anymore, then replace the EQUALINK measuring cable.

**Problem: The EQUALINK modules are not able to address at the end of a string.**

**Solution:** Take the modules at the beginning of the string or take the EQUALINK Web manager and the EQUALINK Converter near the appropriate modules to remove cable lengths that are too long. If you are now able to address the modules, then the EQUALINK bus cable is too long and an EQUALINK Splitting Box should be inserted or it is required to optimize the cabling, to reduce the total length of the EQUALINK bus cable.

**Problem: Communication problems to the EQUALINK modules.**

**Solution:** It could be last 45 seconds per module, until the "EQUALINK Communication Lost" alarm will be triggered.

**Problem: EQUALINK modules signal system alarm or false alarm.**

**Solution 1:** You are using the wrong power supply or the power supply is without transformer. The power supply which is a known problem: MW (Mean Well) GS18E15-P1J/ 13-16V / 1, 38-1,12A

**Solution 2:** The power supply is too weak. The default scope of delivery is a 500mA power supply (for up to 100 EQUALINK modules). From 120 modules you need an 800mA power supply, 1A up to 200 modules, and 1.4A up to 256 modules. You need 5mA per EQUALINK module.

**Problem: All EQUALINK modules head into addressing mode.** You are able to get the first module via pressing of the addressing button from the addressing mode (red fast flashing) into normal condition (green constantly), but the address will not be assumed, the response into the web-browser of "refresh" will not be send and the modules remain on address 1.

**Reason:** At least one EQUALINK bus-cable is damaged at PINs 3 and 4 (address return line).

**Solution:** Act step-by-step, at first exchange the EQUALINK bus-cables from module 1 to 10 and re-address them. If okay, then the next 10 modules etc., until the fault will occur.

**Problem:** EQUALINK shows red status LED communication lost. Why does it take so long before such an event is visible on the EQUALINK screen?

**Solution:** If communication breakdowns to the EQUALINK modules occur, it will take 45 seconds per module, until the EQUALINK Communication Lost "warning" will be displayed

**Problem:** EQUALINK modules or sensors fall off; adhesive glue/bonding is not strong enough

**Solution:** This is a problem which is mostly caused by too much tension on the EQUALINK module or temperature sensor due to the EQUALINK measuring cable or the position of the EQUALINK module at the battery (mostly if EQUALINK module or temperature sensor is not mounted on top of battery). If you cannot release the tension on the cables or change the position of the EQUALINK module so that gravity cannot detach the modules, then you have to additionally use a glue to fix the sensors onto the battery.

For cleaning the battery cabinet please use only solvents recommend by the battery manufacturer. If you cannot find any of such recommendations at your battery manufacturer, we recommend using a solvent like HOPPECKE "Battery Clean" or something similar.

To affix the EQUALINK Modules and temperature sensors with glue, we recommend using a high quality silicone rubber compound.

**Problem:** The EQUALINK WEBMANAGER does not find all modules and starts extremely slow. After the start-up has finished, the EQUALINK Status page shows at one (or more) modules a BLUE Status Icon and no measurement data, while on others it shows a RED Status Icon, also without measurement data (see Screenshot below, left):

String 1					
Module No.	Volt. [V]	Temp. [°C]	Resist. [mΩ]	Equalize (ON)	State
1	13.99	21.1	23.00		
2	13.05	21.0	23.02		
3	14.21	20.0	23.64		
4	13.85	21.0	21.11		
5	n.a.	n.a.	n.a.		
6	14.21	20.0	20.22		
7	13.27	20.6	24.57		
8	13.73	20.9	24.54		
9	14.17	21.1	24.08		
10	12.88	19.5	24.25		
11	14.56	21.1	23.48		
12	12.97	21.0	22.37		
13	13.01	21.8	23.31		
14	13.77	21.0	23.19		
15	14.31	20.7	23.93		
16	13.24	21.0	22.49		
17	14.07	20.6	23.34		
18	13.21	20.9	23.68		
19	13.01	20.7	20.64		
20	n.a.	n.a.	n.a.		
21	12.96	20.5	22.73		
22	13.09	20.8	23.20		
23	12.99	20.6	23.94		
24	12.98	20.7	23.48		
25	13.01	20.8	23.13		
26	13.05	20.2	24.09		
27	12.98	20.4	22.94		
28	13.24	19.8	24.49		
29	13.43	20.5	23.04		
30	13.42	19.5	22.78		
31	13.41	21.0	22.95		
32	13.43	20.2	22.83		

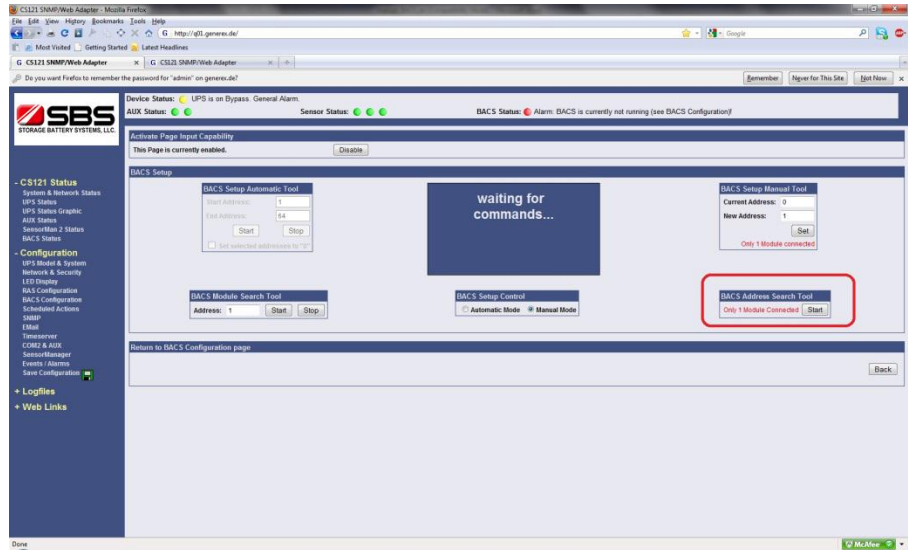

**Solution:** This shows that there are at least 2 modules with a double address in the EQUALINK Bus. In the screenshot above, the double address is at number 20. Disconnect all EQUALINK modules from the EQUALINK Bus and connect only the modules (one after the other), which are shown with a RED Status Icon. Check now with the EQUALINK SETUP page, Manual Mode, function “EQUALINK Address Search Tool” (marked red in the EQUALINK CONFIGURATION screen above, right side), which address the connected module has. If the address is wrong (double), correct it with the function “EQUALINK Setup Manual Tool” in the same EQUALINK CONFIGURATION page.

**Problem:** After the reboot of the EQUALINK WEBMANAGER, unreachable EQUALINK C-Modules are displayed during initialization.

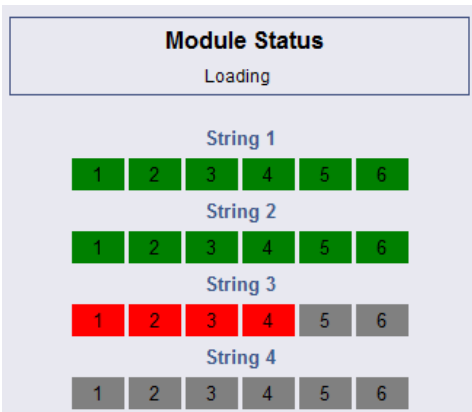

**Solution:** Check the wiring of the “Unreachable Modules” (like the above example 13 to 24).

**Problem:** The access to the EQUALINK data with the EQUALINK Viewer is not possible. An error occurs, that a password was not set and you can not click the password menu button.

**Solution:** This might be a problem with the Toshiba Password Manager. It is required that this manager is disabled for the operation with the EQUALINK Viewer.

**Problem:** The EQUALINK status displays an “Equalisation Error” for an EQUALINK-C-Module.

**Solution:** This alarm occurs if an EQUALINK module delivers more Balancing power than designated. This is a fault of the module. It is necessary to exchange this module to avoid more damages.

**Problem:** You can not select a value for the voltage difference into the EQUALINK Configuration menu "EQUALINK Module & Alarm Settings".

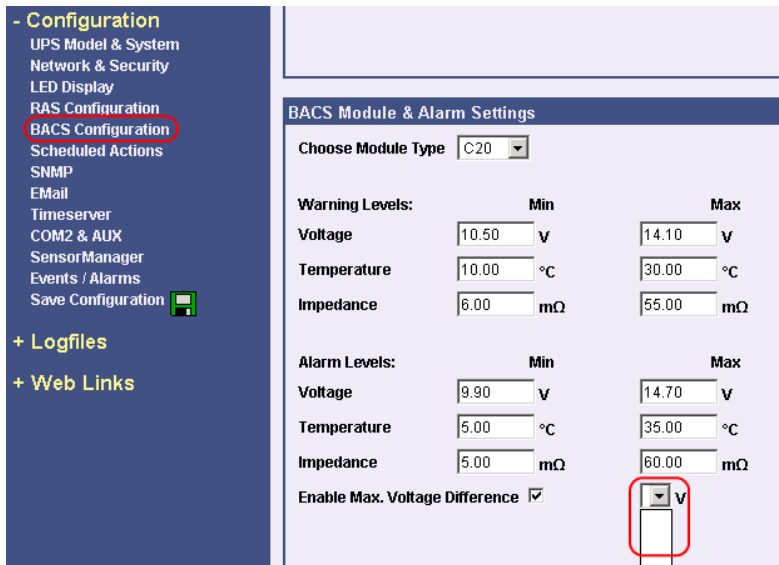

**Solution:** The web-browser versions Internet Explorer 8.0 and Mozilla Firefox 3.5 and higher are required.

**Problem:** Battery exchange at an EQUALINK system

**Solution:** If batteries are damaged and have to be exchanged and therefore older batteries will remain into the system, please note, that the new batteries should be implemented fully charged or a discharge on all batteries has to be executed to start a boost charge on all batteries. Reason: Batteries, which are not fully charged, will be charged through the BALANCING extra, but this will be done with a few charging current only. This may result in a not optimal removal of sulfatings and a not fully charged battery. A discharge on all batteries will cause a strong charging phase afterwards so that Balancing can perform better on this new battery. The new battery will reach a full charge shortly and will stay in this state through the BALANCING.

**Problem:** The EQUALINK battery history will be overwritten at EQUALINK devices.

**Solution:** The memory is dynamic and its logging period depends on the amount of batteries and the amount of occurring alarms or dischargings. If more than 20MB or 365 days are reached, the old data will be overwritten. **Please save and delete the EQUALINK log files regularly (see chapter 6.4).**

**Problem:** Error code of the EQUALINK C-Module from REV. 3, date of manufacture 10/2011: During insertion of an EQUALINK C-Module no LED is shining (sleep mode). As recently as the EQUALINK bus is active, the EQUALINK C-Modules awake and display, depending on the address status, a slow red flashing LED or a green LED (static if polling into the bus, flashing if no polling into bus). If the EQUALINK C-Modules get their first bus signal and awake during a new installation, it is required that they all display a slow red flashing LED (address = 0). If a LED displays a static red LED, then an error occurred at the temperature sensor.



**Solution:** Open the module and check the temperature sensor into the housing (with measuring device, resistance between the poles should be 10kohm for the status OK, 0kohm is damaged).

Other cause of error: Wrong assembling of the temperature sensor (see following figure) or contact problems with the main plate via gold contact.

C Module with a defective gold contact at temperature sensor connector

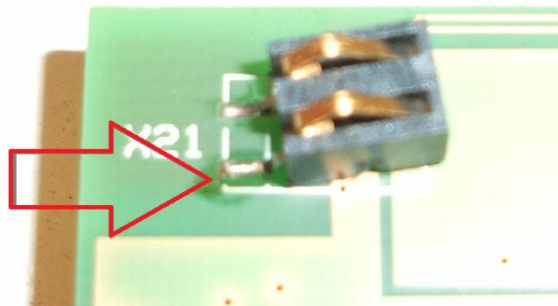

**Problem:** The red LED at the EQUALINK C-Module is shining steady.

**Solution:** That is an indication of a damaged temperature sensor or that the sensor got no contact to the board or the detector itself is damaged (normal operation of the LED, if okay and address "0" = red flashing).

## Appendix

### A. EQUALINK Bus Cabeling – Technical Description and Examples

The EQUALINK System uses special bus cables in different lengths (Product No. B2BCRJxxxx) to connect the EQUALINK C-Modules together. To provide failure-free operation the bus cables should be short as possible and not be install parallel to the power cables of the load. At battery systems with more than 70 batteries it's necessary to use a SPLITTINGBOX. With a SPLITTINGBOX it is possible to split the bus cabeling radial with a certain number of modules. See detailed examples below in this description. The SPLITTINGBOX is optionally available and is not included in the shipment of the EQUALINK WEBManager Starter Kits.



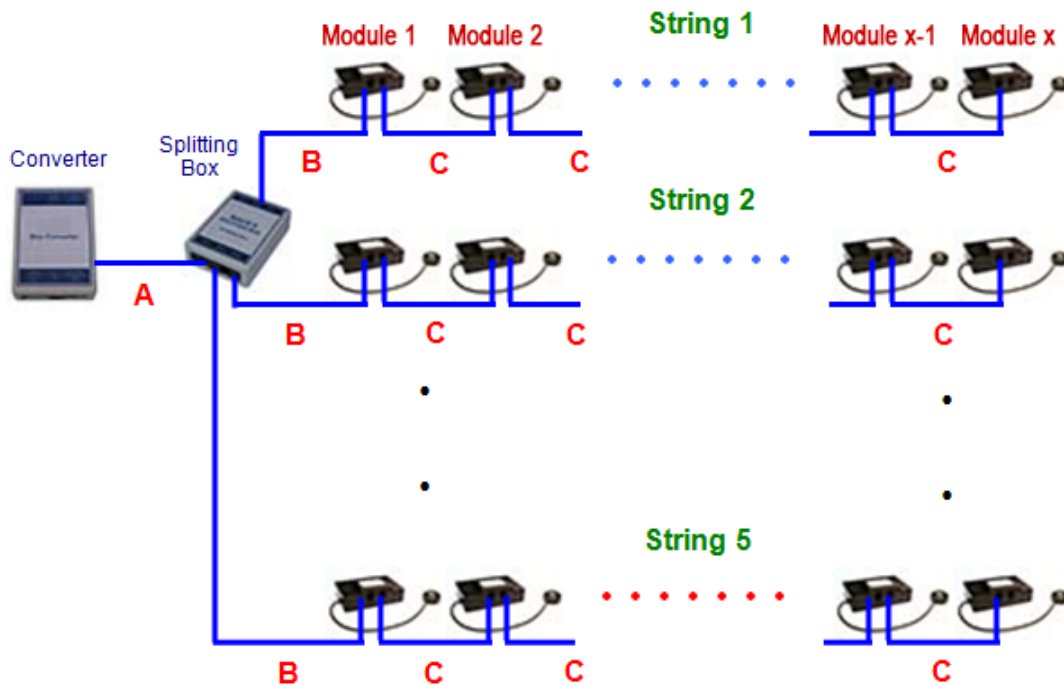

The picture above shows the maximum of 255 EQUALINK modules for one EQUALINK WEBMANAGER. The maximum number of modules per string depends on the sum of the bus cable length between the modules (C), the length of the bus cable from the SPLITTINGBOX to the first module (B) and from the BusConverter to the SPLITTINGBOX (A).

Here “**String**” does **not** mean the battery string but rather the bus string of the EQUALINK modules. This means for example a battery string with 136 pcs. of 2V blocs will be separate in more bus strings which will all be connected to the SPLITTINGBOX. The maximum number of modules per bus string is declared with (x) and specified in the following table. If there are fewer batteries than pictured above, only the number of bus strings will reduce, the number of the modules (x) per string will not change. At the total number of the modules less than (x) only one bus string will be build up and so the SPLITTINGBOX is not necessary.

The EQUALINK bus cables are available in lengths of 25cm, 40cm, 70cm, 1.5m, 3m, 5m and 10m. The lengths of 25cm and 40cm are designed for the connections between the modules and the higher lengths to connect the battery levels (70cm and 1.5m) together and also for the connection from the BUSCONVERTER to the SPLITTINGBOX or to the first module (1.5m, 3m, 5m and 10m).

Possibility configurations					
total quantity modules	length buscable C	length buscable A	length buscable B	min. quantity of busstrings	max. quantity of modules per string (x)
1 – 50	25cm	< 5m	1,5m	1 <sup>2</sup>	50
1 – 50	25cm	10m	1,5m	1 <sup>2</sup>	50
1 – 50	25cm	15m	1,5m	1 <sup>2</sup>	50
1 – 50	40cm	< 5m	1,5m	1 <sup>2</sup>	50
1 – 50	40cm	10m	1,5m	1 <sup>2</sup>	50
1 – 50	40cm	15m	1,5m	1 <sup>2</sup>	50
50 – 100	25cm	< 5m	1,5m	2 <sup>2</sup>	50
50 – 100	25cm	10m	1,5m	2 <sup>2</sup>	50
50 – 100	25cm	15m	1,5m	2 <sup>2</sup>	50
50 – 100	40cm	< 5m	1,5m	2 <sup>2</sup>	50
50 – 100	40cm	10m	1,5m	2 <sup>2</sup>	50
50 – 100	40cm	15m	1,5m	2 <sup>2</sup>	50
100 – 150	25cm	< 5m	1,5m	3 <sup>2</sup>	50
100 – 150	25cm	10m	1,5m	3 <sup>2</sup>	50
100 – 150	25cm	15m	1,5m	3 <sup>2</sup>	50
100 – 150	40cm	< 5m	1,5m	3 <sup>2</sup>	50
100 – 150	40cm	10m	1,5m	3 <sup>2</sup>	50
100 – 150	40cm	15m	1,5m	3 <sup>2</sup>	50
150 – 200	25cm	< 5m	1,5m	4 <sup>2</sup>	50
150 – 200	25cm	10m	1,5m	4 <sup>2</sup>	50
150 – 200	25cm	15m	1,5m	4 <sup>2</sup>	50
150 – 200	40cm	< 5m	1,5m	4 <sup>2</sup>	50
150 – 200	40cm	10m	1,5m	4 <sup>2</sup>	50
150 – 200	40cm	15m	1,5m	4 <sup>2</sup>	50
200 – 256	25cm	< 5m	1,5m	5 <sup>2</sup>	51
200 – 256	40cm	< 5m	1,5m	5 <sup>2</sup>	51

<sup>2</sup> The quantity of strings could be increased if necessary, but verify that the maximum quantity of modules per string will not be exceeded. This could be accomplished by evenly distributed modules to single bus strings from the SPLITTINGBOX. If you have more than 5 bus strings you have to use a second SPLITTINGBOX.

## B. Hoppecke Monitoring Screws

**Advice:** HOPPECKE offers a monitoring screw set for their batteries (HOPPECKE order number: 7142000421). This set is designed for voltage measuring only. To make this screw set also usable for EQUALINK with impedance measuring, you have to replace the original 8mm screw against a **10mm V2A screw** and washer to ensure a firm connection to the HOPPECKE battery monitoring screw.

If you use the standard screw with 8mm there is the potential problem that the plastic coat gets softer over the years (or through temperature change) so that the screw is no longer tight. This will have an effect on the impedance measurement and may cause false alarms.

Please note for replacing the original HOPPECKE screw 8mm you may use our Product code "EQUALINK\_HOP" which consists of:

- EQUALINK eyelet M5
- Spring washer (A5 V2A)
- M5 x 10mm hexagon pole screw (V2A)

Tightening torque: 5mm screws with 5 – 7 Nm

We recommend that any isolation plastic caps get changed for a proper cable installation.



In this example we recommend to arrange a hole from above. The tension of the plastic cap should not be affected and the grip of the monitoring screws is ideal.

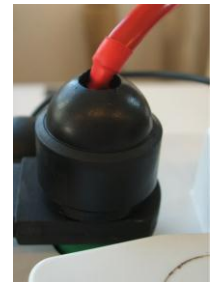

### Quick Guide Cable Assembling at Rack Batteries

String the EQUALINK measuring cable between the batteries backwards. The EQUALINK module should be mounted at the top of the battery (see fig. 60). The EQUALINK measuring cable should be passed around the covering, so that no voltage lead pieces are able to jut out of the cap.

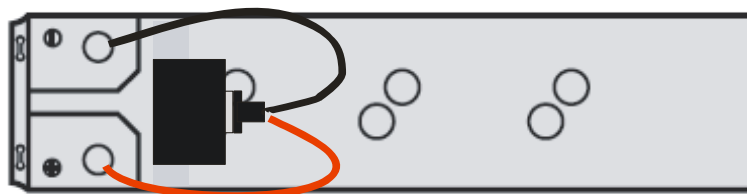

Figure 83: Cable Assembling at Rack Battery

## C. Installation Instruction External Temperature Sensor from EQUALINK Rev. 3.x

The EQUALINK module from Rev.3.x up has a temperature sensor for detecting the battery temperature which is integrated on the bottom side of the housing. If the EQUALINK module is mounted on the surface of the battery this temperature sensor is directly contacted to them.

If it is not possible to mount the EQUALINK module Rev.3.x directly on the surface of the battery or you want to measure the temperature on another position you can use the optional external EQUALINK temperature sensor (EQUALINK\_TS). The external EQUALINK temperature sensor (EQUALINK\_TS) is at the end of a 23cm long wire and will be connected to the already existing pin on the EQUALINK module Rev.3.x board. To connect the external EQUALINK temperature sensor (EQUALINK\_TS) please follow the instruction below:

- Disconnect all measuring and bus cables from the EQUALINK module
- Open the housing by levering the marks with a screwdriver carefully:



- Quarry out the rated break point carefully (forceps, long-nosed pliers, etc.):



- Connect the plug of the temperature sensor to the pin on the EQUALINK module Rev.3.x Board:

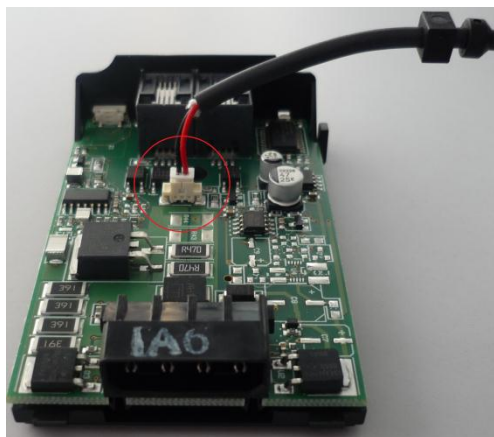

- Push the mains lead cleat in the side cutout of the housing:



- Stick the upper and lower part of the housings together:



The external temperature sensor (EQUALINK\_TS) will be detected automatically at the next start of the EQUALINK module and is active. The integrated temperature sensor will be deactivated automatically.

#### D. Storage of the EQUALINK Webmanager Configuration

After you have finished your configuration, we recommend to store the configuration files. Via the “Save Configuration” menu and “Backup CS121 Configuration”, you can store the common UPS configuration file (upsman.cfg) and via “Backup EQUALINK Configuration, you can store the EQUALINK configuration file (Equalink.ini).

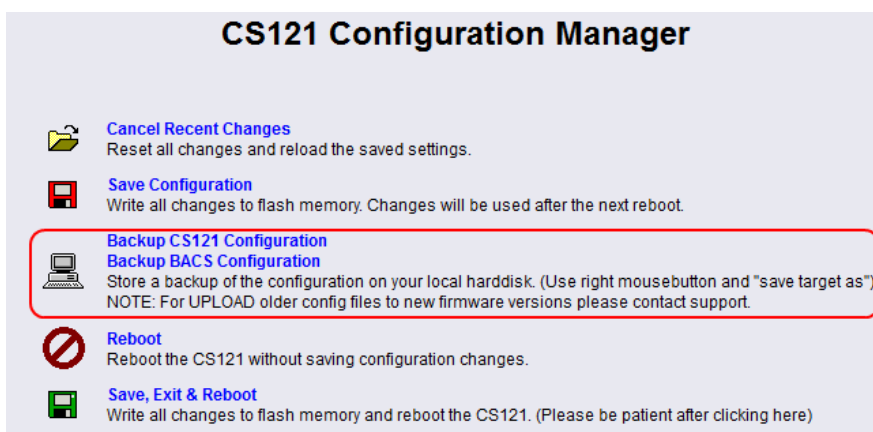

Figure 84: Backup Configuration

If you want to update the EQUALINK Webmanager firmware version and it might not be able to keep your old configuration, you can transfer the stored files via FTP into the flash folder of the EQUALINK Webmanager. Enter the following into a web-browser:

ftp://IP address of the EQUALINK II Webmanager Budget/flash

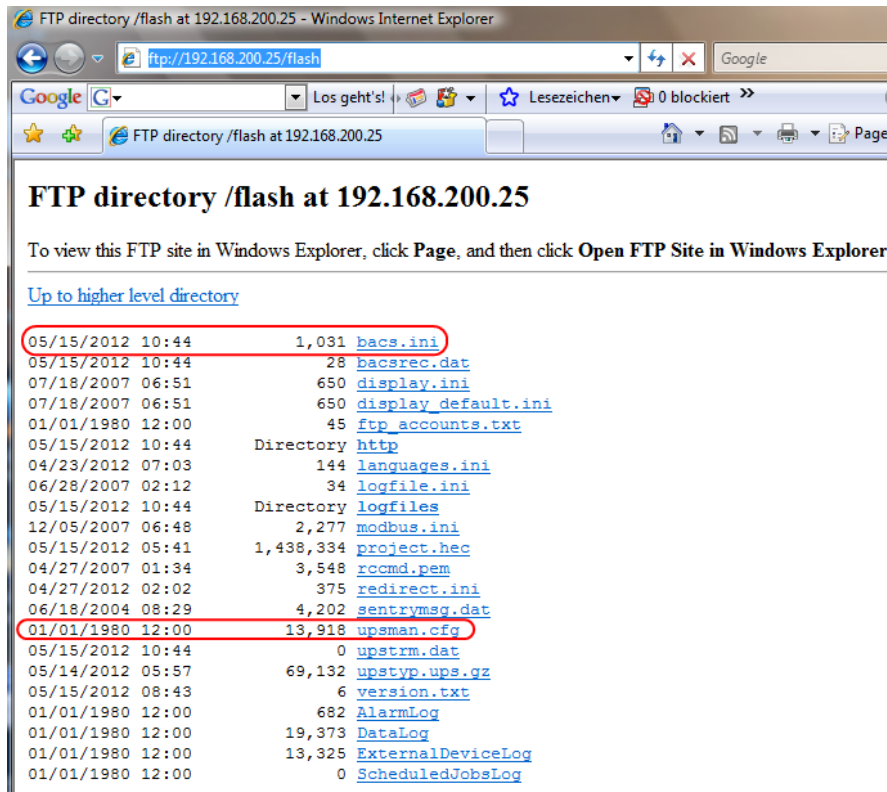

Figure 85: EQUALINK Web manager FTP-Connection

## E. Updating of the EQUALINK Firmware

You should check if there are any firmware updates for your EQUALINK WEBMANAGER available on a regular basis. To find out your actual EQUALINK firmware version see “System & Network Status”.



Figure 86: Web Interface System Information

Click the “Firmware Update” button in the menu “Web Links” to check if an update is available.



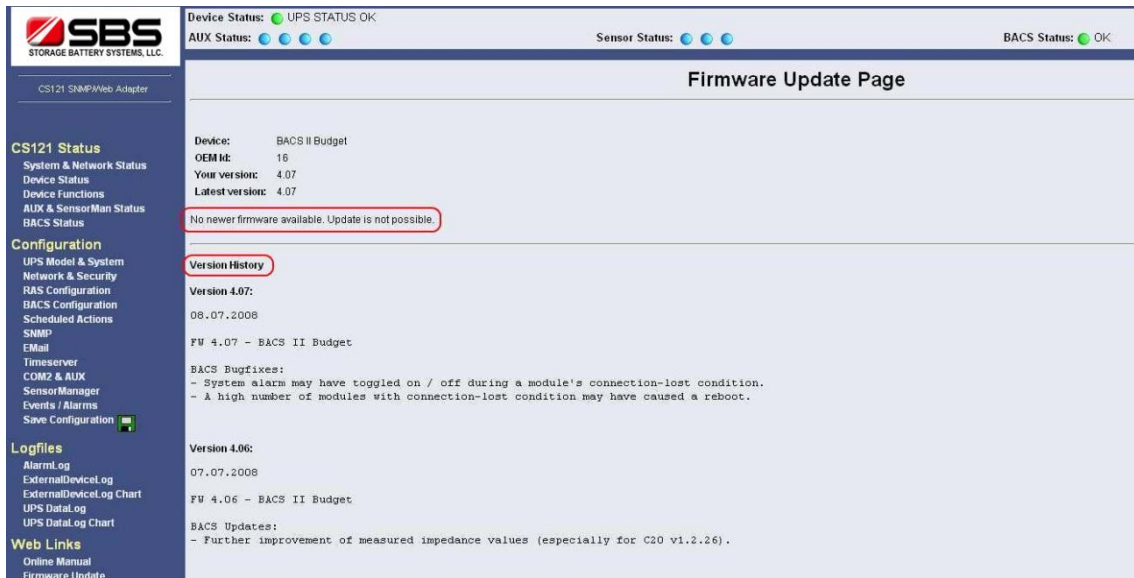

Figure 87: Web Interface Firmware Update Page

In the main frame appears the message “No newer firmware available...”, which means the EQUALINK Webmanager is up to date. You can see in the version history what changes were made in the last update.

If you read a message in green letters like “Feature upgrade only”, then you may upgrade if any of the features look important for you, but you may also keep the system running on the actual firmware level. At any red message e.g. “Critical update” or similar text, please download and update your system as soon as possible.

Update is an easy, automated process which uses the local network to update your EQUALINK WEBAMANGER.

If you update any EQUALINK Web manager and EQUALINK battery data is found, you receive a warning message and you may download and save these files during the update process.

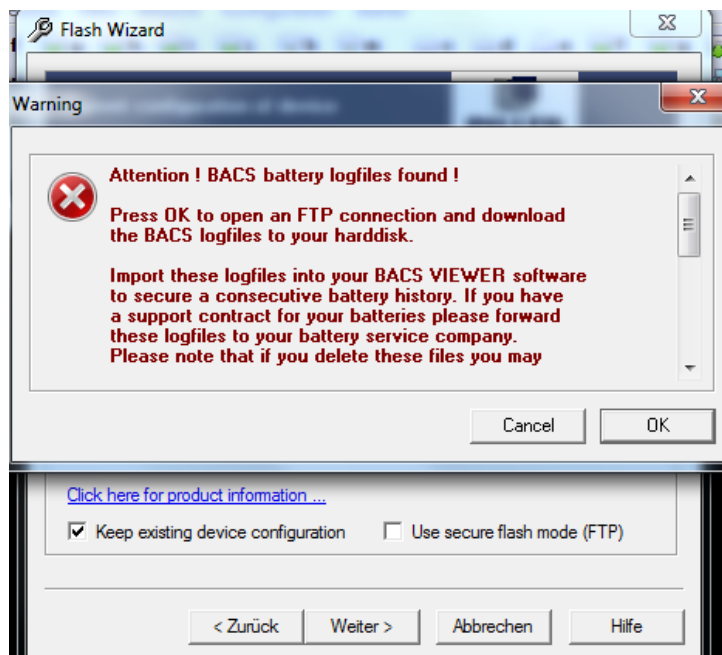

Figure 88: Firmware Update Warning

If you have already downloaded these files recently, then you may ignore this message and click CANCEL to continue the update without saving EQUALINK history files.





**Advice:** Please note, that you may lose the battery guarantee if you delete these EQUALINK files. Please check your warranty conditions for your batteries if such an EQUALINK history is part of the warranty agreement. Besides downloading the EQUALINK log files through the EQUALINK VIEWER, you may also use any FTP client at port 21 (TCP) to download the files manually.

To import such manually downloaded files into your EQUALINK VIEWER Software please check “Import EQUALINK Data” in this manual.

## F. Storage of Batteries with EQUALINK

If you want to store batteries with EQUALINK modules, please be aware that this increases the natural self-discharge of batteries. If EQUALINK modules hardware revision 1.4 are polled from the EQUALINK WEBMANAGER for a longer time (between 9 to 16 hours), these EQUALINK modules will switch into a “Sleep Mode”, to reduce the power consumption (the remaining consumption in sleep mode is 6-8mA per module). Please note that at a long off-time (more than 2 months) even this small consumption might be enough to discharge the batteries. We recommend, at a long off-time, to disconnect the modules from the batteries, until the batteries will be able to reconnect to the charger. If EQUALINK modules from hardware revision 1.4 and higher are in the “Sleep Mode”, they need up to 5 minutes to “wake up”. That means the EQUALINK WEBMANAGER needs to send signals for a long time to them, until the modules will be back in operation mode, displayed by their LEDs. The duration of the process depends of the amount of batteries in the string (generally between 1 to 5 minutes). You can speed up the process if you disconnect the EQUALINK modules from the measuring cables for a short time and reconnect them. After that the EQUALINK WEBMANAGER will be back in operating mode.

EQUALINK modules prior to hardware revision 1.4 do not have a “Sleep Mode”. These modules have to be removed from the power source to avoid deep discharges if the battery charger gets switched off.

If you want to store batteries, or the battery charger is disconnected for a longer time, please note that you should also disconnect the EQUALINK WEBMANAGER.

## G. BACS Events/Alarms Description

Event	Description
BACS Started	Battery monitoring started
BACS Discharging Phase	Battery discharging
BACS Charging Phase	Battery charging
BACS System Alarm	Module communication is lost and the system is in Alarm mode! React immediately!
BACS System Alarm off	Module communication restored
BACS Voltage High Alarm	BACS Voltage High Alarm
BACS Voltage High Alarm off	BACS Voltage High Alarm reset
BACS Voltage Low Alarm	BACS Voltage Low Alarm
BACS Voltage Low Alarm off	BACS Voltage Low Alarm reset
BACS Temperature High Alarm	BACS Temperature High Alarm
BACS Temperature High Alarm off	BACS Temperature High Alarm reset
BACS Temperature Low Alarm	BACS Temperature Low Alarm
BACS Temperature Low Alarm off	BACS Temperature Low Alarm reset
BACS Resistor High Alarm	BACS Resistor High Alarm
BACS Resistor High Alarm off	BACS Resistor High Alarm reset
BACS Resistor Low Alarm	BACS Resistor Low Alarm
BACS Resistor Low Alarm off	BACS Resistor Low Alarm reset
BACS Voltage Diff High Alarm	Voltage difference between single batteries to high
BACS Voltage Diff High Alarm off	Voltage difference between single batteries okay

BACS Battery Breaker open Alarm	Battery breaker open, no battery protection active!
BACS Battery Breaker open Alarm off	Battery breaker closed
BACS Equalisation Error Alarm	Equalisation error
BACS Equalisation Error Alarm off	Equalisation error reset
BACS Voltage High Warning	BACS Voltage High Warning
BACS Voltage High Warning off	BACS Voltage High Warning reset
BACS Voltage Low Warning	BACS Voltage Low Warning
BACS Voltage Low Warning off	BACS Voltage Low Warning reset
BACS Temperature High Warning	BACS Temperature High Warning
BACS Temperature High Warning off	BACS Temperature High Warning reset
BACS Temperature Low Warning	BACS Temperature Low Warning
BACS Temperature Low Warning off	BACS Temperature Low Warning reset
BACS Resistor High Warning	BACS Resistor High Warning
BACS Resistor High Warning off	BACS Resistor High Warning reset
BACS Resistor Low Warning	BACS Resistor Low Warning
BACS Resistor Low Warning off	BACS Resistor Low Warning reset
BACS General Alarm	General failure/alarm, check website BACS for details
BACS General Alarm off	General failure/alarm reset

## H. BACS II SNMP MIB Overview

Variable	OID
<b>BACSSettings</b>	1.3.6.1.2.1.33.5.1
BACSModuleTypes	1.3.6.1.2.1.33.5.1.1
BACSNumStrings	1.3.6.1.2.1.33.5.1.2
BACSNumBatteries	1.3.6.1.2.1.33.5.1.3
BACSBattCap	1.3.6.1.2.1.33.5.1.4
BACSLogRate1	1.3.6.1.2.1.33.5.1.5
BACSLogRate2	1.3.6.1.2.1.33.5.1.6
BACSResistPollRate	1.3.6.1.2.1.33.5.1.7
BACSBattAlarmLevel	1.3.6.1.2.1.33.5.1.8
BACSBattWarnLevel	1.3.6.1.2.1.33.5.1.9
BACSTemperatureLowAlarm	1.3.6.1.2.1.33.5.1.10
BACSTemperatureHighAlarm	1.3.6.1.2.1.33.5.1.11
BACSVoltageLowAlarm	1.3.6.1.2.1.33.5.1.12
BACSVoltageHighAlarm	1.3.6.1.2.1.33.5.1.13
<b>BACSObjects</b>	1.3.6.1.2.1.33.5.2
BACSStatus	1.3.6.1.2.1.33.5.2.1
BACSNumModules	1.3.6.1.2.1.33.5.2.4
BACSModuleTable	1.3.6.1.2.1.33.5.2.5
BACSModuleEntry	1.3.6.1.2.1.33.5.2.5.1
BACSModuleIndex	1.3.6.1.2.1.33.5.2.5.1.1
BACSModuleVoltage	1.3.6.1.2.1.33.5.2.5.1.2
BACSModuleTemperature	1.3.6.1.2.1.33.5.2.5.1.3
BACSModuleBypass	1.3.6.1.2.1.33.5.2.5.1.4
BACSModuleResistance	1.3.6.1.2.1.33.5.2.5.1.5
BACSModuleState (see definition below)	1.3.6.1.2.1.33.5.2.5.1.6
<b>BACSAlarms</b>	1.3.6.1.2.1.33.5.3

BACSAAlarmPresent	1.3.6.1.2.1.33.5.3.1
BACSAAlarmTable	1.3.6.1.2.1.33.5.3.2
BACSAAlarmEntry	1.3.6.1.2.1.33.5.3.2.1
BACSAAlarmID	1.3.6.1.2.1.33.5.3.2.1.1
BACSAAlarmDescr	1.3.6.1.2.1.33.5.3.2.1.2
BACSAAlarmTime	1.3.6.1.2.1.33.5.3.2.1.3
BACSWellKnownAlarms	1.3.6.1.2.1.33.5.3.3
BACSAAlarmSystemError	1.3.6.1.2.1.33.5.3.3.1
BACSAAlarmResistWarn	1.3.6.1.2.1.33.5.3.3.2
BACSAAlarmResistAlarm	1.3.6.1.2.1.33.5.3.3.3
BACSAAlarmVoltage	1.3.6.1.2.1.33.5.3.3.4
BACSAAlarmTemperature	1.3.6.1.2.1.33.5.3.3.5
<b>BACSTraps</b>	1.3.6.1.2.1.33.5.4
BACSTrapAlarmEntryAdded	1.3.6.1.2.1.33.5.4.1
BACSTrapAlarmEntryremoved	1.3.6.1.2.1.33.5.4.2

**BACS Module State Definition:**

Event	Decima
Ok	0
General Alarm	1
Communication Lost	2
Voltage High	4
Voltage Low	8
Temperature High	16
Temperature Low	32
Resistor High	64
Resistor Low	128
Equalisation Error (Modul EQ defekt)	256
Voltage Warn High	512
Voltage Warn Low	1024
Temperature Warn High	2048
Temperature Warn Low	4096
Resistor Warn High	8192
Resistor Warn Low	16384

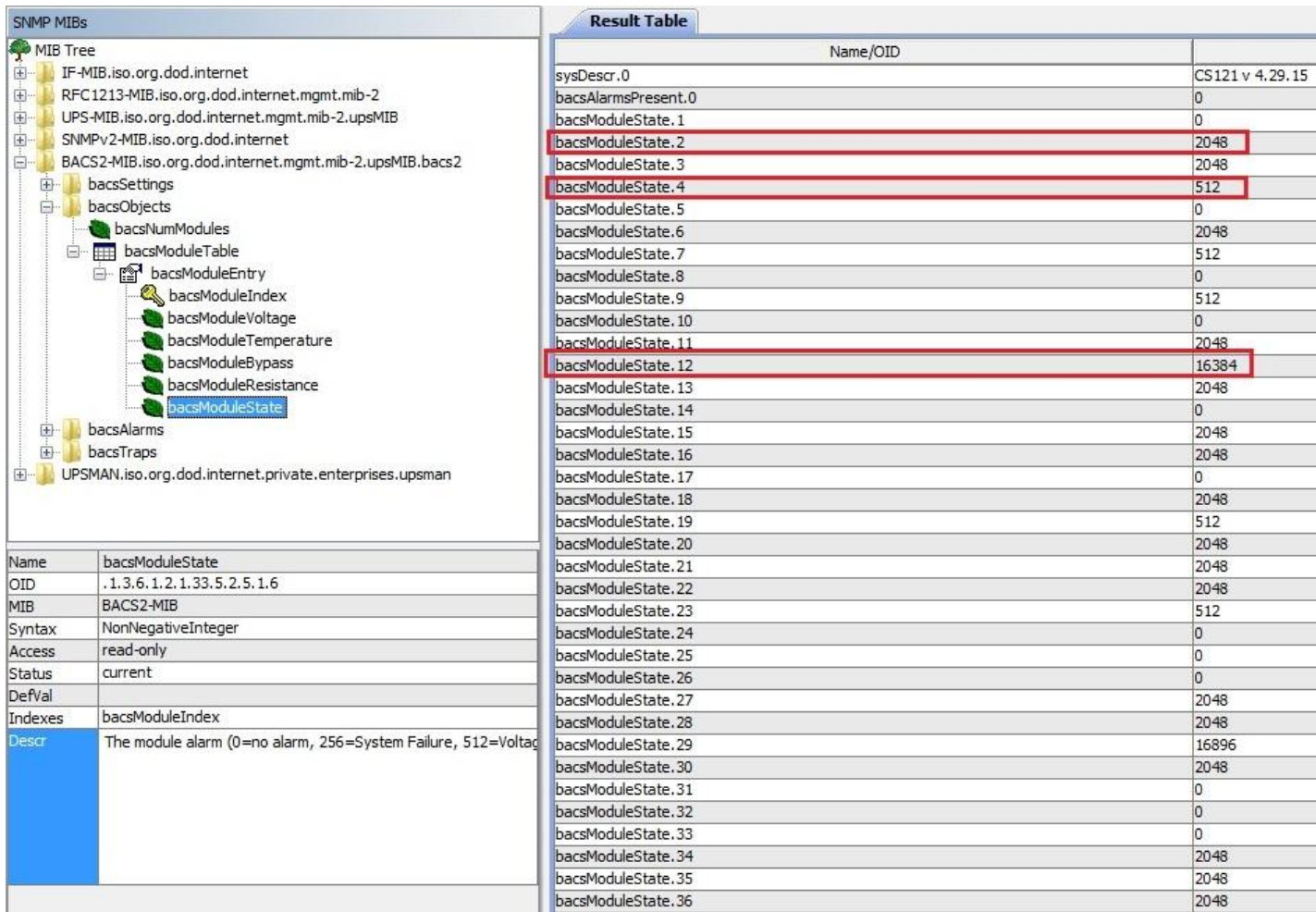

Figure 89: BACS SNMP Polling

**BACS Status Definition:**

Event	Decimal
BACS_STATE_NONE	0
BACS_STATE_RUNNING	1
BACS_STATE_CONNECTED	2
BACS_STATE_MODULE_LOST	4
BACS_STATE_DISCHARGING	8
BACS_STATE_CHARGING	16
BACS_STATE_DISCHARGING_STOPPED	32
BACS_STATE_FLOAT_CHARGING	64
BACS_STATE_EQUALISATION	128
BACS_STATE_SYSTEM_FAILURE	256
BACS_STATE_VOLTAGE_OUTOFRANGE	512
BACS_STATE_TEMPERATURE_OUTOFRANGE	1024
BACS_STATE_RESISTOR-OUTOFRANGE	2048
BACS_STATE_MODULE-ADDRESSING	4096
BACS_STATE_MODULE-SEARCHING	8192
BACS_STATE_MODULE-INITIALIZING	16384
BACS_STATE_MODULE-POLLING	32768

BACS_STATE_GENERAL_ALARM	65536
BACS_STATE_VOLTAGE_DIFF_HIGH	131072
BACS_STATE_BATTERY_BREAKER_OPEN	262144
BACS_STATE_THERMAL_RUNAWAY	524288
BACS_STATE_SENSOR_LOST	1048576

## I. EQUALINK MODBUS Parameter

### Standard EQUALINK – Address Description

Note: the max. number of EQUALINK Modules requestable through MODBUS is 330.

Note: “Type U/S”: this defines whether the answer has an algebraic sign (math. +/-) or not. U means “unsigned”. S means “signed”, this answer may be positive or negative.

Address	Type	Function	Name	Description	Length
1000	U	3 / 4	<RESERVED>	Reserved, do not use *4	1
1001	U	3 / 4	<RESERVED>	Reserved, do not use *5	1
1000	U	3 / 4	EQUALINK_ALARM_...	EQUALINK Alarm Flags (see alarm flag definition below) *6	1
1003	U	3 / 4	<RESERVED>	Reserved, do not use	1
...	...	...	...	...	...
1010	S	3 / 4	STRING_01_CUR	String 1 current in Ampere [A]	1
1011	S	3 / 4	<RESERVED>	Reserved, do not use	1
...	...	...	...	...	...
1015	S	3 / 4	STRING_02_CUR	String 2 current in Ampere [A]	1
...	...	...	...	...	...
1055	S	3 / 4	STRING_10_CUR	String 10 current in Ampere [A]	1
...	...	...	...	...	...
1060	S	3 / 4	MODULE_001_TEMP	Module 1 Temperature in Celsius [°C] (see Tempfjasdfashfklashf) *1	1
1061	S	3 / 4	MODULE_001_VOLT	Module 1 Voltage in Volt [V] *2	1
1062	S	3 / 4	MODULE_001_IMPC	Module 1 Impedance in milliOhm [mΩ] *3	1
1063	U	3 / 4	MODULE_001_ALARM	Module 1 Alarm flags *6	1
1064	S	3 / 4	MODULE_001_EQ	Module 1 Equalizing in Percent [%]	1
1065	S	3 / 4	MODULE_002_TEMP	Module 2 Temperature in Celsius [°C] *1	1
...	...	...	MODULE_x until No. 330.	...	...
2705	S	3 / 4	MODULE_330_TEMP	Module 330 Temperature in Celsius [°C] *1	1
2706	S	3 / 4	MODULE_330_VOLT	Module 330 Voltage in Volt [V] *2	1
2707	S	3 / 4	MODULE_330_IMPC	Module 330 Impedance in milliOhm [mΩ] *3	1
2708	U	3 / 4	MODULE_330_ALARM	Module 330 Alarm flags *6	1
2709	S	3 / 4	MODULE_330_EQ	Module 330 Equalisation in Percent [%]	1

**Note:** A value of -1 or -9999 means: This value is currently “Not available” (“N/A”).

**\*1 - Temperature value definition:**

**Temperature T in °C**       $T = \frac{X-78}{2}$       **e.g.**     $T = \frac{128-78}{2} = 25$

0xXX → 0 to 255  
 0x7F 127 => 24,5°C  
 0x80 128 => 25°C  
 0x81 129 => 25,5°C

**\*2 - Voltage value definition:**

**Voltage U in V**                      Value / 1000

e.g. **Voltage U in V** = 12825 / 1000 = 12,825 V

**\*3 - Impedance value definition:**

**Impedance Z in mΩ**    Value / 100

e.g. **Impedance Z in mΩ** = 4372 / 1000 = 43,72 mΩ

**\*4 – Address 1000 MODBUS/SNMP**                      (hexadecimal)                      (decimal)

BACS_STATE_NONE	0x0000	0
BACS_STATE_RUNNING	0x0001	1
BACS_STATE_CONNECTED	0x0002	2
BACS_STATE_MODULE_LOST	0x0004	4
BACS_STATE_DISCHARGING	0x0008	8
BACS_STATE_CHARGING	0x0010	16
BACS_STATE_DISCHARGING_STOPPED	0x0020	32
BACS_STATE_FLOAT_CHARGING	0x0040	64
BACS_STATE_EQUALISATION	0x0080	128
BACS_STATE_SYSTEM_FAILURE	0x0100	256
BACS_STATE_VOLTAGE_OUTOFRANGE	0x0200	512
BACS_STATE_TEMPERATURE_OUTOFRANGE	0x0400	1024
BACS_STATE_RESISTOR-OUTOFRANGE	0x0800	2048
BACS_STATE_MODULE-ADDRESSING	0x1000	4096
BACS_STATE_MODULE-SEARCHING	0x2000	8192
BACS_STATE_MODULE-INITIALIZING	0x4000	16384
BACS_STATE_MODULE-POLLING	0x8000	32768

**\*5 – Address 1001 MODBUS/SNMP**                      (hexadecimal)                      (decimal)

BACS_STATE-GENERAL-ALARM	0x0001	1
BACS_STATE-VOLTAGE-DIFF-HIGH	0x0002	2
BACS_STATE-BATTERY-BREAKER-OPEN	0x0004	4
BACS_STATE_THERMAL_RUNAWAY	0x0008	8

**\*6 – Address 1002 Alarm Flags MODBUS/SNMP** (hexadecimal)                      (decimal)

BACS_ALARM_NONE	0x0000	0
BACS_ALARM_GENERAL_ALARM	0x0001	1
BACS_ALARM_COMMUNICATION_LOST	0x0002	2
BACS_ALARM_VOLTAGE_HIGH	0x0004	4
BACS_ALARM_VOLTAGE_LOW	0x0008	8
BACS_ALARM_TEMPERATURE_HIGH	0x0010	16



BACS_ALARM_TEMPERATURE_LOW	0x0020	32
BACS_ALARM_RESISTOR_HIGH	0x0040	64
BACS_ALARM_RESISTOR_LOW	0x0080	128
BACS_ALARM_EQUALISATION_ERR	0x0100	256
BACS_ALARM_VOLTAGE_WARN_HIGH	0x0200	512
BACS_ALARM_VOLTAGE_WARN_LOW	0x0400	1024
BACS_ALARM_TEMPERATURE_WARN_HIGH	0x0800	2048
BACS_ALARM_TEMPERATURE_WARN_LOW	0x1000	4096
BACS_ALARM_RESISTOR_WARN_HIGH	0x2000	8192
BACS_ALARM_RESISTOR_WARN_LOW	0x4000	16384
BACS_ALARM_MODREV_INCOMPATIBLE	0x8000	32768

## J. EQUALINK Maintenance

Generally the EQUALINK Webmanager firmware should be updated regularly. Check the "firmware update link" for new versions.

Critical updates are shown in red; feature updates are shown in green. The EQUALINK measuring cables and EQUALINK bus communication cables require no maintenance. In case a fuse is blown in the EQUALINK measuring cables, the complete cable has to be replaced. The EQUALINK C modules itself should be kept clean and dry. In dusty or humid environments the EQUALINK cabinets and the PCB inside should be cleaned in regular terms with compressed air.

Blow compressed air through the ventilation holes from both sides for some seconds to remove infiltrated dust or dirt through the opposite ventilation holes.

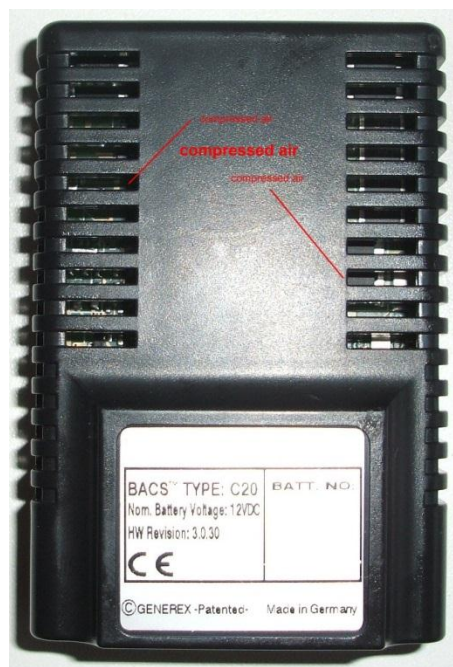

Figure 90: EQUALINK C Module Top View

After several years of operation in dusty/dirty environments the temperature sensor board may lose contact. To remove this problem disconnect the EQUALINK C sensor from the measuring cable and open the EQUALINK cabinet. Remove the EQUALINK main board and clean the contacts between temperature

sensor board and main board. Clean the dust box underneath the main board and re-assemble the cleaned C module.



Figure 91: EQUALINK C Module Main Board and Dust Box

#### **K. CS121/EQUALINK WDP – Watchdog & Powermanager**

The CS121 WDP is an optional Watchdog & Powermanager piggyback board for the CS121/EQUALINK series. It is a separate chipset, which can be attached to a CS121/BASC and it works as a Hardware watchdog to reset (cold boot) the processor, if a heartbeat signal is not received in an interval of 60 seconds.

**Watchdog function:** The watchdog starts 5 minutes after the CS121 has rebooted. If the Watchdog does not receive, within 120 seconds, a live signal from the processor, it will disconnect the power supply for a reset.

**Powermanager function:** Additionally this device checks the input power supply and blocks the startup of the processor until the power supply is stabilized and has reached at least a level of 8 Volts. This avoids startup problems at non stabilized power supplies or other power supply problems in UPS slots.

This product is designed to work as add-on for all CS121 based products with an internal connector such as all EQUALINK WEBMANAGER, CS121 SC,L,SCM,LM and the CS121 series with 16MB flash ROM built after 2010.

**Installation:** To mount the CS121WDP Piggy Board on the CS121 Board, be sure that the power supply is disconnected. Plug the CS121WDP Board on the CS121-Board like in the below pictures. The Piggy Board runs without any configuration and starts his functions immediately after connection. For using the Watchdog functionality, a firmware release after FW 4.28 is required. The Powermanager function is not depending on any FW level.

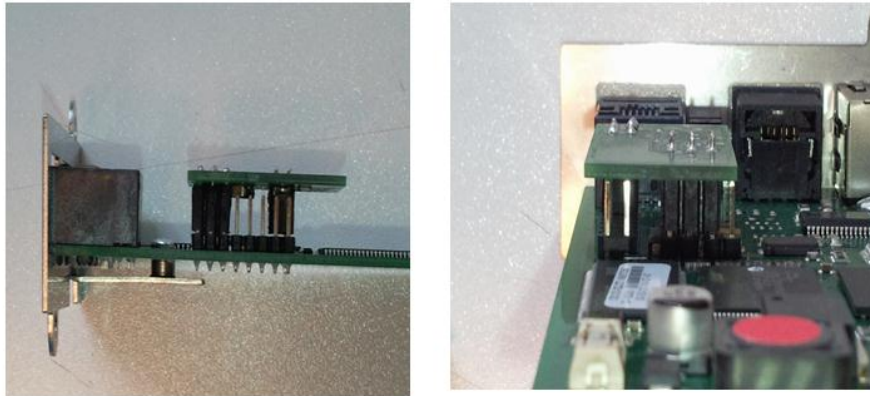

Figure 92: CS121/EQUALINK WDP installed on a CS121/EQUALINK board – view from left and behind

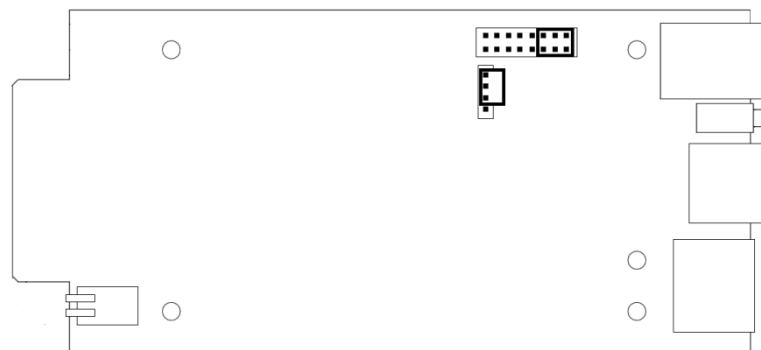

Figure 93: CS121/EQUALINK WDP connecting PINs on a CS121/EQUALINK board – top view

## L. Table of Figures

Figure 1: Diagram of a typical EQUALINK system setup.....	6
Figure 2: EQUALINK WEBMANAGER typical setup .....	7
Figure 3: EQUALINK C20 REV 1.4/2.2 Module – EQUALINK C20 REV 3 Module.....	8
Figure 4: EQUALINK WEBMANAGER external kit (left), slot version kit (right), with spare cables ..	8
Figure 5: EQUALINK WEBMANAGER II with integrated EQUALINK CONVERTER .....	9
Figure 6: Overview of optional modules for an EQUALINK system .....	9
Figure 7: EQUALINK RAS WEBMANAGER II with integrated modem.....	9
Figure 8: Typical assembling of an EQUALINK Measuring Cable .....	10
Figure 9: Assembling and Connection of the Module .....	11
Figure 10: EQUALINK bus cables (Part No. B2BCRJ10xx) connected to an EQUALINK CONVERTER .....	12
Figure 11: EQUALINK bus cables connected to an EQUALINK WEBMANAGER II internal CONVERTER .....	12
Figure 12: EQUALINK bus cables connected to an EQUALINK WEBMANAGER Slot version - For usage with UPS, Inverters, Rectifiers, Chargers or other devices with such a compatible slot type .....	12
Figure 13: EQUALINK SPLITTING BOX .....	13
Figure 14: EQUALINK bus cables connected to a SPLITTBOX - CONVERTER – EQUALINK WEBMANAGER.....	13
Figure 15: EQUALINK WEBMANAGER II typical setup .....	14
Figure 16: EQUALINK Webmanager II with integrated CONVERTER.....	14
Figure 17: EQUALINK Bus Converter III for use with EQUALINK WEBMANAGER slot cards and External.....	14
Figure 18: EQUALINK WEBMANAGER external, this is also available as SLOT card for UPS.....	15
Figure 19: (1) Connection PC-Switch/Hub and CS121 (2) Connection PC-Cross-Cable/Network Cable and CS121.....	16
Figure 20: EQUALINK WEBMANAGER SLOT card for UPS .....	17

Figure 21: EQUALINK Battery Information .....	19
Figure 22: Enter Number of Batteries .....	20
Figure 23: EQUALINK Feature “List module numbers string wise” .....	20
Figure 24: Alarm Logfile with temperature alarm on EQUALINK modules with string numbers .....	20
Figure 25: Web Interface EQUALINK Configuration .....	21
Figure 26: Web-Interface EQUALINK Setup & Tools .....	22
Figure 27: EQUALINK Web-Browser Programming Interface - Finished Addressing Process .....	23
Figure 28: EQUALINK Start-Up Screen (64 Modules) .....	23
Figure 29: Web-browser EQUALINK Status Page (64 Modules) .....	24
Figure 30: Reset to Factory Settings .....	26
Figure 31: EQUALINK Module & Alarm Settings .....	26
Figure 32: Web-Browser EQUALINK Status Page showing Balancing Activity .....	28
Figure 33: Web-Browser EQUALINK Status Page showing Balancing Activity per Module .....	29
Figure 34: Web-Browser EQUALINK Status Page showing Balancing Activity Display per Module .....	29
Figure 35: Sort function – sort Web-browser EQUALINK Status Page by Voltage, Temperature or Impedance .....	31
Figure 36: EQUALINK Module HW Revision Mismatch .....	31
Figure 37: EQUALINK Status – Further Information .....	32
Figure 38: BUS CONVERTER Alarm Buzzer/Contact Configuration .....	32
Figure 39: EQUALINK Selection/Configuration .....	33
Figure 40: Add EQUALINK Device .....	34
Figure 41: EQUALINK Settings, FTP .....	34
Figure 42: EQUALINK Autosynchronization .....	34
Figure 43: EQUALINK Device Selection Autosync enabled .....	35
Figure 44: Synchronization of the EQUALINK Data .....	35
Figure 45: EQUALINK “Delete EQUALINK Files” Function .....	36
Figure 46: EQUALINK Import of Files .....	37
Figure 47: EQUALINK Viewer script parameters for the automatic download .....	37
Figure 48: EQUALINK String Selection .....	38
Figure 49: EQUALINK Time Range Selection .....	39
Figure 50: EQUALINK voltage analysis, showing alarm thresholds as red horizontal line .....	39
Figure 51: EQUALINK Selection Discharge .....	40
Figure 52: EQUALINK deepest discharge point shown are vertical red dotted line .....	40
Figure 53: EQUALINK dashed vertical red line shows the end of this discharge process and related voltages of every battery at this point .....	41
Figure 54: EQUALINK Tool “Reset Zoom” .....	42
Figure 55: EQUALINK coloured Module Identification .....	43
Figure 56: EQUALINK Suppress Recording Gaps Feature enabled .....	43
Figure 57: EQUALINK Suppress Recording Gaps Feature disabled .....	44
Figure 58: EQUALINK “Highlight” Function .....	44
Figure 59: EQUALINK “Isolate” function, hiding all other battery lines .....	45
Figure 60: Current curve of string 1 and 2 during discharge/charge .....	46
Figure 61: Battery temperature rise and fall due to environmental influence or discharges .....	47
Figure 62: Increase of impedance showing aging of batteries and defects .....	48
Figure 63: Impedance Baseline with small change .....	50
Figure 64: Impedance Baseline with course into warning area .....	50
Figure 65: Impedance Baseline with Measuring Error .....	51
Figure 67: EQUALINK Viewer Menu Edit/Settings .....	53
Figure 68: EQUALINK “Export” Function to CSV file format .....	53
Figure 69: EQUALINK Recording Gaps .....	54
Figure 70: EQUALINK “Fixed Scaling” Function on/off .....	54
Figure 71: EQUALINK “View Status” Overview page showing all events and alarms on this system .....	55
Figure 72: EQUALINK BUS CONVERTER II .....	55
Figure 73: PIN Layout CS121 Config-Cable to Windows PC with EQUALINK Programmer Software .....	56
Figure 74: EQUALINK BUS CONVERTER III .....	56
Figure 75: Set System Time manually .....	56

Figure 76: PIN Layout CS121 Config-Cable to Windows PC with EQUALINK Programmer Software .....	57
Figure 77: EQUALINK SPLITTING BOX .....	57
Figure 78: EQUALINK_CS300 and EQUALINK_CS_500 DC current sensor .....	57
Figure 79: EQUALINK_CSxxx.....	58
Figure 80: EQUALINK_CSxxx Typ CS_II.....	59
Figure 81: EQUALINK_CSxxx Typ CS_III.....	60
Figure 82: EQUALINK Control Cabinet .....	60
Figure 83: Cable Assembling at Rack Battery .....	67
Figure 84: Backup Configuration .....	69
Figure 85: EQUALINK Webmanager FTP-Connection .....	70
Figure 86: Web Interface System Information .....	70
Figure 87: Web Interface Firmware Update Page .....	71
Figure 88: Firmware Update Warning .....	71
Figure 89: EQUALINK SNMP Polling .....	75
Figure 90: EQUALINK C Module Top View .....	78
Figure 91: EQUALINK C Module Main Board and Dust Box .....	79
Figure 92: CS121/EQUALINK WDP installed on a CS121/EQUALINK board – view from left and behind.....	80
Figure 93: CS121/EQUALINK WDP connecting PINs on a CS121/EQUALINK board – top view..	80



N56 W16665 Ridgewood Drive  
Menomonee Falls, WI 53051  
Phone: 262-703-5800  
Fax: 262-703-3073

Rev. 02-16TAEQIO